



Birlea

Suppliers of inspiration

Vendor: S000267



ASSEMBLY INSTRUCTIONS

IMPORTANT: READ THESE INSTRUCTIONS CAREFULLY BEFORE ASSEMBLING OR USING YOUR CHAIR.

PLEASE KEEP THESE INSTRUCTIONS FOR FUTURE REFERENCE.

HEALTH & SAFETY:

DO NOT jump or stand on this chair.

DO NOT use this chair if any parts are missing, damaged or worn.

DO NOT use this chair unless all fixings are secured.

Please keep small parts out of reach of children.

This chair should be used for seating one person at a time.

Always use on a level, even surface.

CARE & MAINTENANCE:

Assemble in the room of use.

Assemble on a soft, clean surface.

Periodically check all screws & fixings to ensure they are secure.

DO NOT push the chair as this will damage the legs.

Always lift the chair with two people to reposition.

Keep any sharp objects away from the chair.







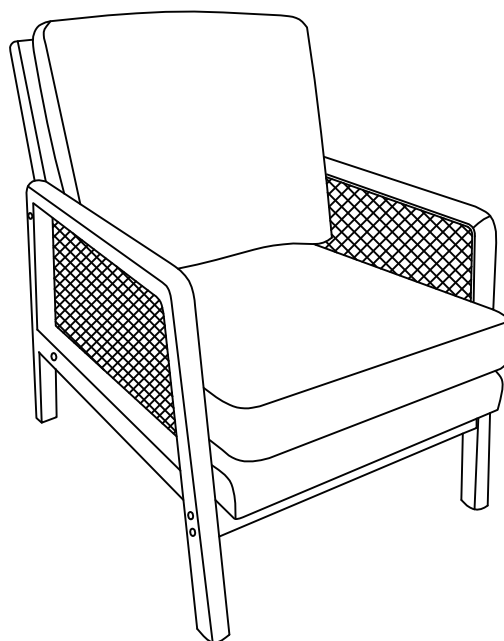

Clean with a damp, not wet, cloth.

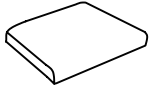
This product may stain or mark if allowed to come into contact with wet or damp objects as it has not been treated with scotch guard.

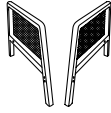
The surface of this chair is not heat resistant.



www.birlea.com

A×1  Back Panel	B×1  Seat Platform	C×1  Back Cushion	D×1  Seat Cushion	E×2  Arm Panel	F×1  Crossbar
G×10  Bolt	H×2  Washer	I×8  Bolt Cap	J×4  Self-Adhesive Pad	K×1  Allen Key	

①

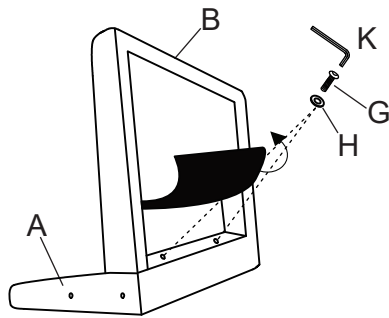
**Step 1:**

Place the seat platform (B) on the back panel (A) and lock it with bolts (G)(H).

②

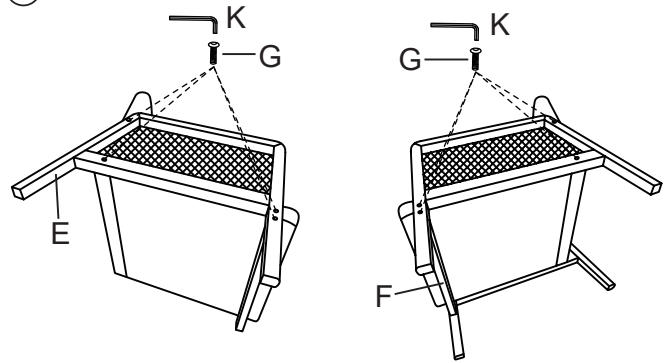
**Step 2:**

Place the arm panel (E) on the back panel and seat platform, lock it with bolts (G), and then lock the crossbar (F) with bolt (G). Place the other arm panel (E) on the back panel and seat platform, lock with bolts (G). Lock in cross bar using bolt (G).

③

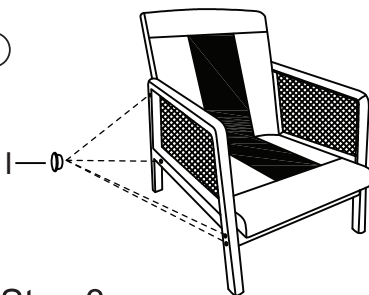
**Step 3:**

Insert the bolt caps (I) into the arm panel. Attach the self-adhesive pads (J) to the bottom of the legs.

④

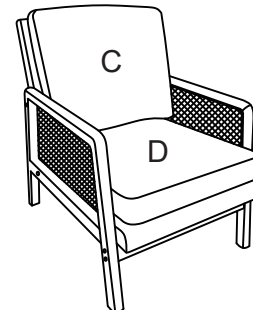
**Step 4:**

Place the seat cushions (D) and the back cushions (C) onto the sofa. Assembly is complete.

Please Note: When moving the sofa please make sure to hold the side and bottom. Be careful not to grip any fragile spots where they may easily be damaged

Additional Information:

- For complete product information, images and dimension diagrams please visit the website www.birlea.com
- If you have any issues with your item please contact the retailer directly you purchased it from who will be able to resolve any issues with Birlea.
- Why don't you send us photos of your assembled furniture to info@birlea.com to be shared in our #birleahome feature on Instagram.