

ASSEMBLY INSTRUCTIONS

150CM OTTOMAN BED

Approximate Assembly Time



People Required to Assemble



Tools Required

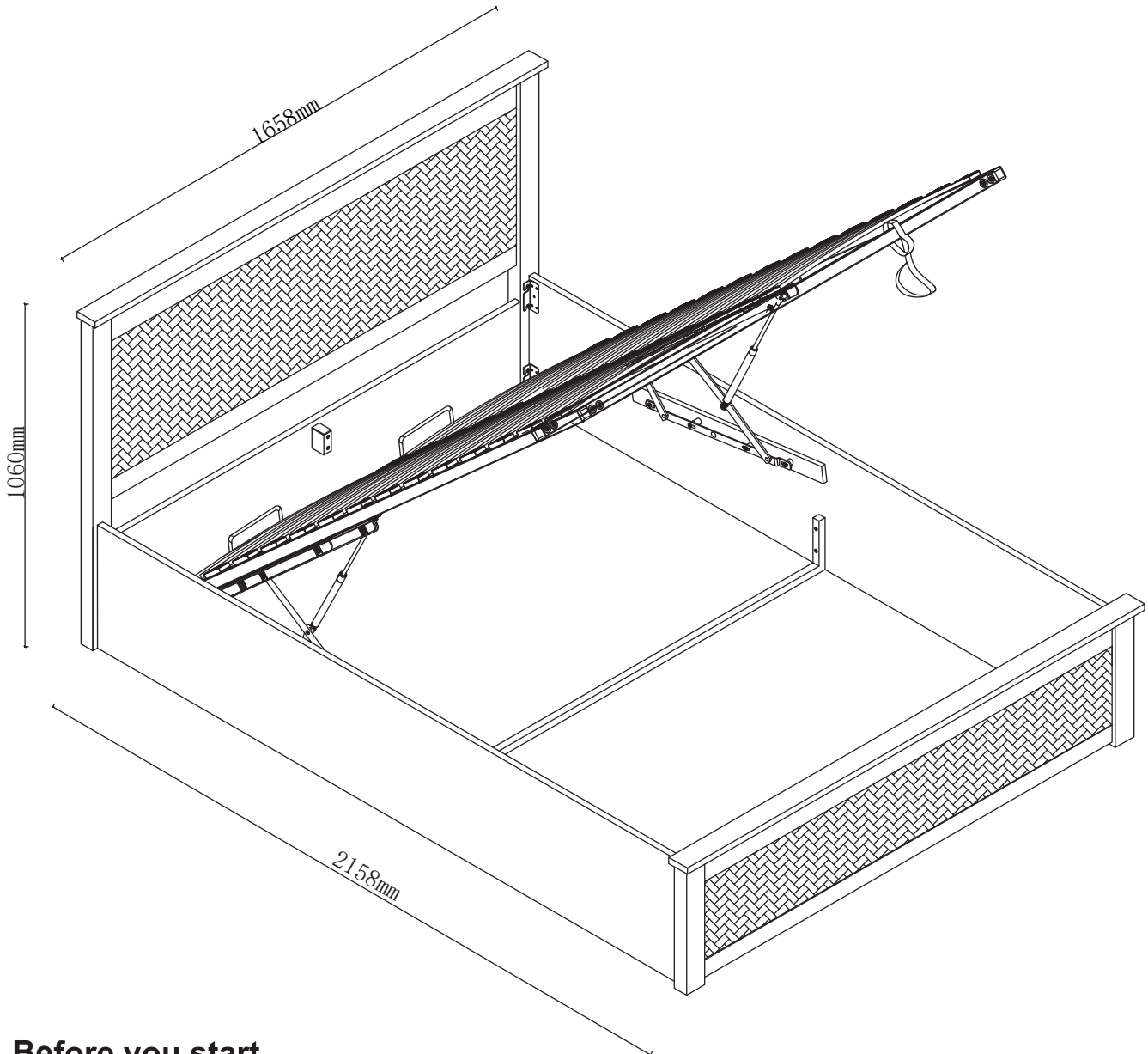

Before you start...

Please carefully unpack and lay out all of the component parts to ensure nothing is missing and to check each component for any obvious damage.

Should you identify any concerns at this stage please contact the retailer from whom this product was purchased. Please quote your order number, details of your issue, the product code, and the batch number from the cartons which will help to resolve your issue as quickly as possible.

Version Number - 1.0

Product Code-PAD012/PAD112 01

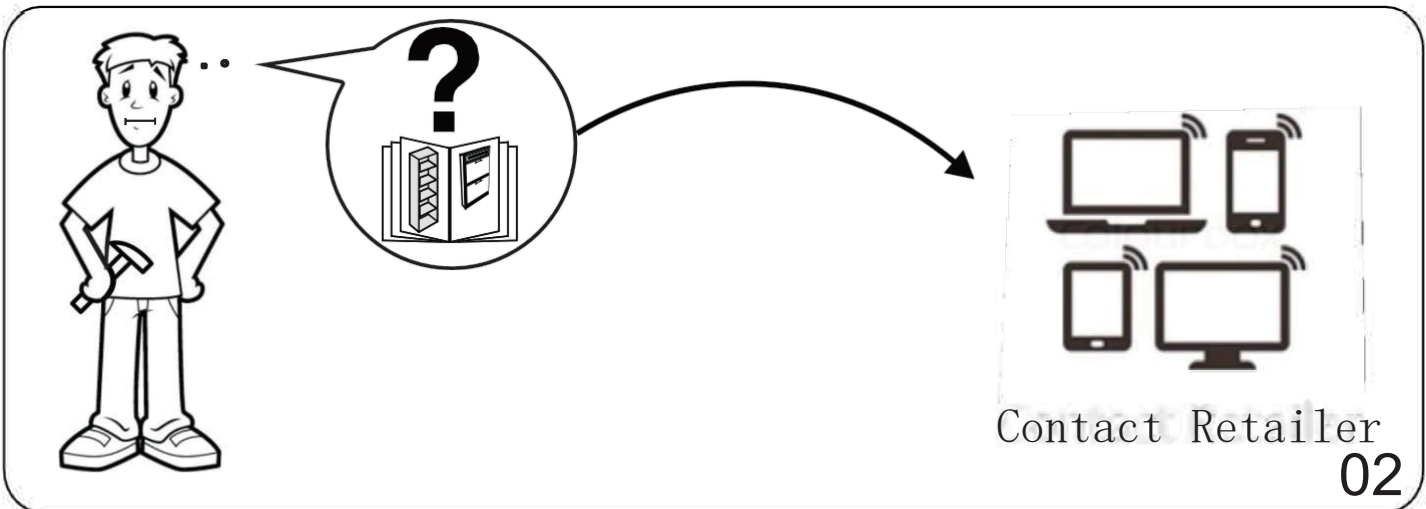
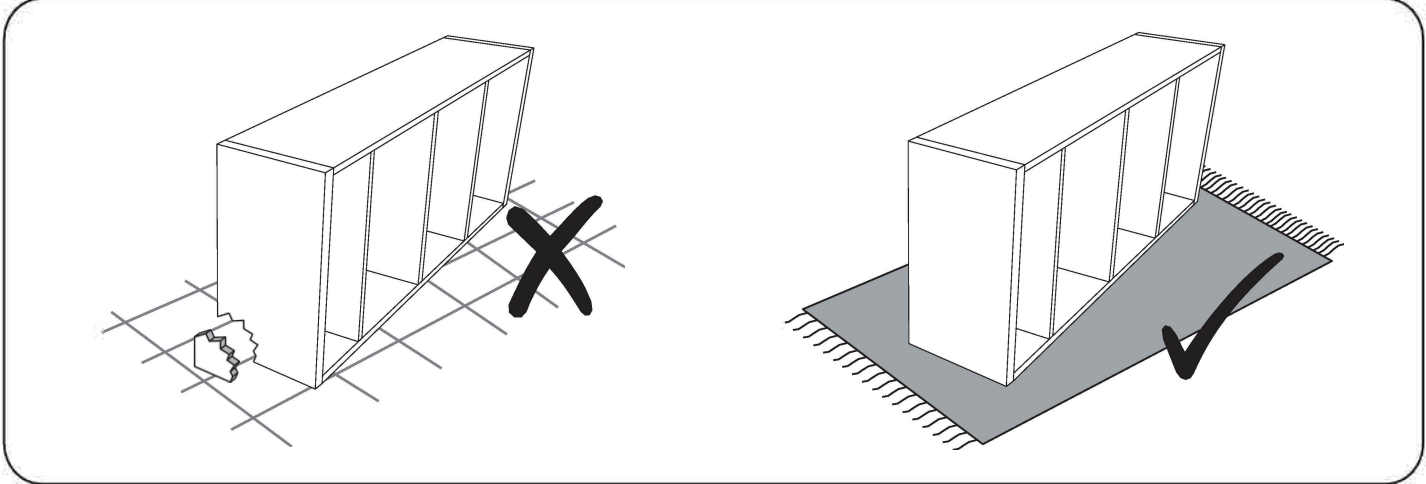
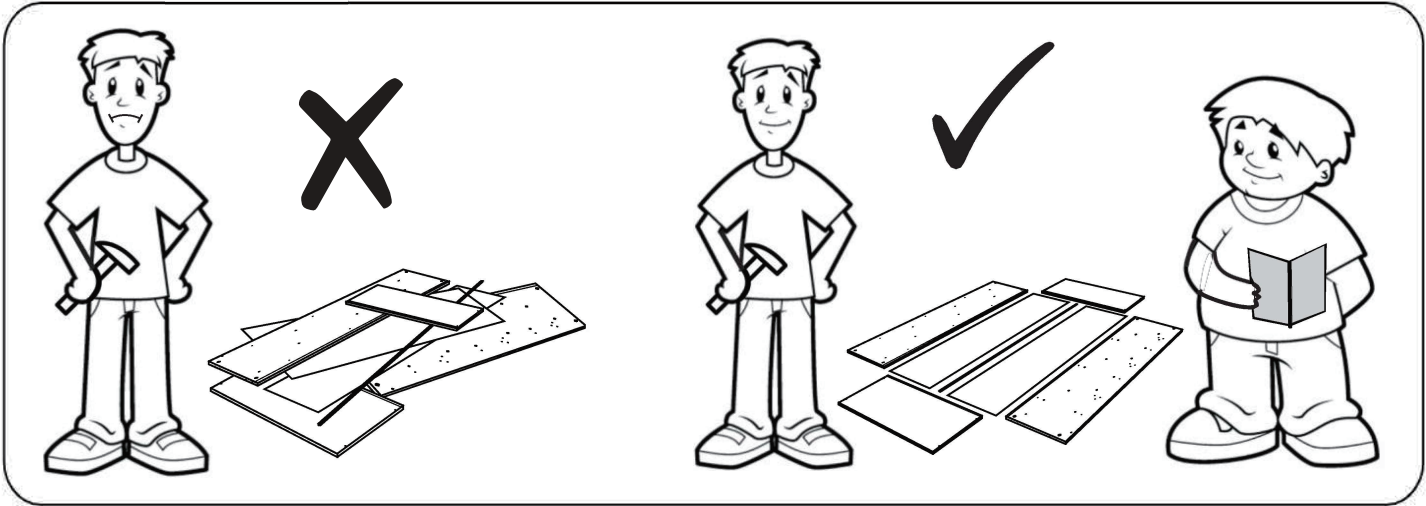
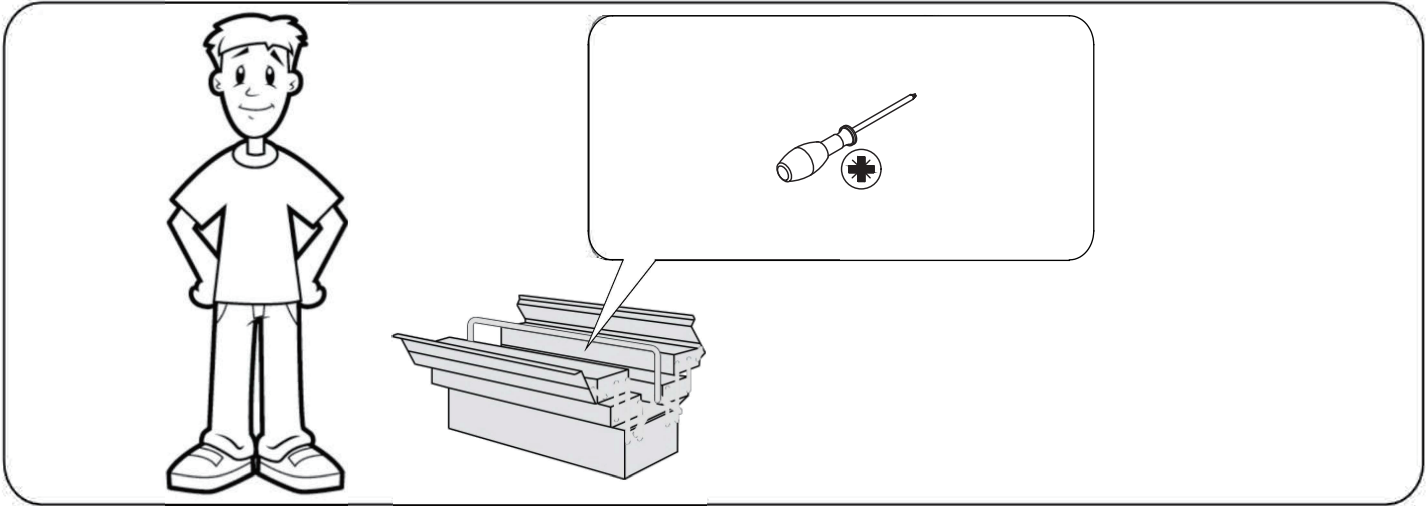

Please check all the hardware matches the list below should you notice any are missing please contact your retailer.

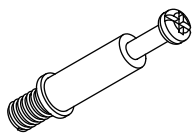

A

10 x M6x35



B

10 x Ø15x12



C

8 x M8x15



D

36 x M8x20



E

8 x M8x40

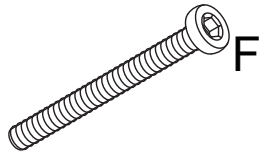

F

4 x M8x65

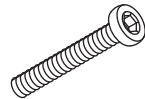

G

4 x M8x35



H

28 x



I

28 x

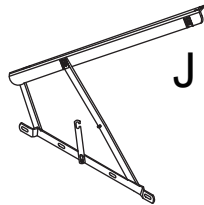

J

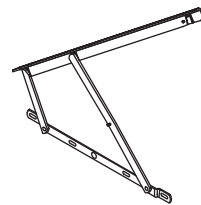

K

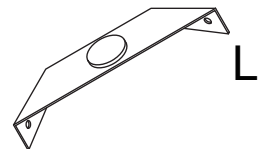

L

2 x

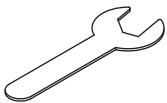

M

M8



N

M5



O

4 x M8

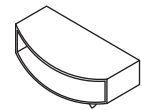

P

30 x

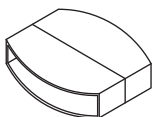

Q

15 x

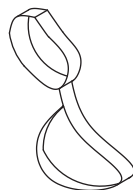

R



S

10 x

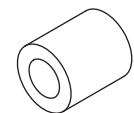

T

8 x

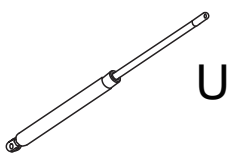

U

2 x

We strongly advise that you do not use Power Tools, such as drills or electric screwdrivers during the assembly as this may cause irreparable damage and will invalidate your warranty.



PARTS

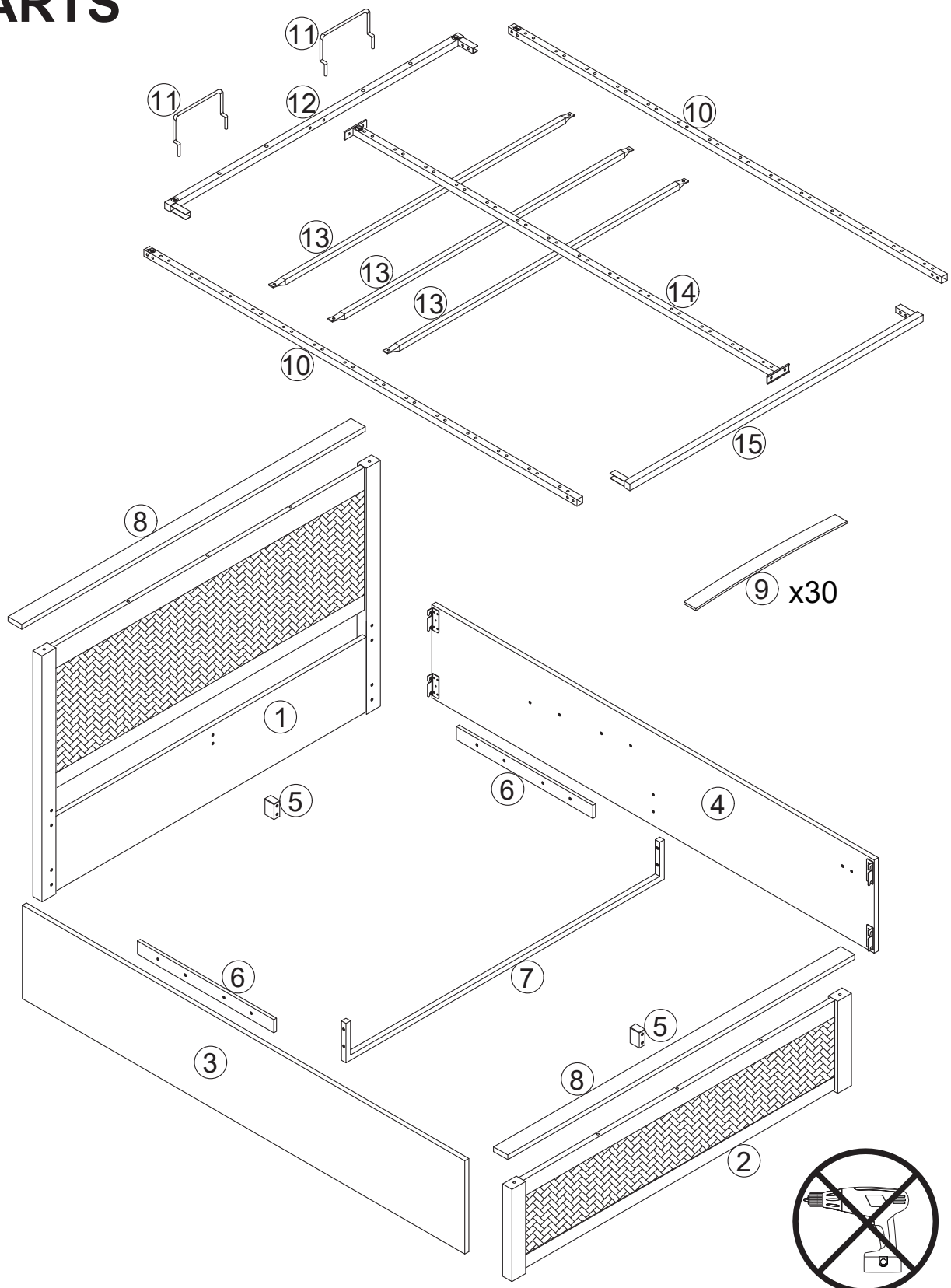

Please ensure you carefully check all the pieces, should you have any concerns please contact the retailer before assembly commences. Please have your order number, details of the issue, the product code, and the batch number from the cartons as this will help us to resolve your issue much faster.

ASSEMBLY ADVICE

Please take the time to carefully read through these instructions before you commence.

Keep these instructions for future reference.

We advise that the product is assembled in the room it is intended for.

We advise that you keep the hardware in a bowl during assembly to avoid losing anything.

We strongly recommend that you keep children away from the work area.

Small component parts could choke a child if swallowed.

We recommend you use a sheet or blanket to protect both floor and product through the assembly stages.

This product is heavy, and we recommend a 2 person lift to avoid personal injury or damage to the product.

Never push or pull the product as this could cause both personal injury or irreparable damage to product or floor.







We have tried to make this piece of furniture easy to assemble if the instructions are followed carefully.

In the unlikely event that you have problems with assembling the product or have missing or damaged parts, please contact your retailer and we will assist them in rectifying the problem as quickly as possible.

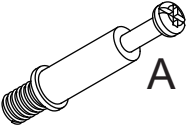
Please remember we strongly urge you DO NOT use power tools such as drill or electric screwdrivers as this could cause irreparable damage to your product and will invalidate your warranty.

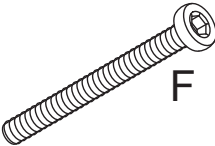





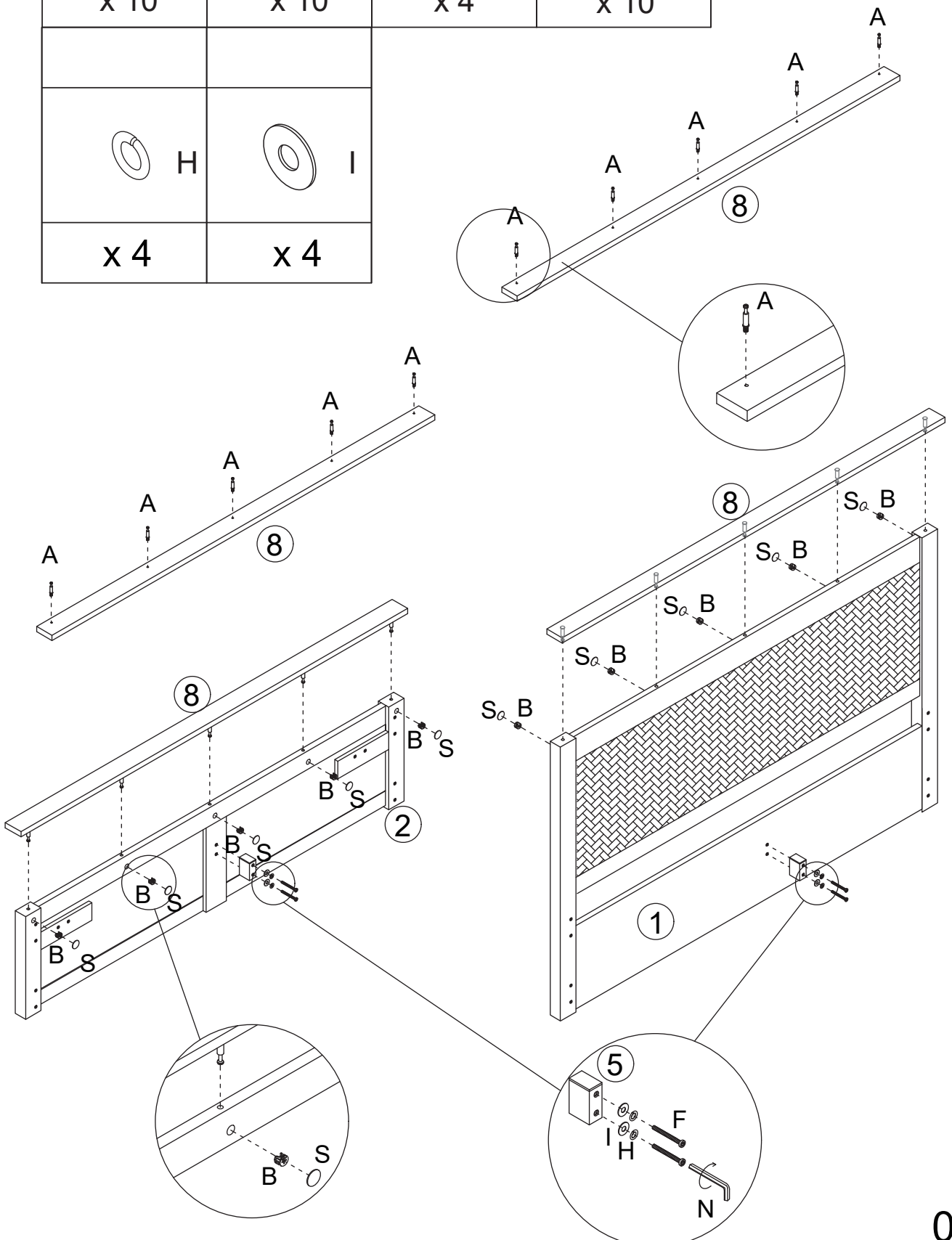
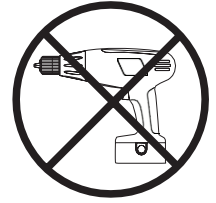

1

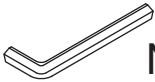
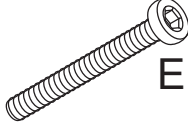
M6x35	Ø15x12	M8x65	
 A	 B	 F	 S
x 10	x 10	x 4	x 10
 H	 I		
x 4	x 4		



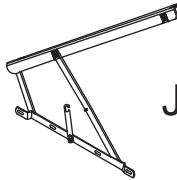

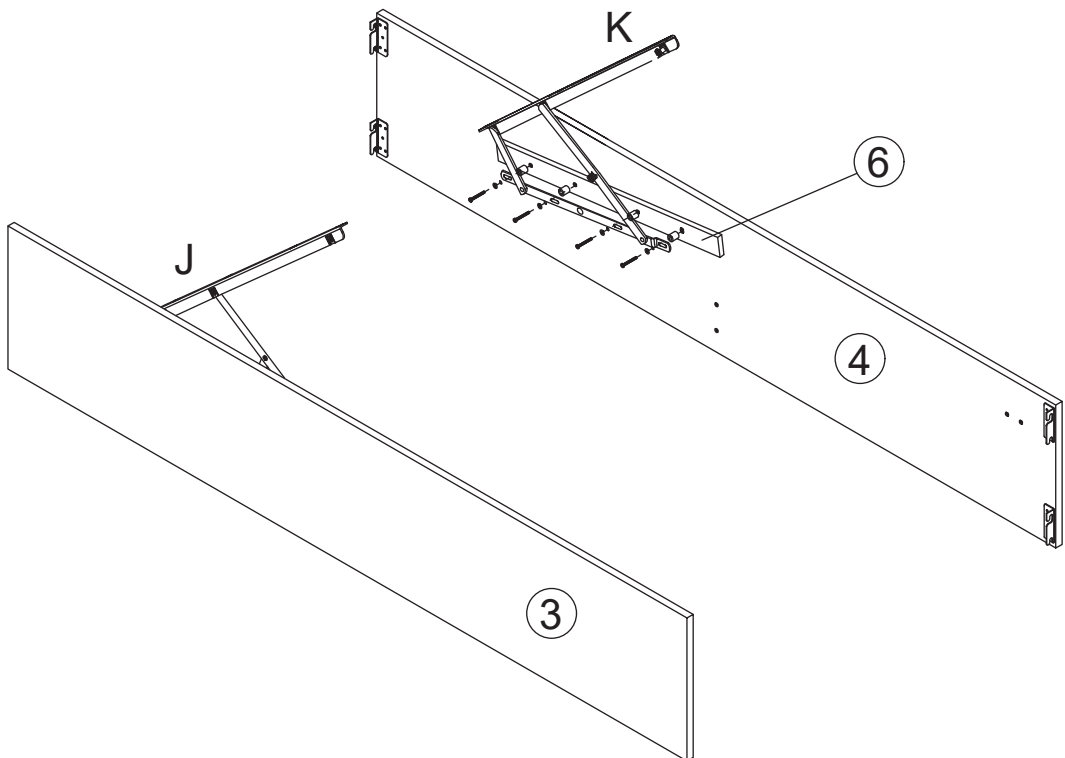
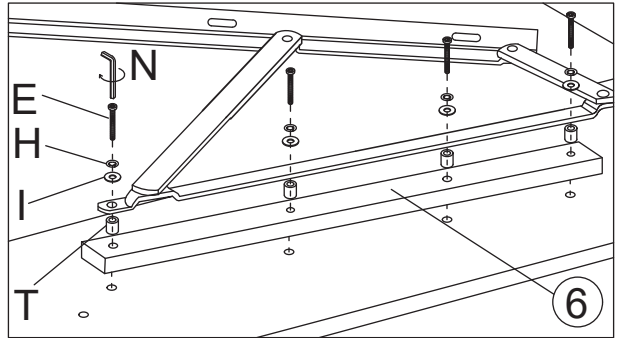
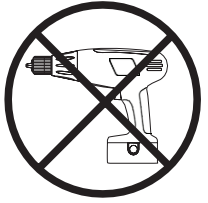

2

M5	M8x40		
 N	 E	 H	 I
x 1	x 4	x 4	x 4
 T	 J	 K	
x 4	x 1	x 1	

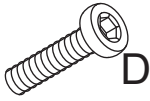

3

M8x20	M8x35		
			
x 16	x 4	x 4	x 4

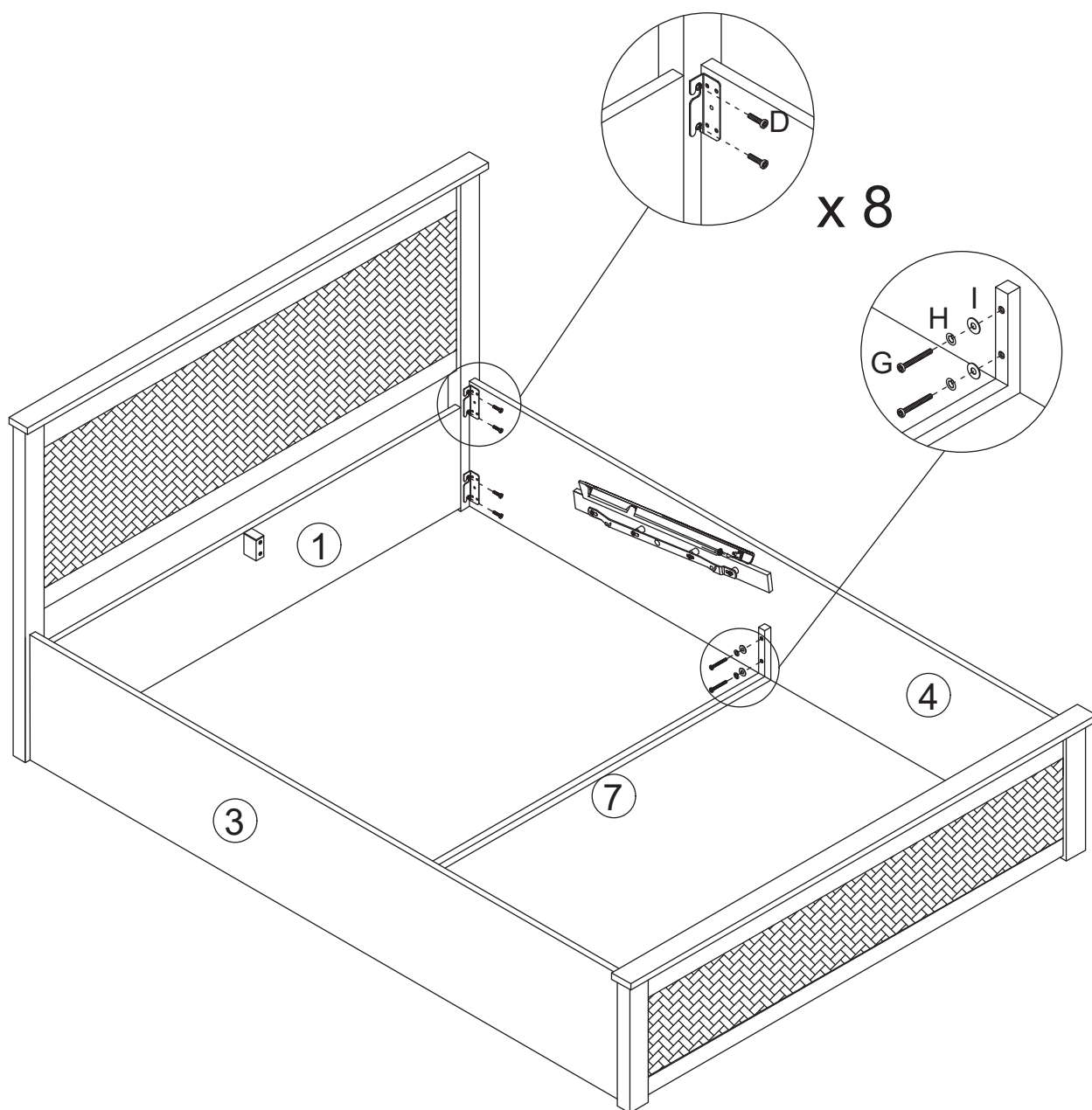
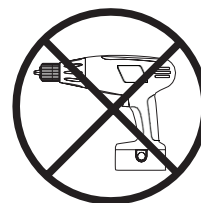



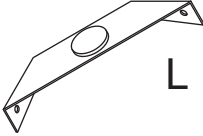

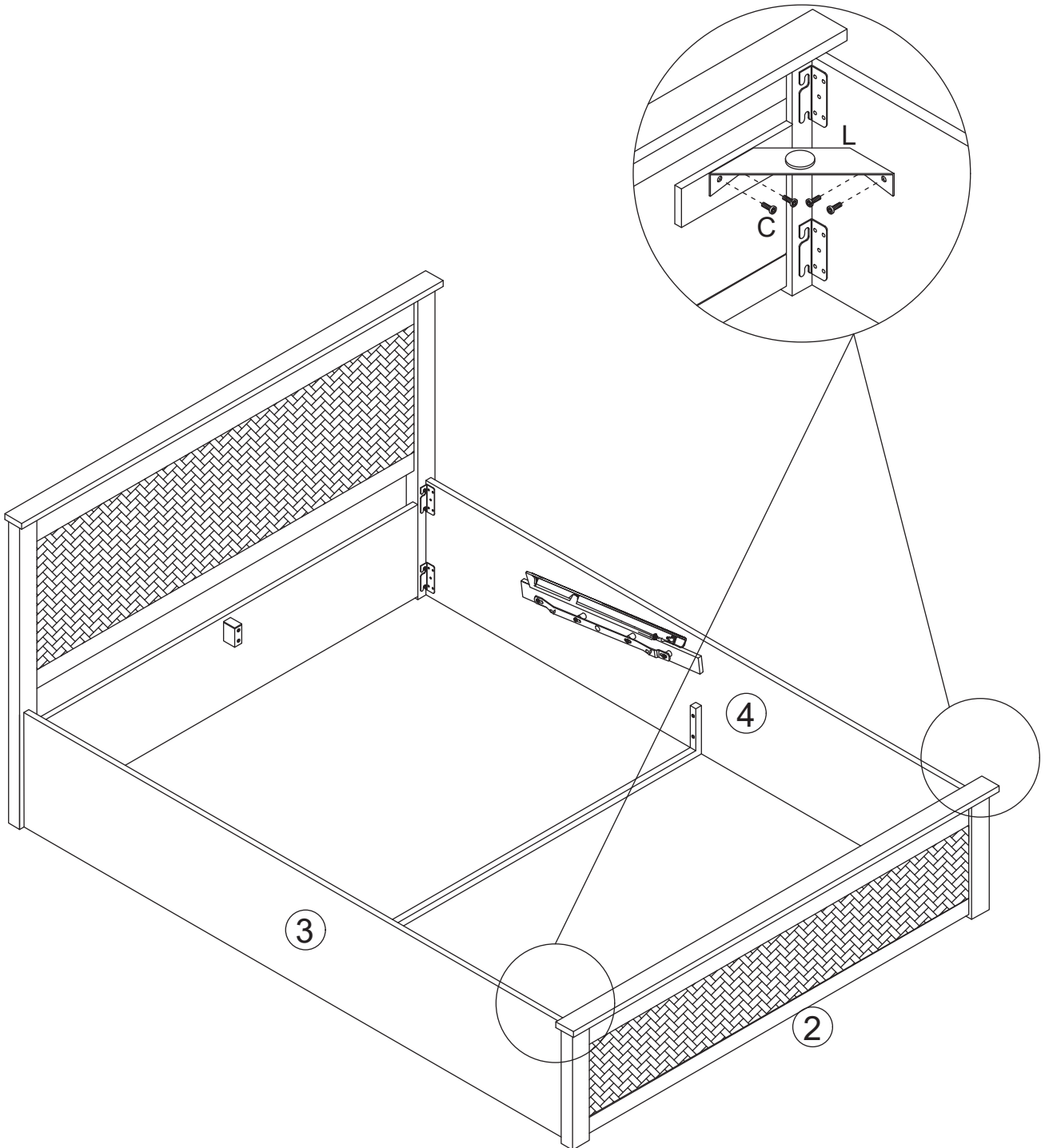
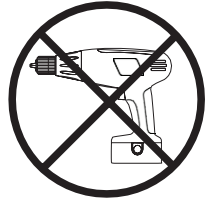
4

M8x15	
	
x 8	x 2



5

M8x20			
 D	 H	 I	 R
x 12	x 12	x 12	x 1

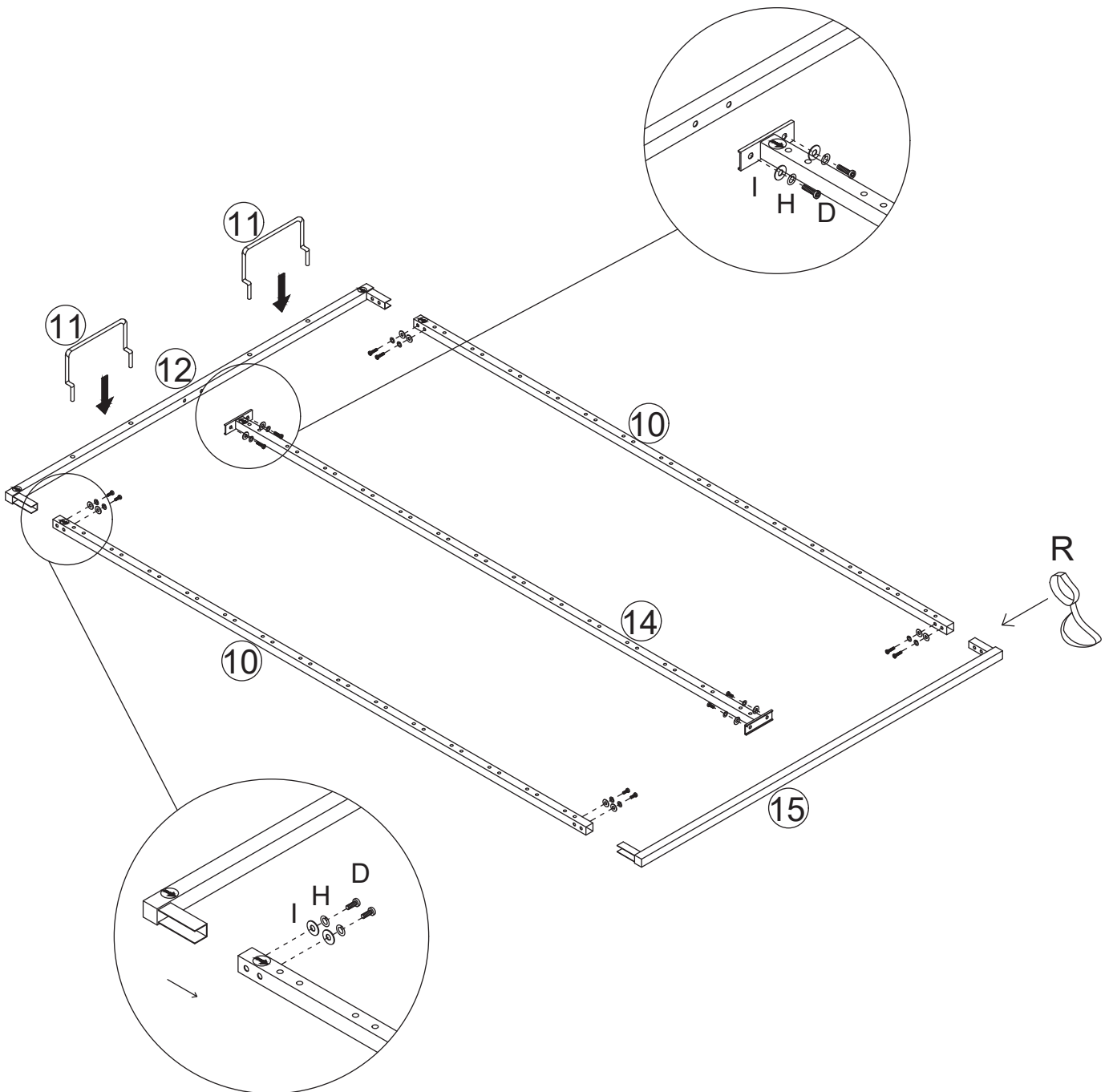
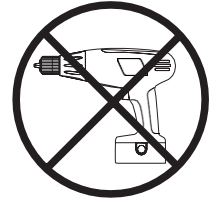

6

M8x20

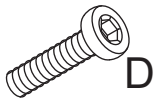

x 8

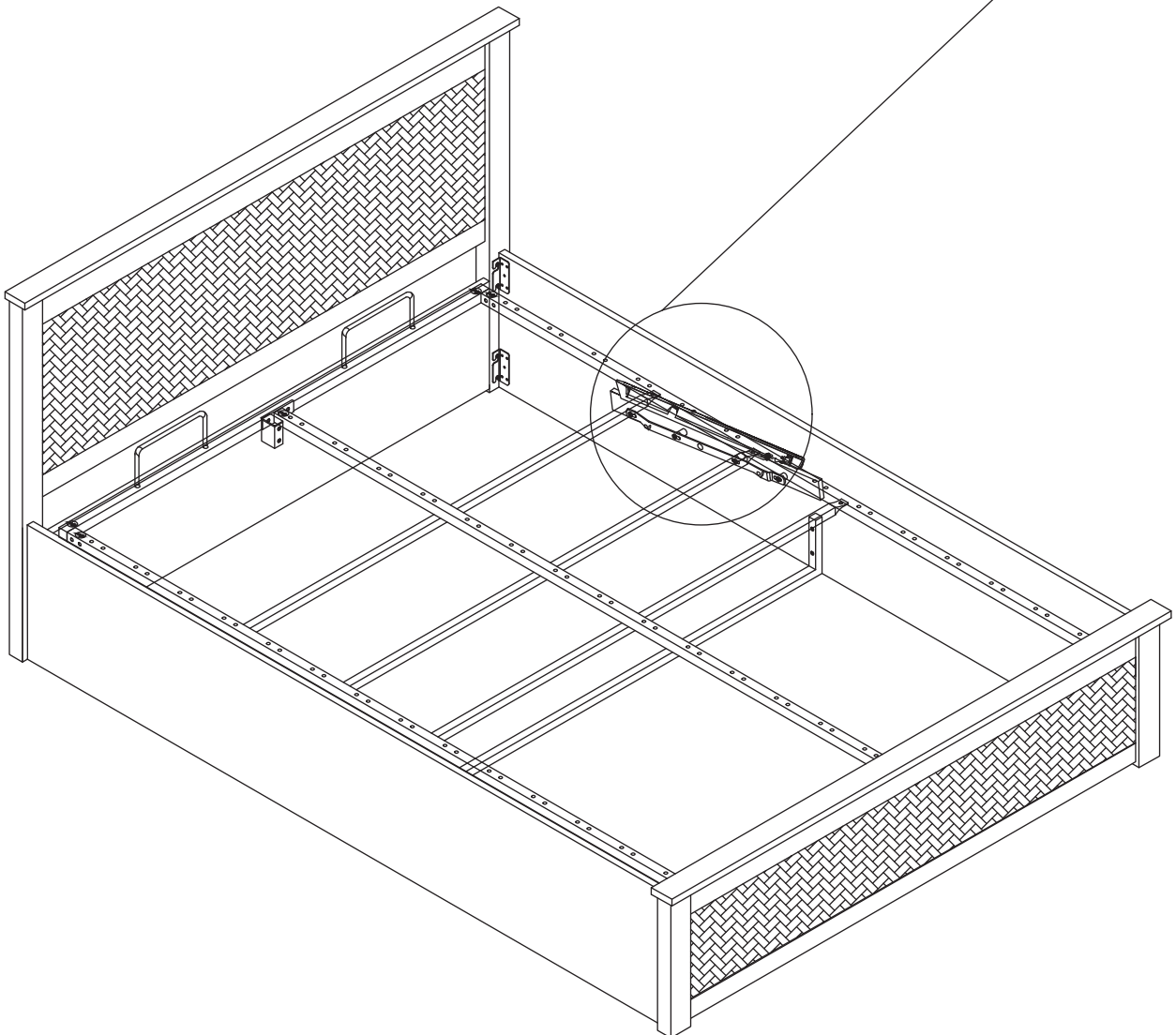
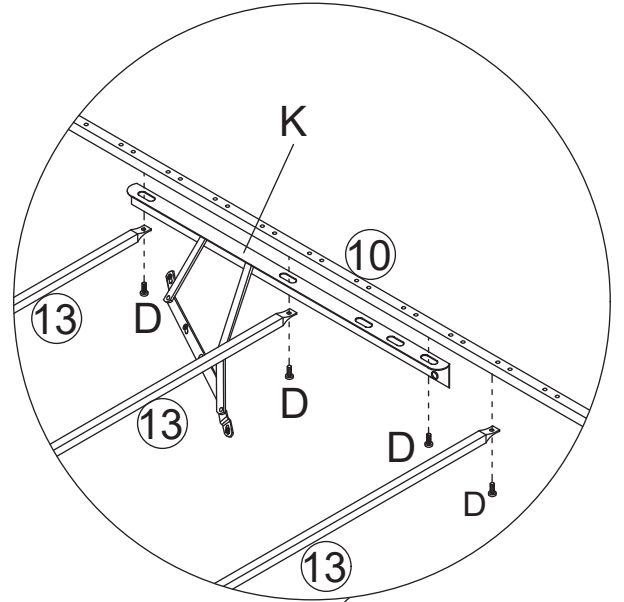
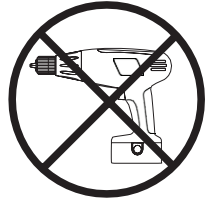

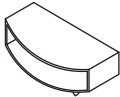
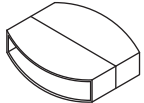

7

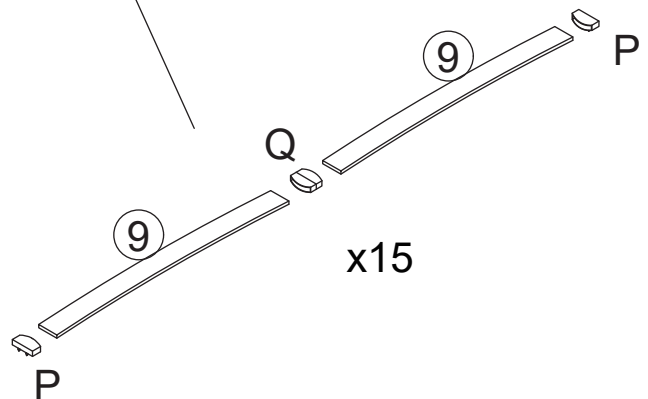
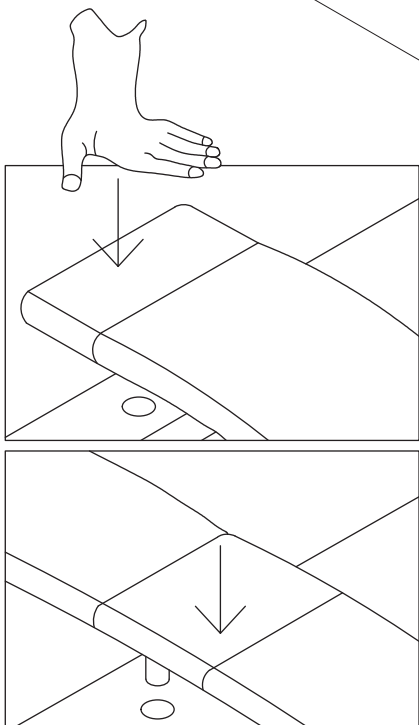
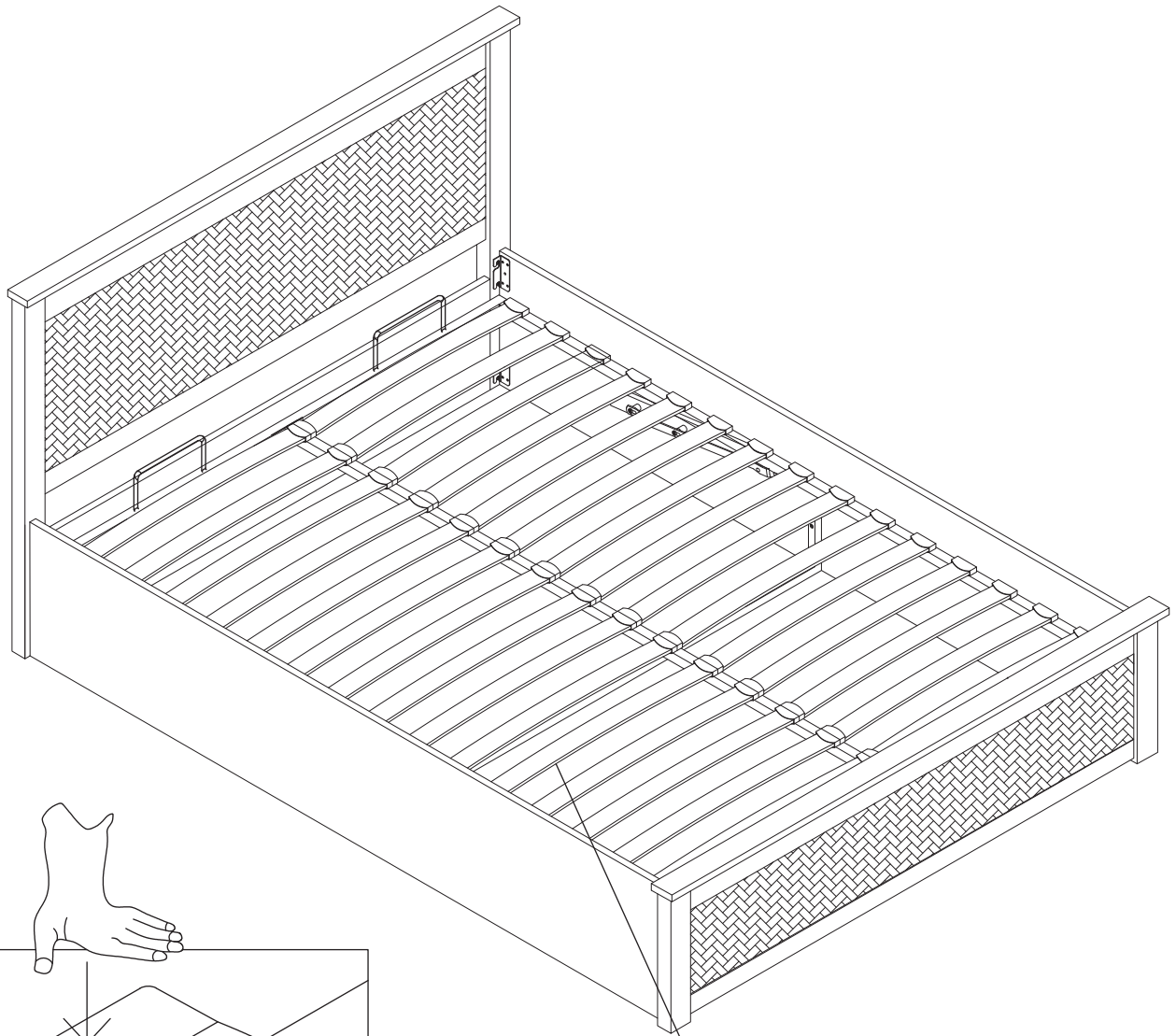
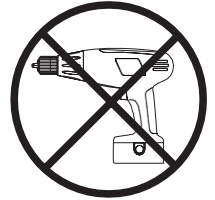
 P	 Q
x 30	x 15

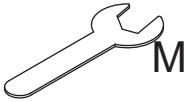

8

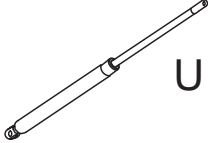
M8	M8	
 M	 O	 U
x 1	x 4	x 2

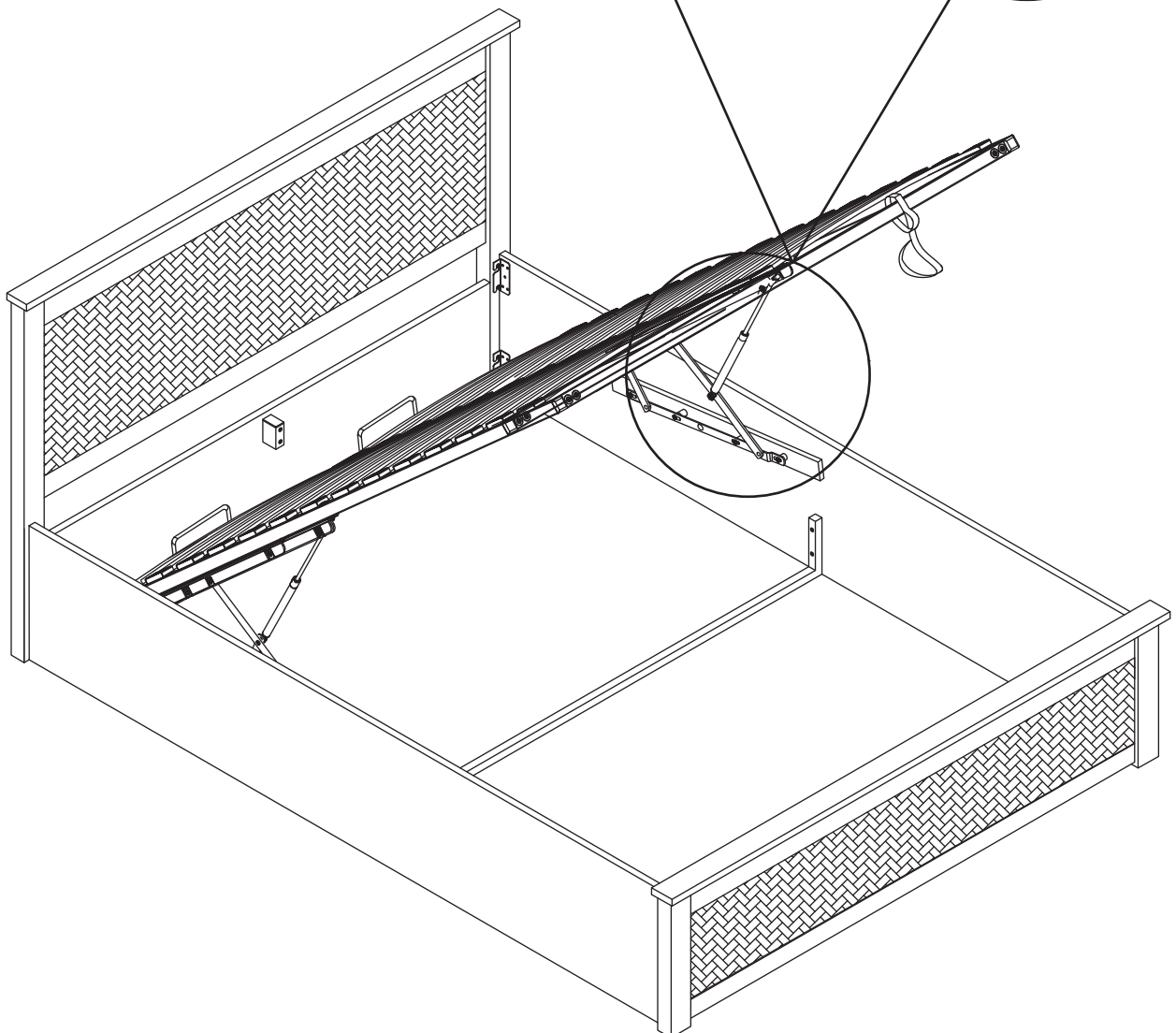
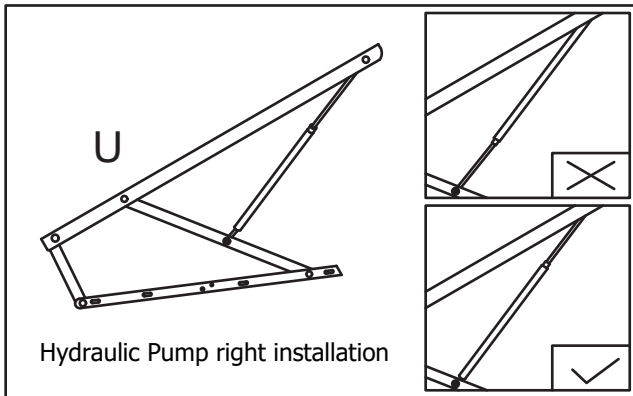
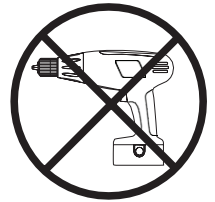

9

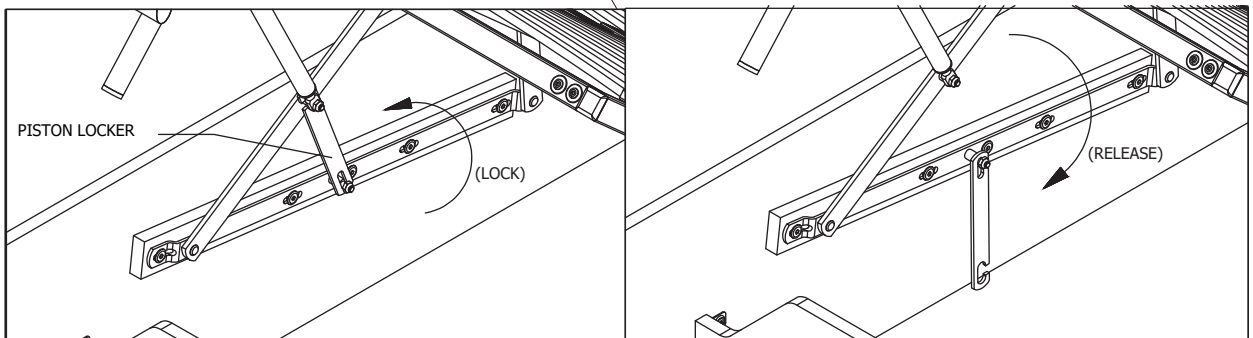
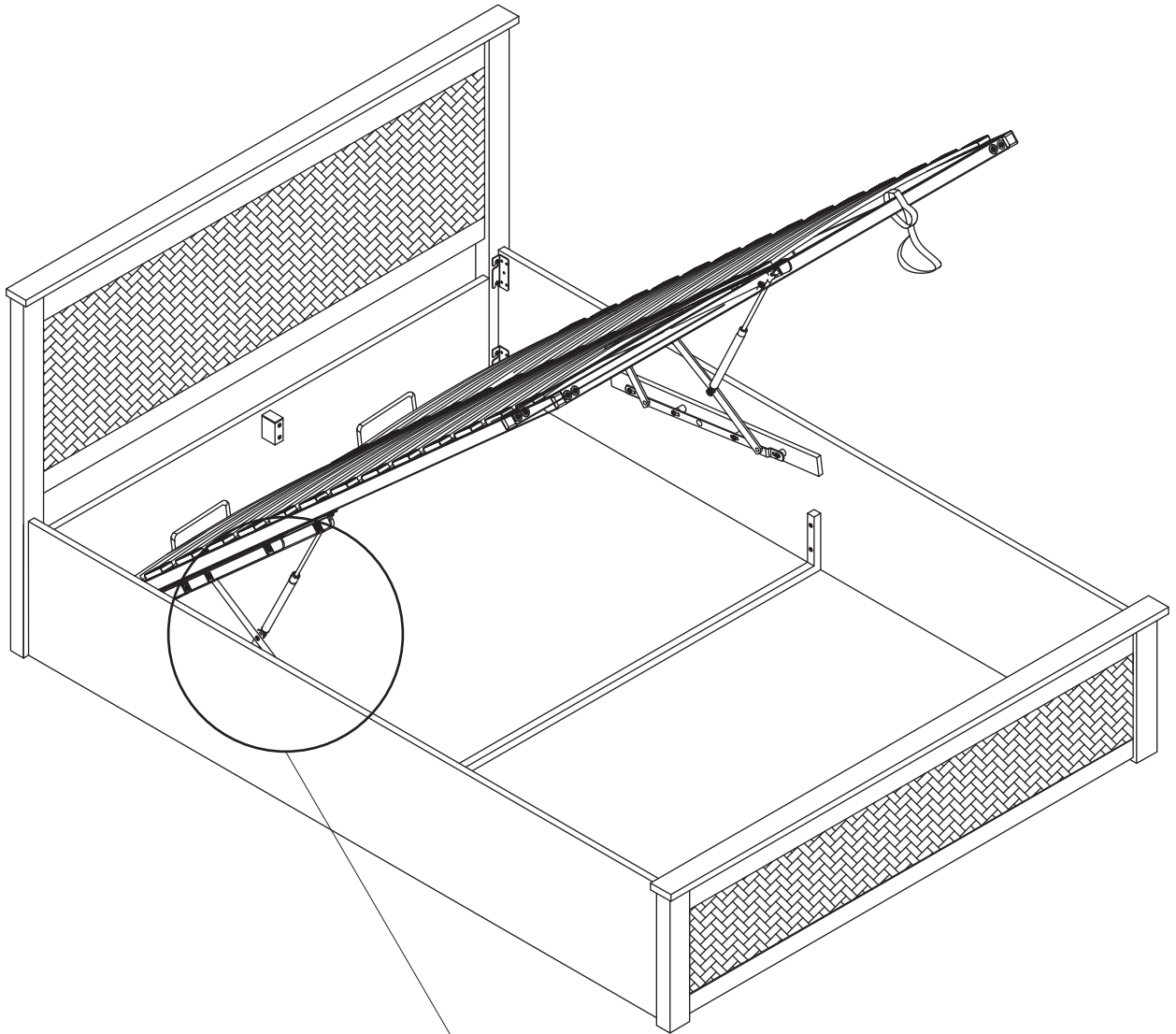
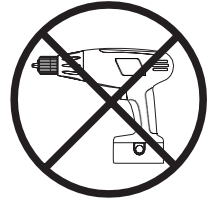

10 Pull the belt tight after loop-on

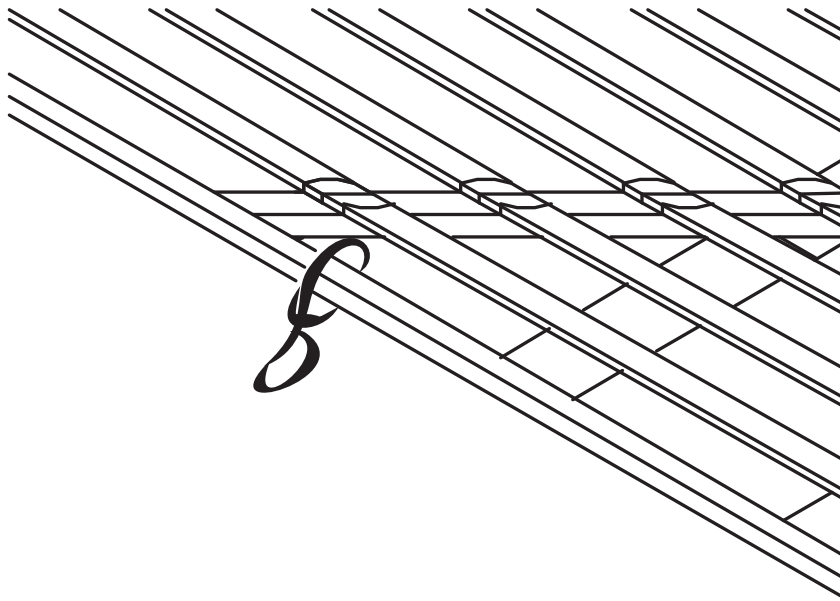
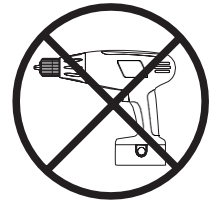

11 Place the mattress onto the frame(MATTRESS NOT INCLUDED)

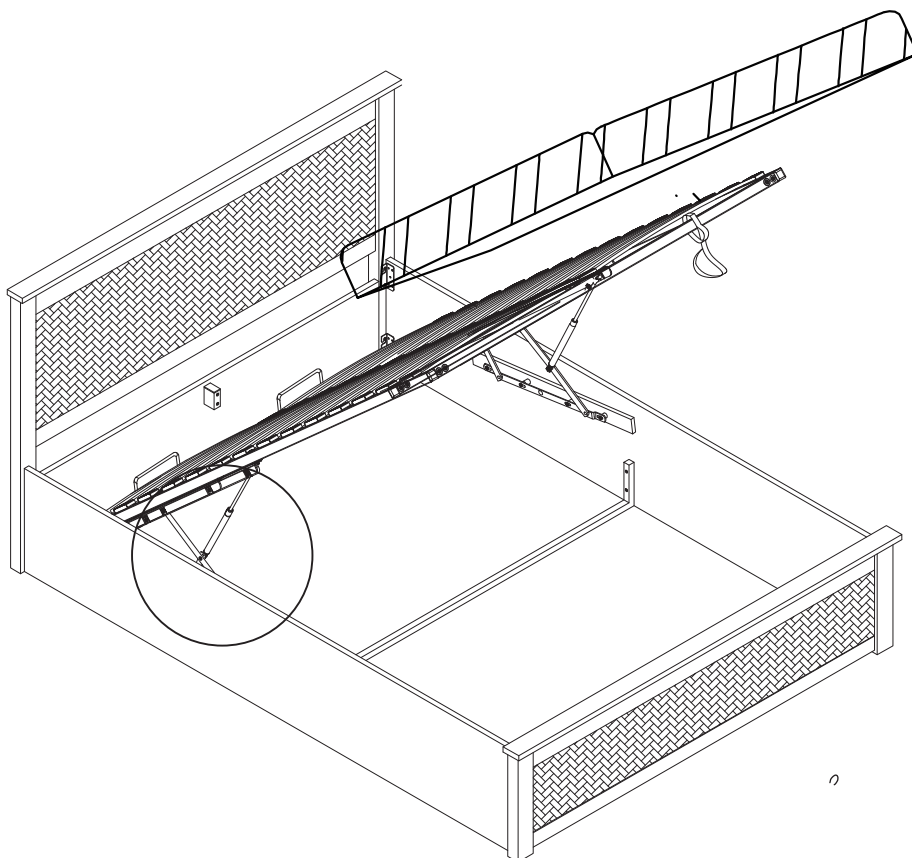

Notes:

It is imperative that the bed is aligned squarely to prevent the frame from catching on and damaging the side rails. Please use extra caution when opening and closing the bed, ensure a similar spacing on each side of the frame.

Hints and Tips

To operate the ottoman, always use 2 hands at arm's length and only where illustration on this product. You must ensure the mattress is on the bed frame before lifting the mechanism. **Failure to do so may result in injury.**

To ensure your safety please do not stand too close in case the frame bounces up. The weight of the mattress loaded on the frame will keep the frame in a lower position until it is pulled upwards by the user.



Do not attempt to move the bed whilst the frame is in the upright position

If removing the mattress, make sure the frame is secured so it does not flip open. When lifting the bed frame, remove pillows and covers.

PLEASE NOTE - It takes a lot of force to make the initial movement of the ottoman – **THIS IS A DESIGN FEATURE OF THE PRODUCT SO THAT IT DOES NOT FALL SHUT** - and the nearer to being closed the ottoman is, the easier it is to move. When the ottoman is almost shut, it will close completely under its own weight.

When lowering the slat unit for the first time, take care to make sure it does not rub unevenly on the inside face of the Side Rail. If it does, the bed has been assembled slightly out of square. This can be rectified by moving the Footboard of the bed slightly to the left or right whilst leaving the headboard of the bed frame stationary.

Tip for difficulty with compression:

If you are experiencing difficulty with the initial compression try fitting one piston at a time (following the Assembly Instructions) then press down on the side of the frame with the piston fitted - this acts like a big lever (The weight of the mattress can be used to supplement the load exerted). Effectively you are doubling the amount of force applied, because you have halved the resistance offered by the pistons. It can take slightly more effort than you might feel comfortable applying to the bed frame at first.

GENERAL CARE & MAINTENANCE

We advise that when cleaning the product that a damp cloth is used.

Avoid the use of all household cleaners and abrasive.

Never push or drag the furniture.

Never attempt to move the furniture when fully loaded.

We advise that periodically all fixing are re-tightened.