

## STEP 4

Connect the Arms (D) to the Sofa Bed by aligning the downward facing brackets with the upward facing brackets and push down firmly to connect.

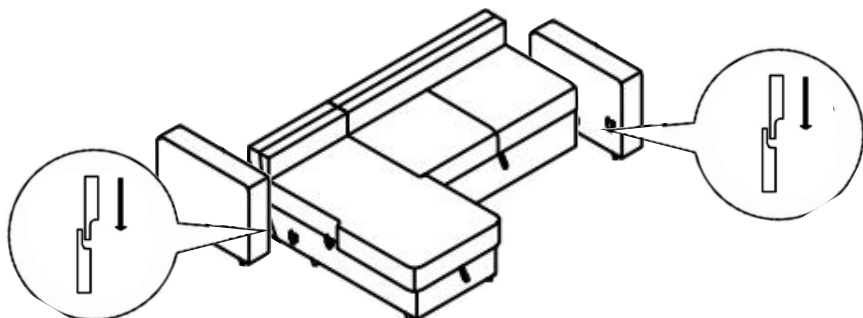

## STEP 5

After all pieces are assembled securely, place the Back Cushions (E) onto your sofa bed. Your sofa bed is now ready to use.

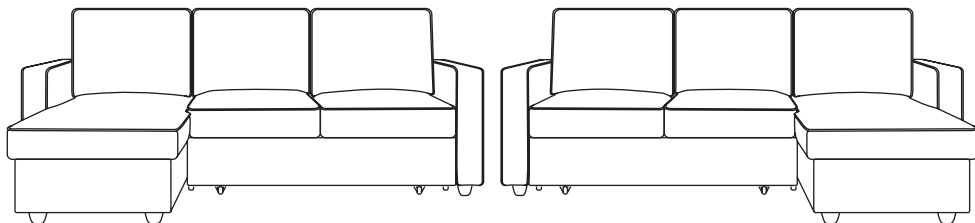

## USING YOUR SOFA BED

**FROM SOFA TO BED:** Carefully, pull the Pop Up Section out using the handle, then gripping the edge of the drawer to open it out fully. Use the handle to pull the Pop Up Section up and gently push it into place.

**FROM BED TO SOFA:** Use the handle to pull the Pop Up Section up and gently push it back down into the drawer, then tuck the drawer underneath the sofa.

To operate the storage section of the sofa bed, lift the chaise section upwards slowly, using one hand on either side to ensure a smooth motion.

FABRIC CONTENT  
MAIN FABRIC 100% POLYESTER  
OTHER FABRIC (VISIBLE)  
NON-WOVEN FABRIC 100% POLYESTER

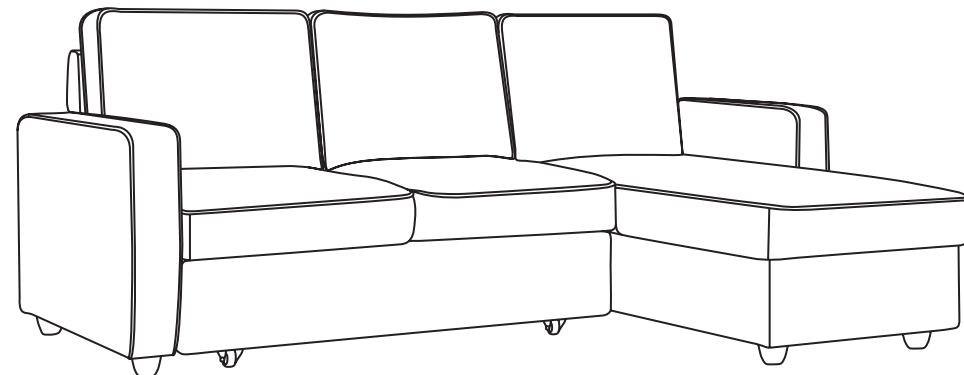

## KY088 CORNER SOFA BED

Thank you for your purchase. The following care instructions will allow you to make the most of your sofa bed; helping to prolong the look and life of it by preventing wear and damage.

### IMPORTANT INFORMATION

**PLEASE ENSURE YOU READ THIS LEAFLET BEFORE USING YOUR SOFA BED. DO NOT DISCARD OF ANY PACKAGING UNTIL YOU HAVE CHECKED THE PRODUCT THOROUGHLY.**

### CARING FOR YOUR SOFA BED

- Pre-brush fabric with a soft brush and then gently vacuum.
- Plump any accent/removable cushions regularly to prevent them becoming mis-shaped or flat.
- Use a microfibre cloth to remove dust from wooden surfaces.
- In the event of a spill or stain, use specialist upholstery cleaner or cleaning services.
- Avoid contact with sharp objects such as buckles, toys and jewellery as these can easily snag, tear and/or pull the fabric.







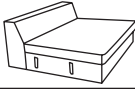
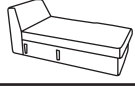
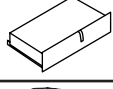

### SUNLIGHT AND HEAT DAMAGE

- Avoid contact with direct sunlight. If needed, move items or change their position to avoid the same area being exposed to repeated sunlight/heat.
- Do not place your sofa bed close to fire places and/or radiators.
- Hot objects such as mugs/plates can permanently mark the fabric and wood, avoid placing these on the sofa bed.

## SAFETY WARNINGS

- Do not allow children or pets to climb or jump on the sofa bed.
- Avoid the risk of entrapment by using the sofa bed as intended; sitting facing forward on the seat.
- Do not allow children to operate the sofa bed mechanism.
- Storage compartment is for storing items ONLY. Do not climb in or allow children to climb in.
- Keep small parts and plastic packaging away and out of reach of children and pets.

## PARTS LIST

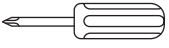
IMAGE	DESCRIPTION	PART NO.	QTY
	Seat Section	A	1
	Chaise Section	B	1
	Pop Up Section	C	1
	Arm	D	1
	Arm	E	1
	Back Cushion	F	3
	Main Leg	G	10
	Support Leg	H	4
	Castor	I	4
	Screw	J	16
	Screw Driver	K	1

## ASSEMBLY INSTRUCTIONS

Unpack your sofa bed and check that all the parts on the Parts List are present. If any are missing, please contact the retailer from whom you purchased the product.

We would advise having two people to assemble this product.

### STEP 1

Assemble your sofa bed on a flat and soft surface to prevent any damage. Attach the Main Legs (G) to the Chaise Section (B) and Arms (D,E), followed by the Support Legs (G) onto the Seat Section (A) and Castors (H) on to Pop Up Section (C).

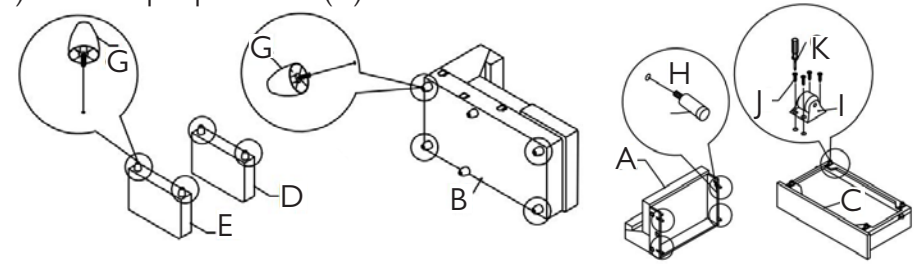

### STEP 2

Place the Seat Section (A) on its feet, then gently guide the Pop Up Section (C) on to its runners.

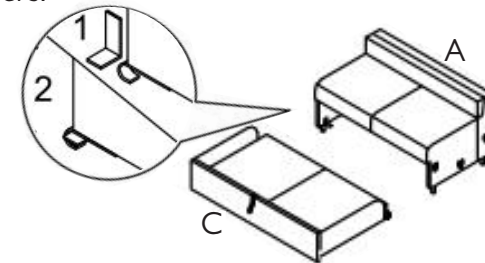

### STEP 3

Choose which side you would like your chaise on (left hand or right hand facing), align your brackets and push down firmly to connect the pieces.

