



# Birlea

Suppliers of inspiration

## Assembly Instructions

Thank you for  
purchasing a  
**Birlea** product.

For a chance to win a Love 2 Shop voucher simply post a picture of your new product on your preferred social channels tagging Birlea Furniture and using the hashtag **#ShareYourStyle** and **#Birlea**. One winner will be selected at random each month.

To view our full terms and conditions please visit [www.birlea.com](http://www.birlea.com)

### Are you happy with your purchase?

**Yes:** That's great, we would love to hear more from you. Please leave us a review on our social media channels or Trustpilot. Your feedback will be greatly appreciated.

**No:** If for any reason there is something missing, indifferent or incorrect with your order, please contact the retailer you purchased the item from. We will work with the retailer to resolve your issue as quickly as possible.



# Grande Bed - King

## Assembly Instructions

### Before you begin...

1. Please check you have received the correct product.
2. Unpack all boxes and lay out each component on the floor.
3. Check your product for any damage that may be immediately obvious. If damage is identified, please contact your retailer.
4. Please read through these instructions thoroughly to ensure you have constructed your bed correctly.

### For Care and Maintenance of your bed...

- Always assemble in your desired room of use.
- Always check all screws and fixings periodically to ensure they are still secure.
- Do not push or pull this bed as it will cause damage.
- Always lift this bed with a second person to prevent damage or injury.
- Keep any sharp objects away from this bed frame.

### For your Health and Safety...

- Please don't jump on this Bed.
- Do not use this bed if you find missing, damaged or worn parts. Please contact your retailer.
- Please do not use this bed until you have fully secured all fixings.
- Please keep all small components away from children.
- Please ensure this bed is on an even, level surface.

### Also...

If your desired room of choice has a non-carpeted surface please ensure that you use some form of protection and **do not** place directly on the wooden floor. This will prevent the bed from moving and therefore collapsing which will void your guarantee..

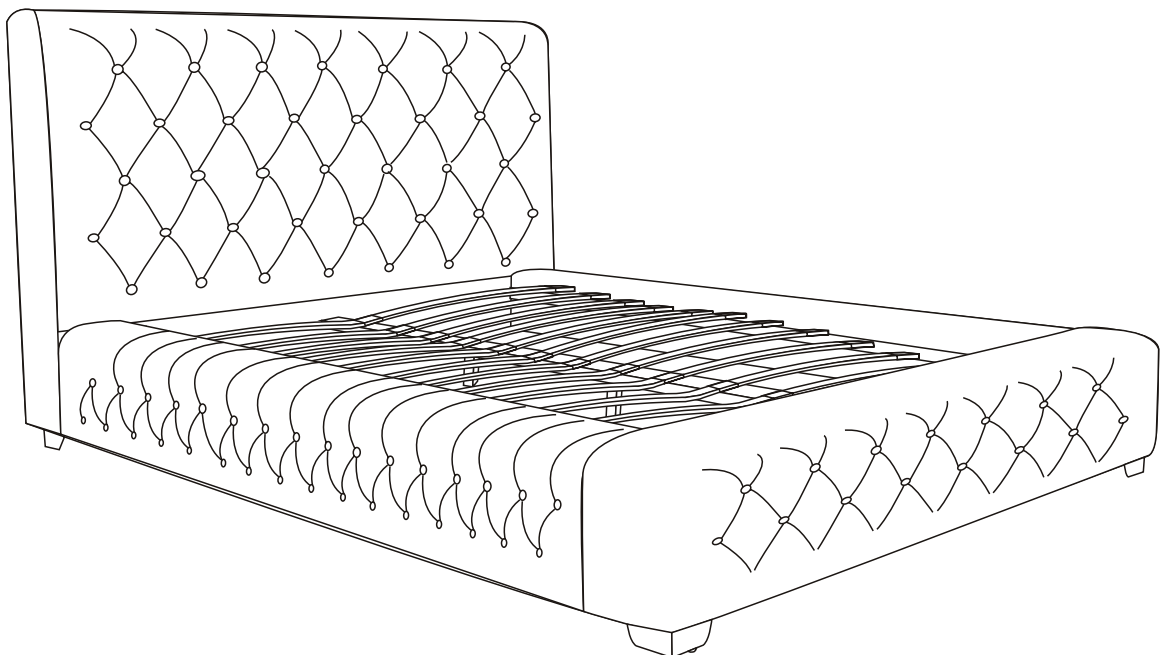

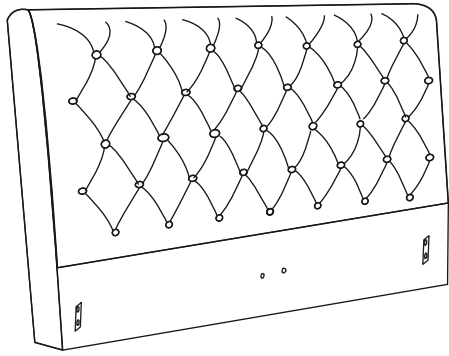
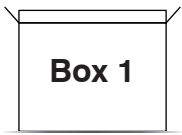

**A. Headboard (x1)**

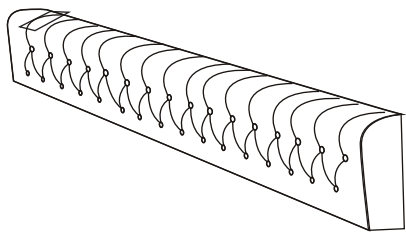
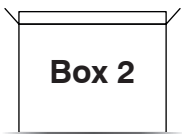

**B. Side Rails (x2)**

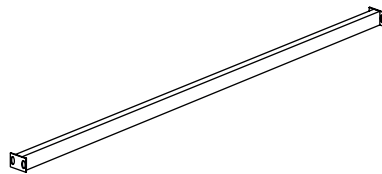

**C. Centre Support Rail (x1)**

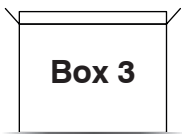

All fittings are stored within Box 3

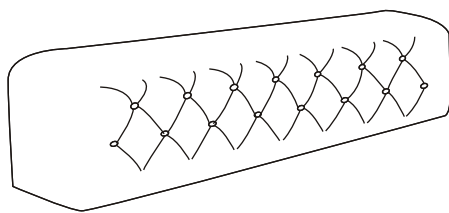

**D. Footboard (x1)**

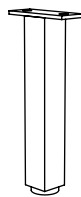

**E. Support Leg (x2)**

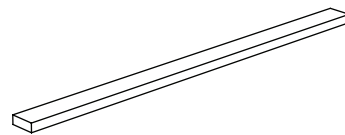

**F. Slats (x28)**

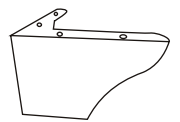

**G. Legs (x4)**

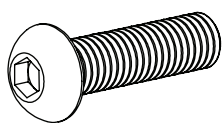

**H. M8x30mm Bolts (x12)**

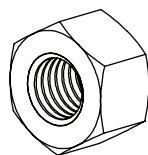

**I. Nuts (x4)**

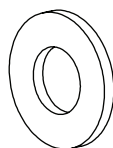

**J. Flat Washer (x8)**



**K. Spring Washer (x8)**

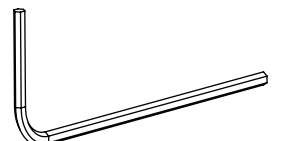

**L. M5 Allen Key (x1)**

**Box 3  
Cont...**

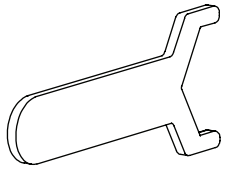

**M. Spanner (x1)**

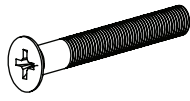

**N. Screw (x16)**

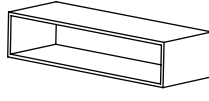

**O. Slat Caps (x28)**

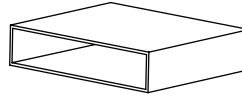

**P. Centre Slat Caps (x14)**

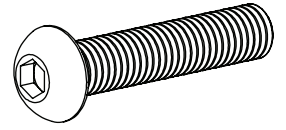

**Q. M8x40mm Bolts (x4)**

## Step 1

Unpack all components from the boxes and check you are not missing anything. Please check these against the list on page 3 and 4. Should you identify any missing components, please contact the retailer you purchased the bed from.

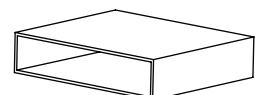
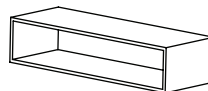
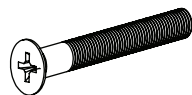
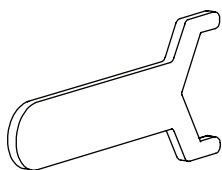
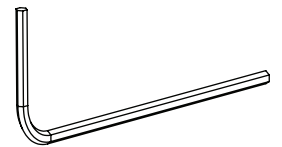
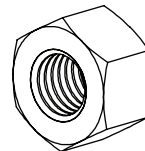
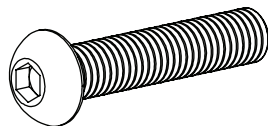
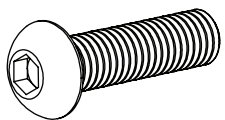
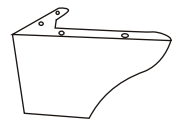
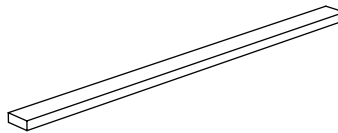
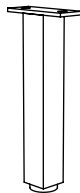
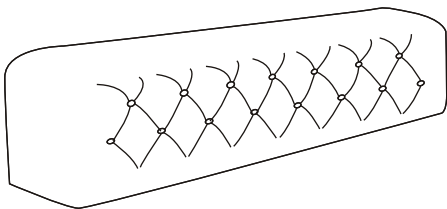
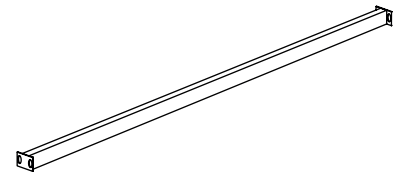
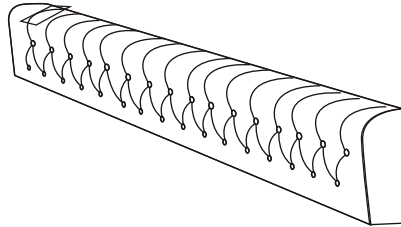
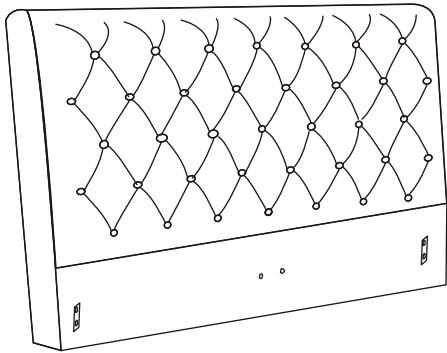

## Step 2

Attach 2x Legs (G) to the 1x Headboard (A) and then attach 2x Legs (G) to the 1x Footboard (D) using 16x Screw (N) and Screwdriver (Not Provided). Please do not use any power tools for this assembly as it will void your guarantee.

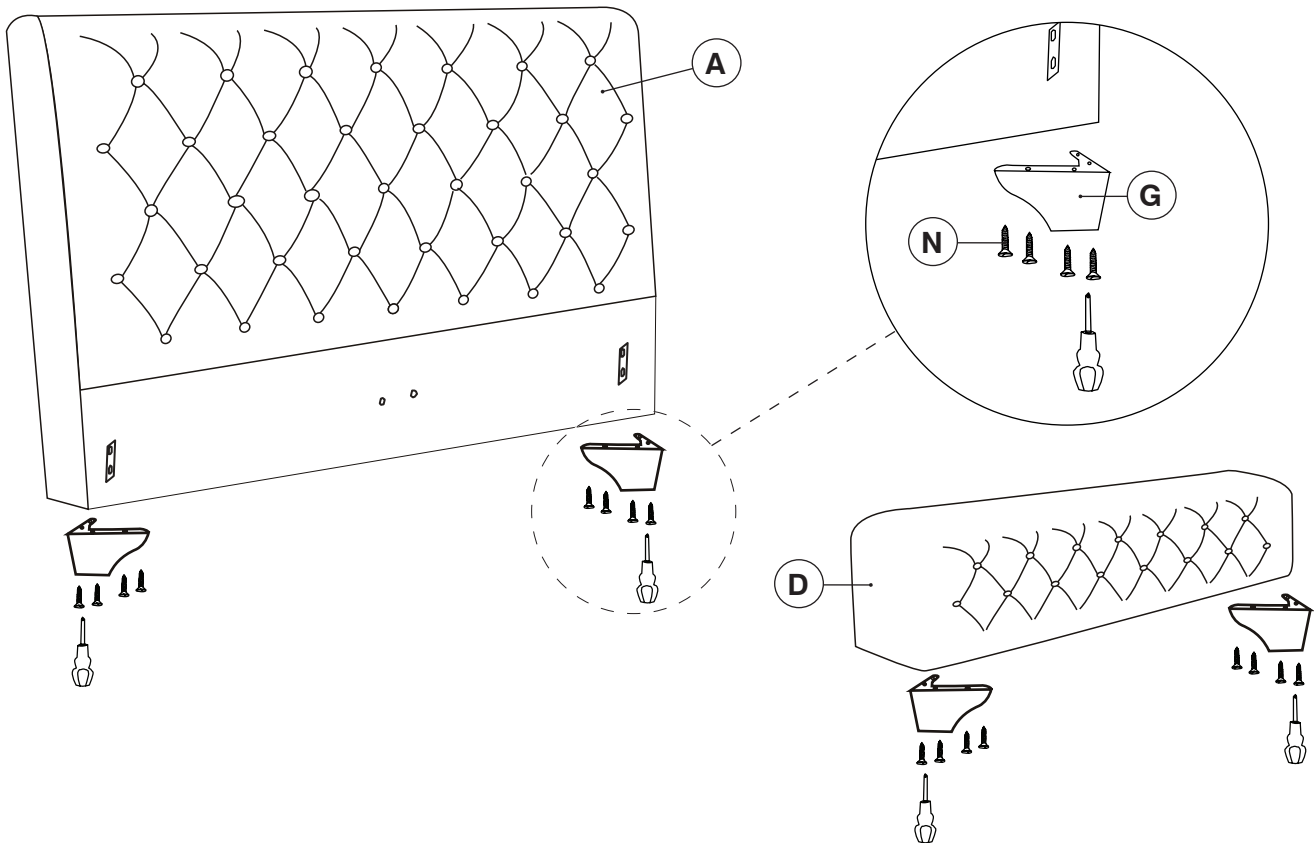

## Step 3

Next, attach 2x Support Leg (E) to 1x Centre Support Rail (C) using 4x M8x40mm Bolts (Q), Allen Key (L), 4x Nuts (I) and Spanner (M).

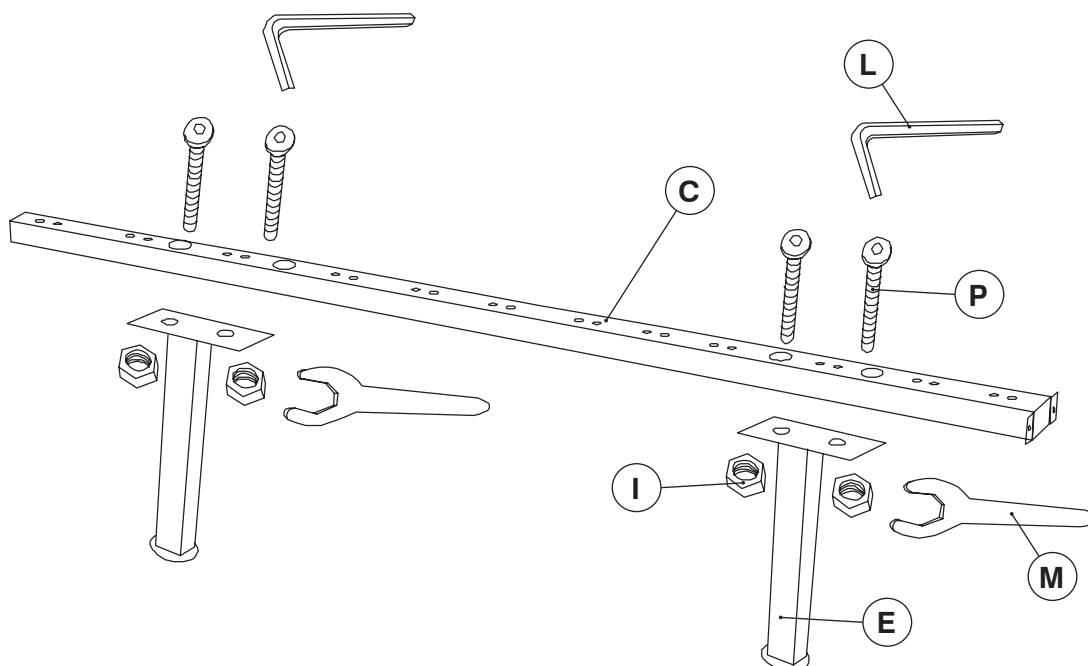

## Step 4

Attach 2x Side Rails (**B**) to 1x Headboard (**A**) and 1x Footboard (**D**) using 8x M8x30mm Bolt (**H**), 8x Spring Washer (**K**), 8x Flat Washer (**J**) and 1x M5 Allen Key (**L**). Then attach 1x Centre Support Rail (**C**) to 1x Headboard (**A**) and 1x Footboard (**D**) using 4x M8x30mm Bolt (**H**) and 1x M5 Allen Key (**L**).

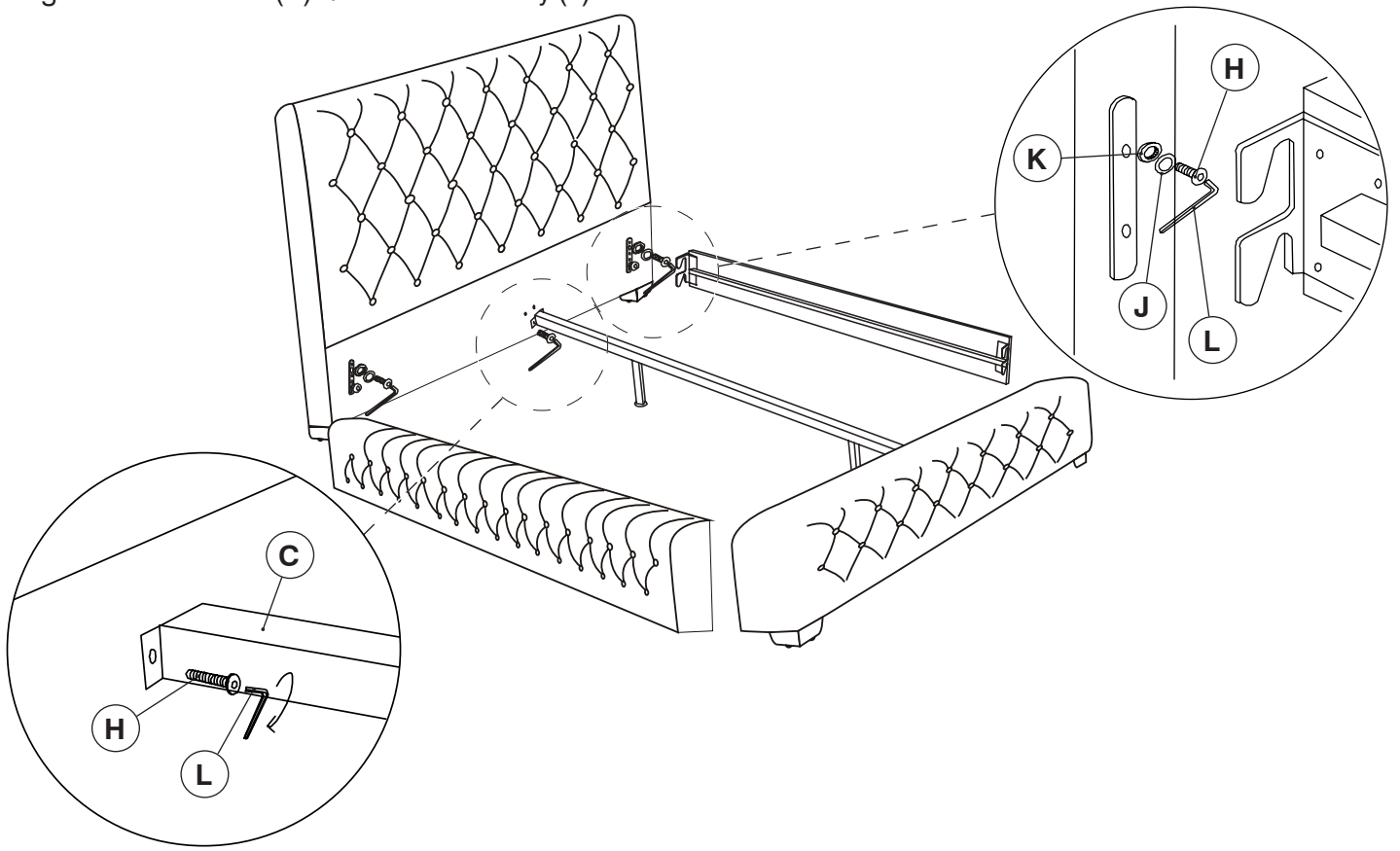

## Step 5

Slot each Slat Cap (**O**) on to the end of each Slat (**F**). Then slot each Slat (**F**) into each Centre Slat Cap (**P**) Press firmly into each Slat Rail located on the inside of Side Rail (**SR**) and then into the Centre Support Rail (**C**).

