

# WHITE / OAK EFFECT PORTLAND 2 DOOR WARDROBE ASSEMBLY INSTRUCTIONS

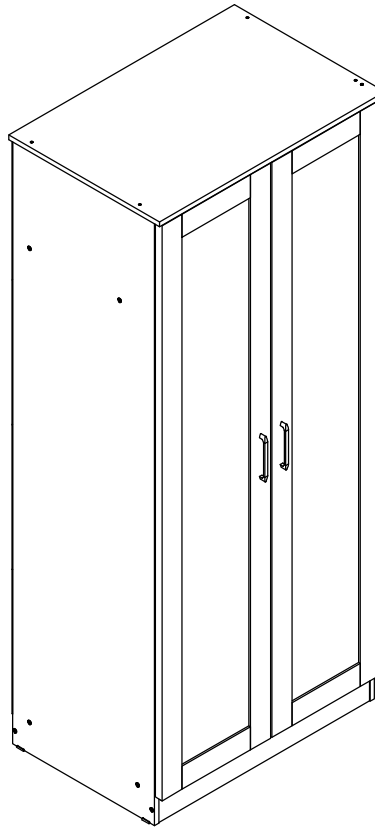
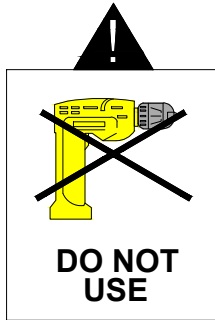

## **IMPORTANT FOR DOMESTIC USE ONLY PLEASE READ BEFORE YOU CONTINUE FURTHER**

THE PRODUCT YOU HAVE PURCHASED WILL GIVE YOU MANY YEARS OF SERVICE IF YOU FOLLOW THE GUIDELINES FOR ITS SAFE ASSEMBLY AND PERIODIC MAINTENANCE AND CLEANING.

ASSEMBLE ON A SOFT CLEAN SURFACE.

DO NOT USE ANY TOOLS OTHER THAN THOSE SHOWN.

ANY SPANNERS OR ALLEN KEYS REQUIRED ARE INCLUDED WITH THE FITTINGS KIT.

DO NOT FOR ANY REASON USE A POWER TOOL TO ASSEMBLE THIS PRODUCT. ITS USE WILL INVALIDATE ANY CLAIM YOU MAY HAVE AND COULD MAKE THIS PRODUCT UNSAFE.

DEPENDING ON THE AMOUNT OF USE THIS PRODUCT RECEIVES IT MAY BE NECESSARY TO TIGHTEN UP THE FIXINGS FROM TIME TO TIME. THIS IS COMPLETELY NORMAL FOR ANY FLAT PACK FURNITURE. DO NOT OVERTIGHTEN FIXING.

FOR CLEANING, YOU MAY USE A DAMP CLOTH (NOT WET) DO NOT USE POLISH, DETERGENT OR CHEMICAL CLEANERS.



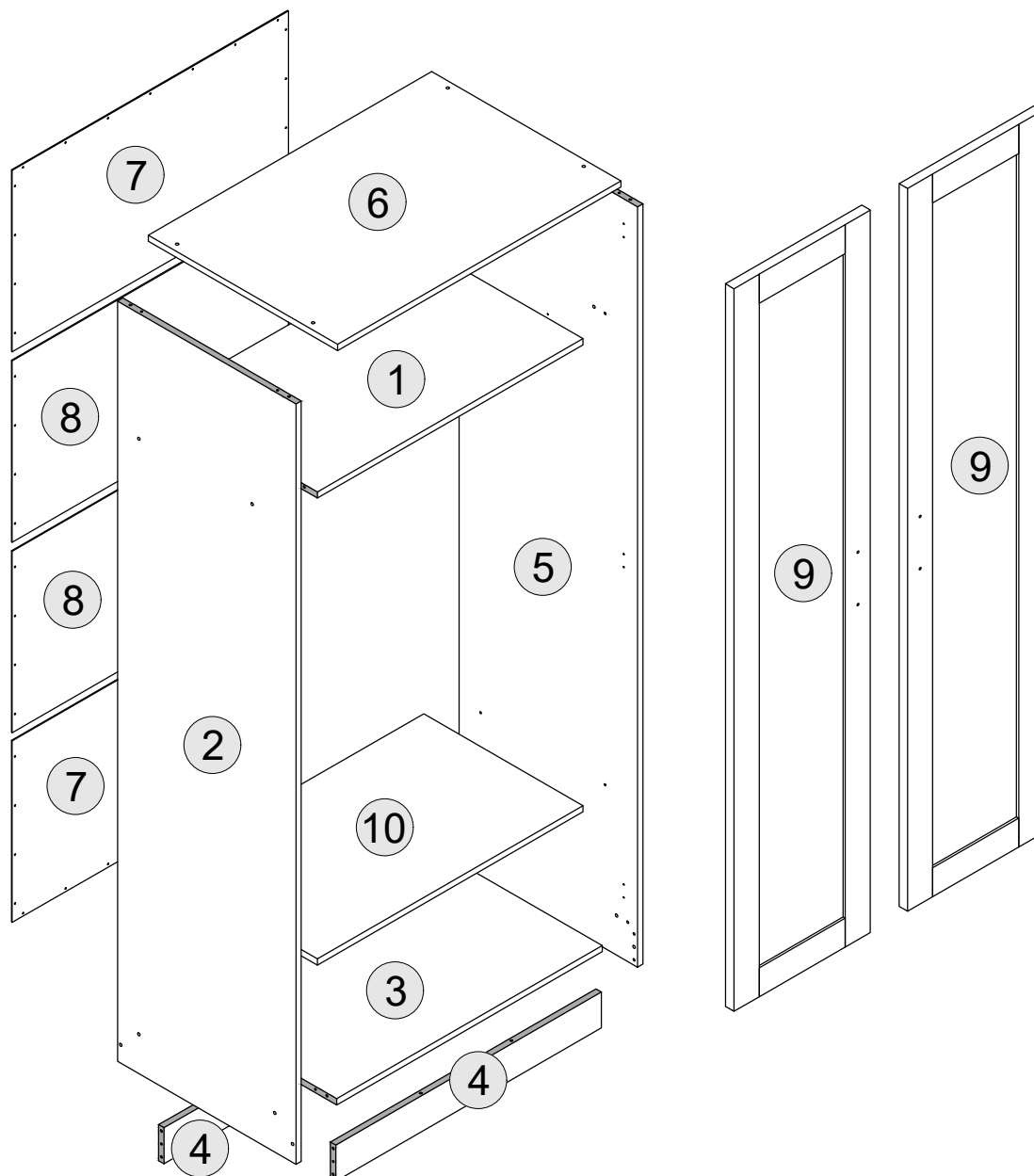









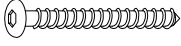
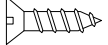
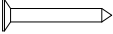



THE SURFACE OF THIS ITEM IS NOT HEAT RESISTANT. ALWAYS USE A PLACE MAT UNDER HOT OR COLD ITEMS TO PREVENT MARKING.

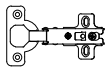

## PART LIST

<u>Part Number</u>	<u>Part Code</u>	<u>Part Description</u>	<u>Quantity</u>	<u>Carton</u>
1	S100-101-202-EU1-01	Top Shelf Panel	1	1/2
2	S100-101-202-EU1-02	Side Panel - Left	1	1/2
3	S100-101-202-EU1-03	Bottom Panel	1	2/2
4	S100-101-202-EU1-04	Base Apron	2	2/2
5	S100-101-202-EU1-05	Side Panel - Right	1	1/2
6	S100-101-202-EU1-06	Top Panel	1	2/2
7	S100-101-202-EU1-07	Back Panel I	2	2/2
8	S100-101-202-EU1-08	Back Panel II	2	2/2
9	S100-101-202-EU1-09	Doors	2	2/2
10	S100-101-195-EU1-10	Bottom Shelf Panel	1	1/2

## HARDWARE LIST

A		DOWEL 6 X 30MM	24 PCS
B		ALLEN KEY	1 PC
C		BOLT M6 X 50MM	12 PCS
D		SCREW M3.5 X 16MM	17 PCS
E		TACK	46 PCS
F		PLASTIC FOOT	4 PCS
G		SCREW M3.5 X 12MM	4 PCS
H		TAPPING SCREW M8 X 12MM	12 PCS
I		HANGING RAIL SUPPORT	2 PCS
J		HANGING RAIL	1 PC
K		SCREW M6 X 50MM	4 PCS
L		PLASTIC H STRIP	3 PCS
M		PVC STOPPER	1 PC
N		HINGES 5/8	6 PCS
O		HANDLE	2 PCS
P		SHELF SUPPORT	4 PCS
Q		HANDLE SCREW 22MM	4 PCS
R		ANTI - TIP STRAP	2 PCS
S		SCREW M4 X 16MM	2 PCS

# STEP 1

**PARTS REQUIRED**

1 - TOP SHELF PANEL x1

4 - BASE APRON x2

**HARDWARE REQUIRED**

A  16

**TOOLS REQUIRED**

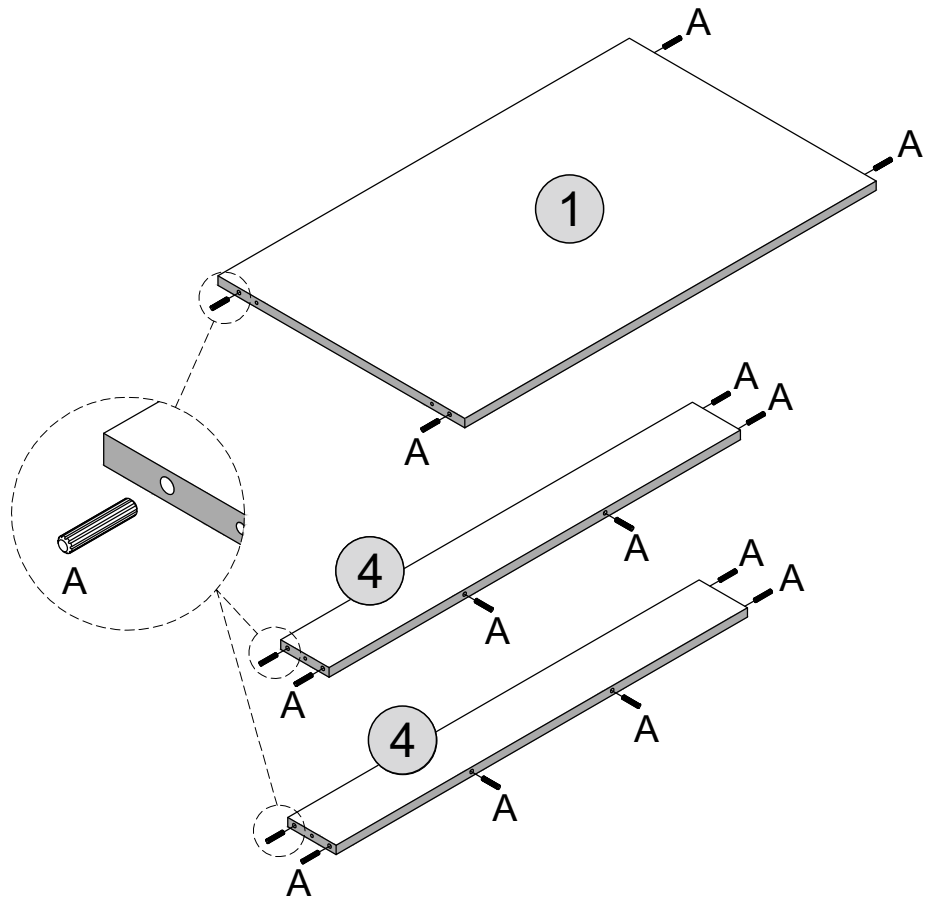
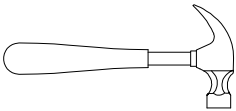

# STEP 2

**PARTS REQUIRED**

3 - BOTTOM PANEL x1

6 - TOP PANEL x1

**HARDWARE REQUIRED**

A  04

D  01

M  01

**TOOLS REQUIRED**

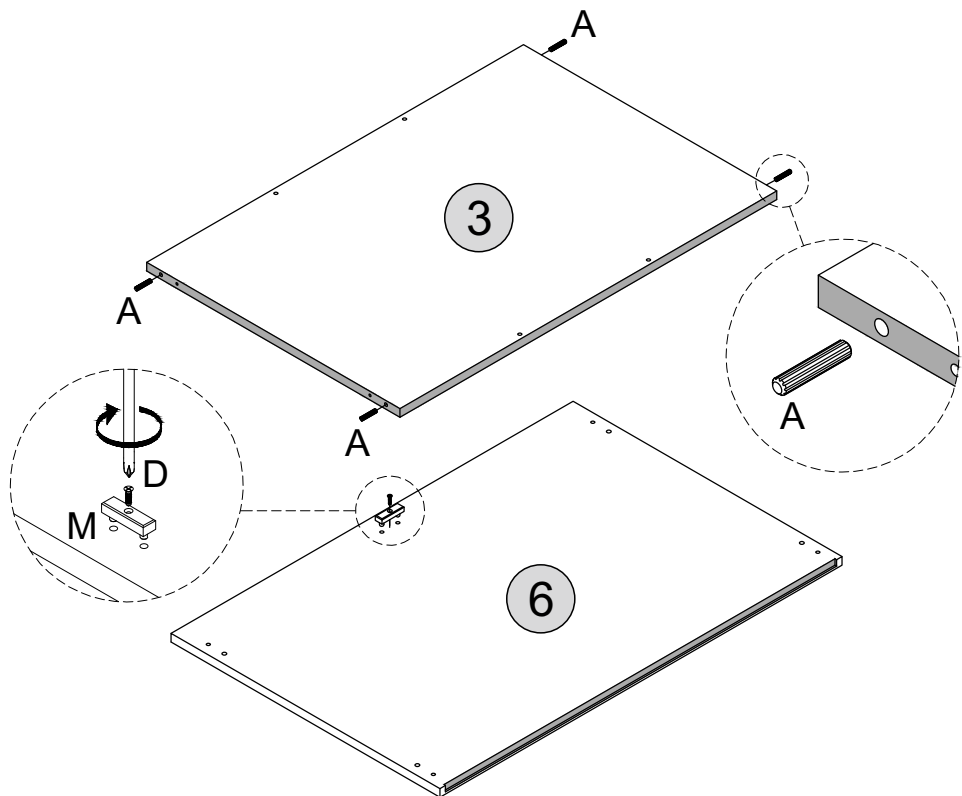
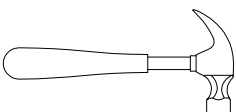
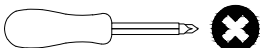

# STEP 3

**PARTS REQUIRED**

2 - SIDE PANEL - LEFT x1

5 - SIDE PANEL - RIGHT x1

**HARDWARE REQUIRED**

A  04

G  04

I  02

P  04

**TOOLS REQUIRED**

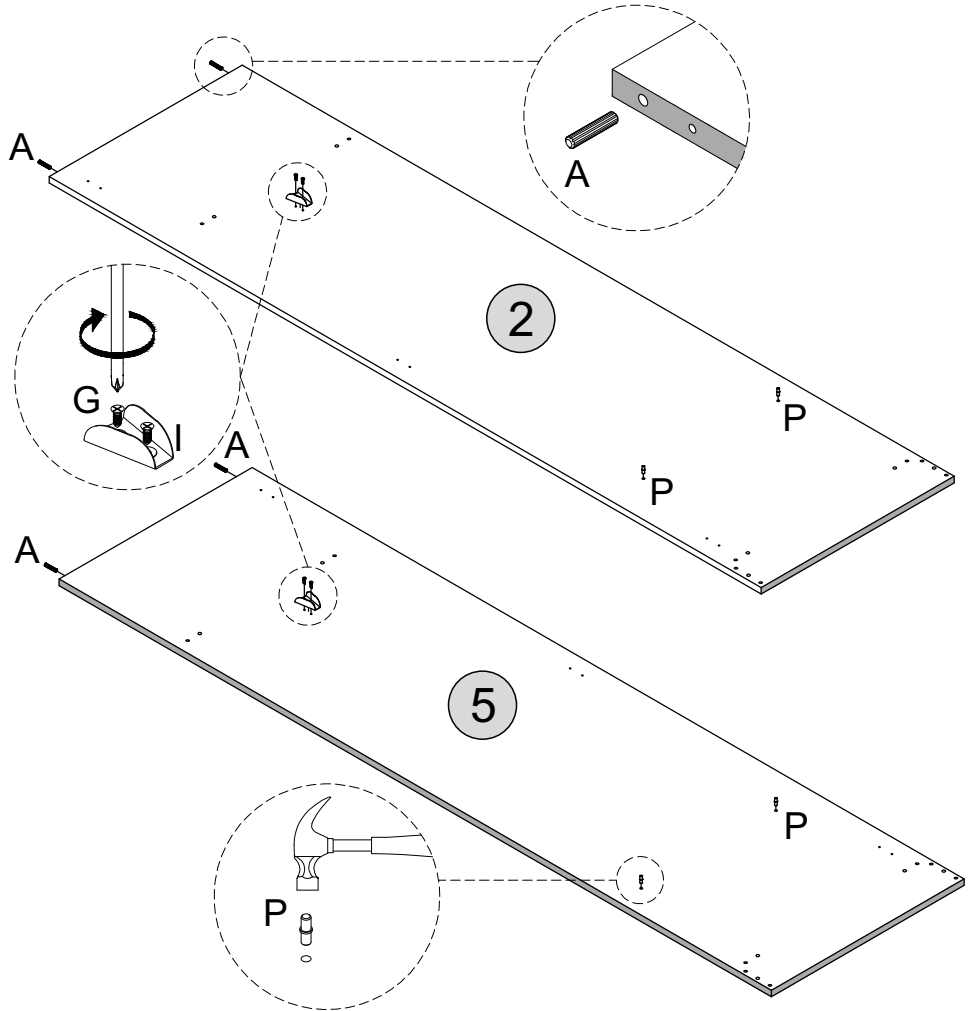
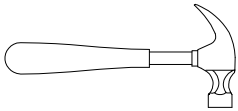
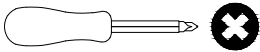

# STEP 4

**PARTS REQUIRED**

1 - TOP SHELF PANEL x1

2 - SIDE PANEL - LEFT x1

**HARDWARE REQUIRED**

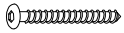
C  02

**TOOLS REQUIRED**

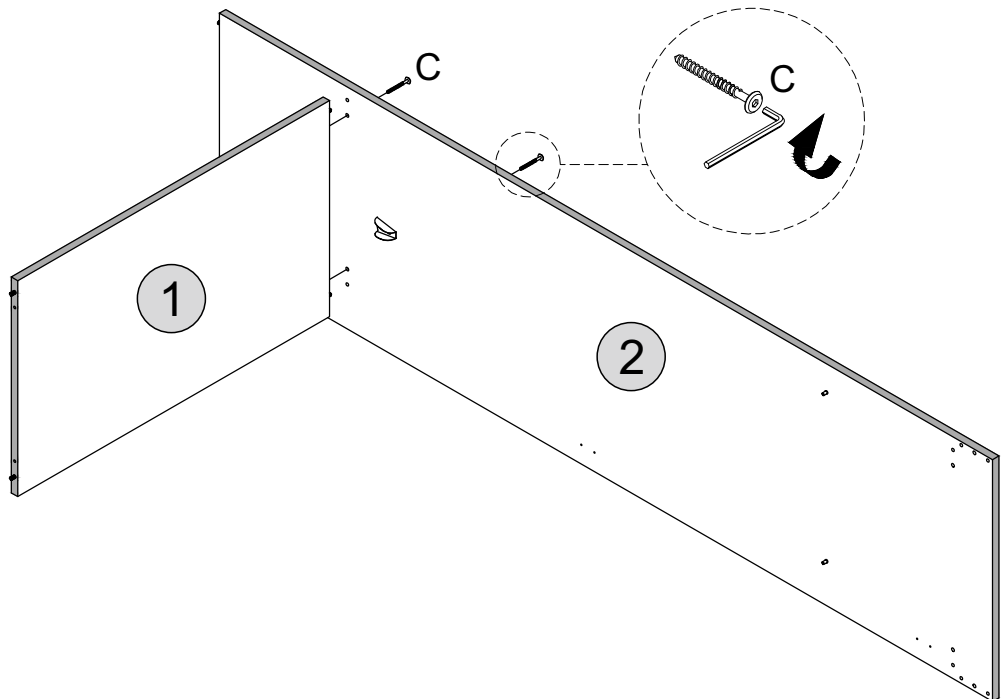
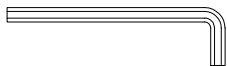

# STEP 5

PARTS REQUIRED

3 - BOTTOM PANEL x1

4 - BASE APRON x2

HARDWARE REQUIRED

TOOLS REQUIRED

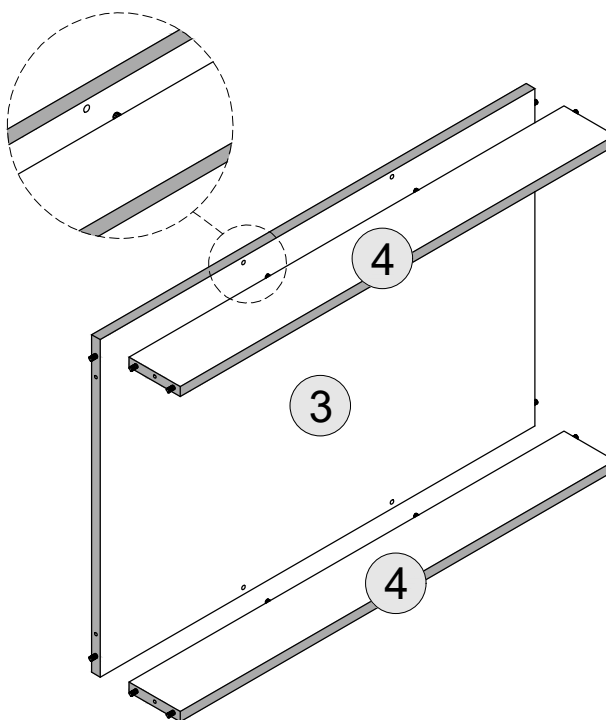

# STEP 6

PARTS REQUIRED

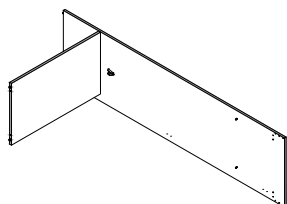

HARDWARE REQUIRED

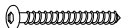
C  04

TOOLS REQUIRED

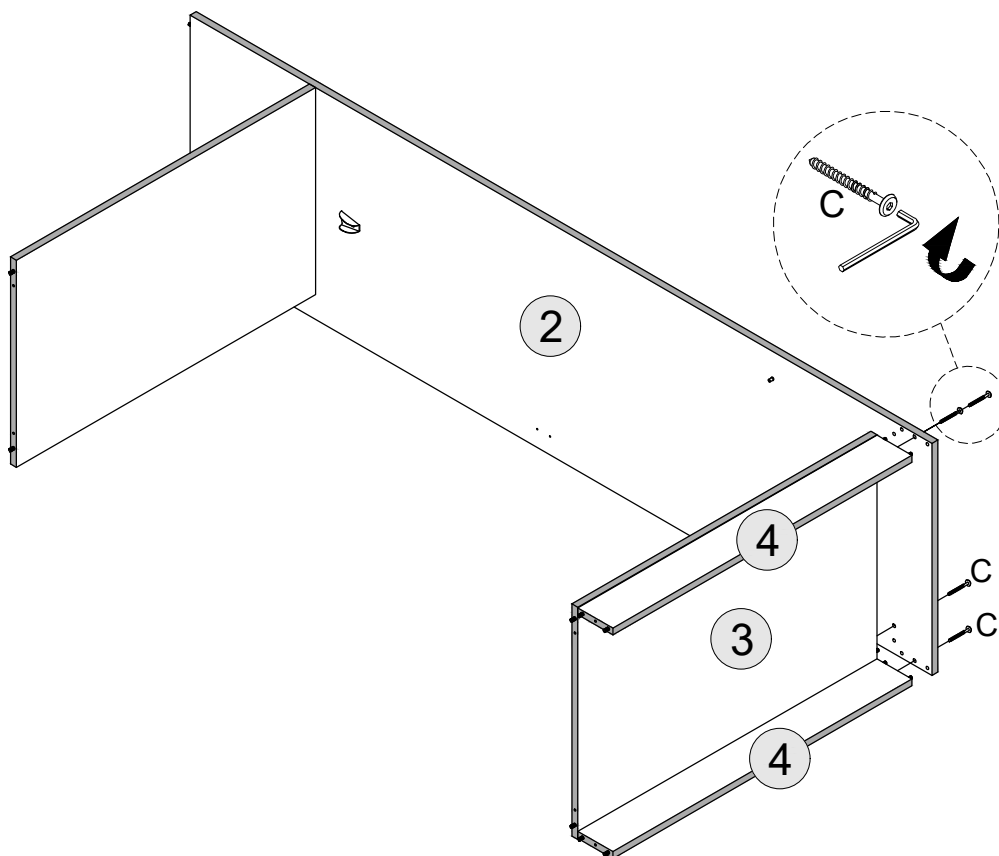

# STEP 7

**PARTS REQUIRED**

5 - SIDE PANEL - RIGHT x1

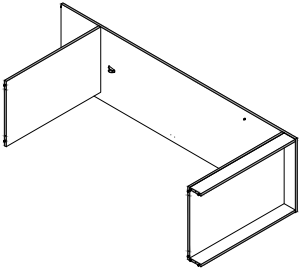

**HARDWARE REQUIRED**

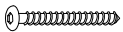
C  06

**TOOLS REQUIRED**

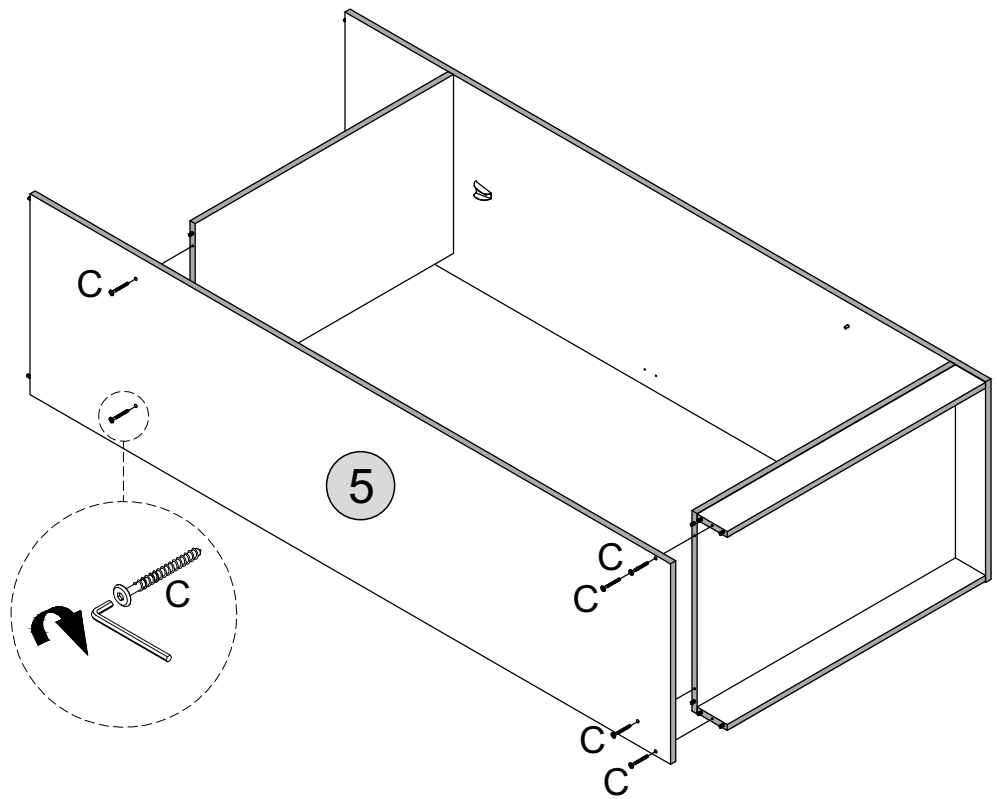

# STEP 8

**PARTS REQUIRED**

6 - TOP PANEL x1

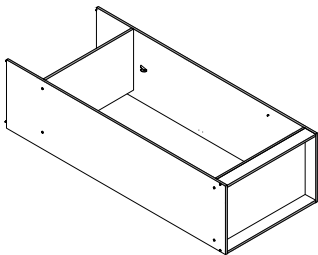

**HARDWARE REQUIRED**

D  04

F  04

K  04

**TOOLS REQUIRED**

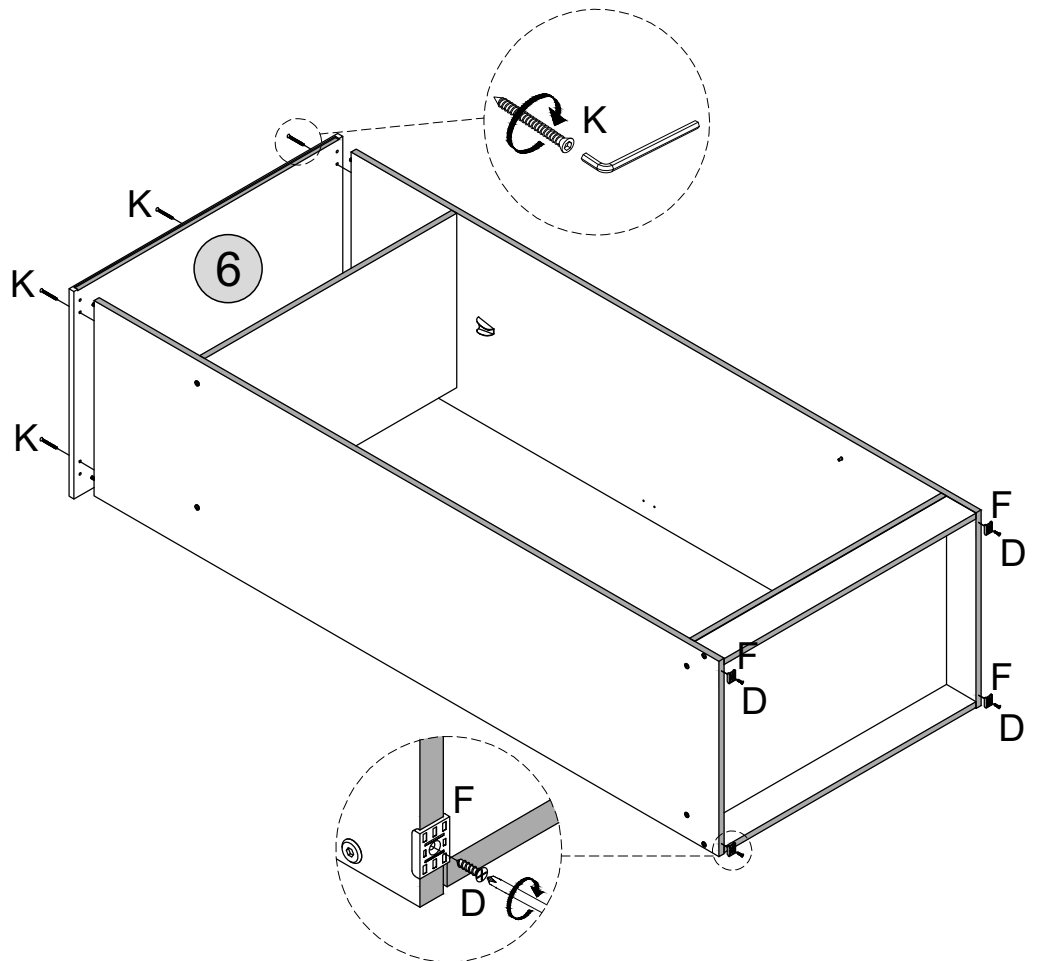
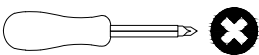

# STEP 9

**PARTS REQUIRED**

7 - BACK PANEL I	x2
8 - BACK PANEL II	x2

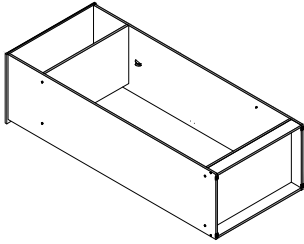

**HARDWARE REQUIRED**

E		46
L		03

**TOOLS REQUIRED**

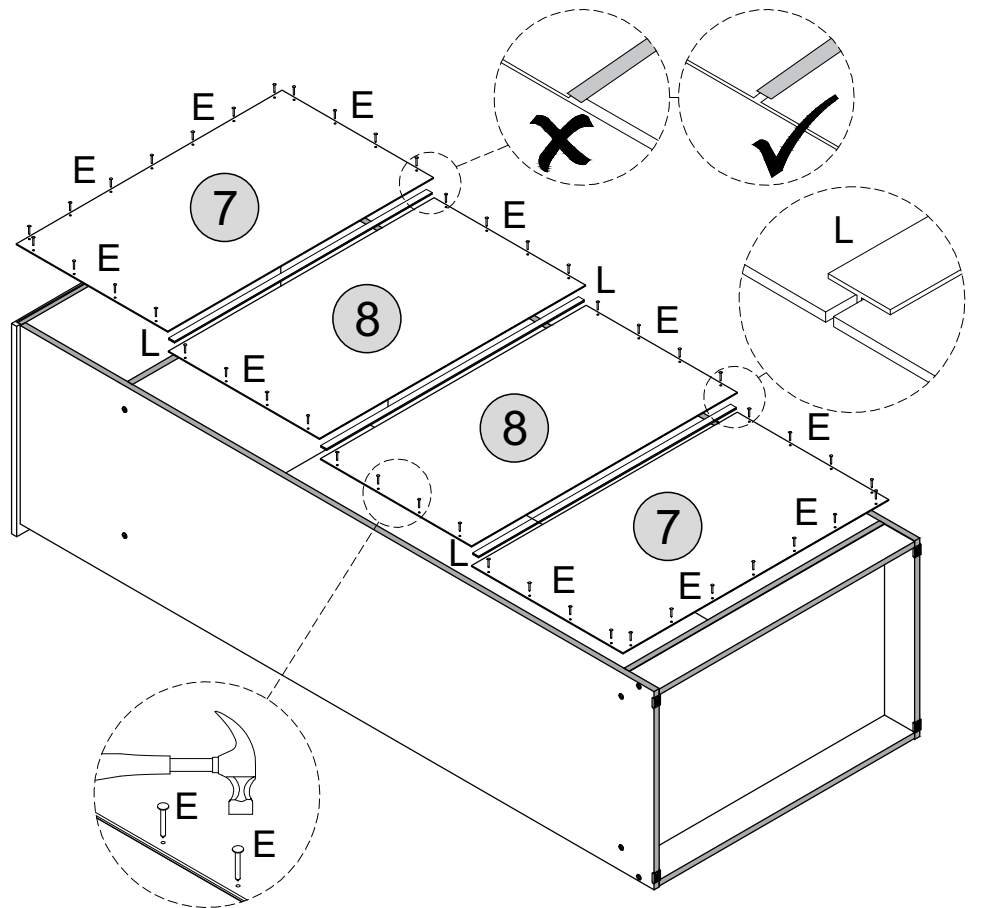
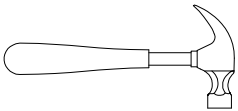

# STEP 10

**PARTS REQUIRED**

9 - DOORS	x2
-----------	----

**HARDWARE REQUIRED**

D		12
N		06

**TOOLS REQUIRED**

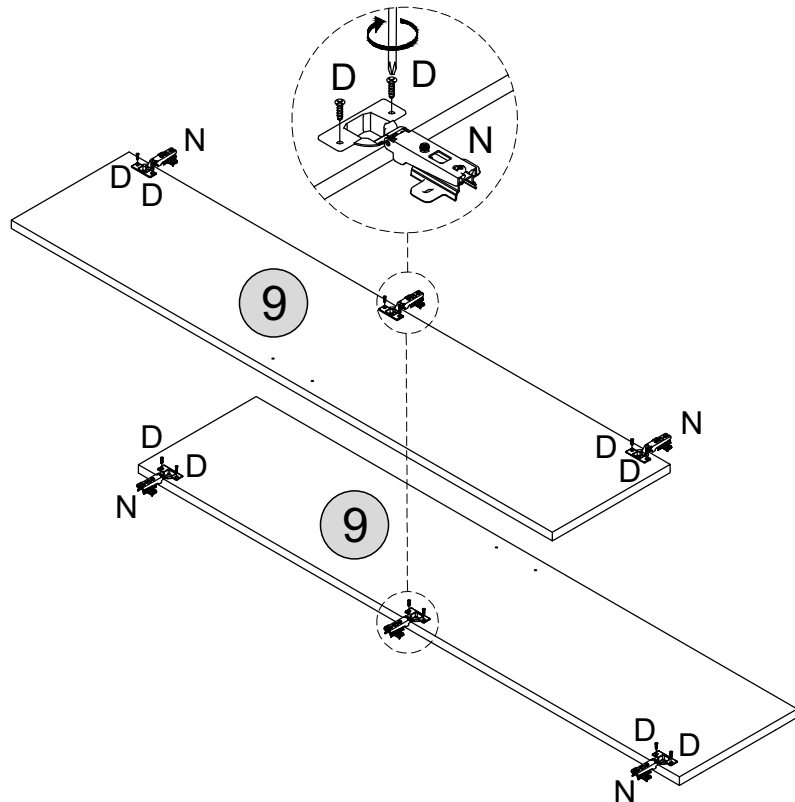
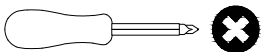





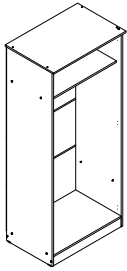

# STEP 11

**PARTS REQUIRED**

- 9 - DOORS x2
- 10 - BOTTOM SHELF PANEL x1



**HARDWARE REQUIRED**

- H  12
- J  01
- O  02
- Q  04

**TOOLS REQUIRED**

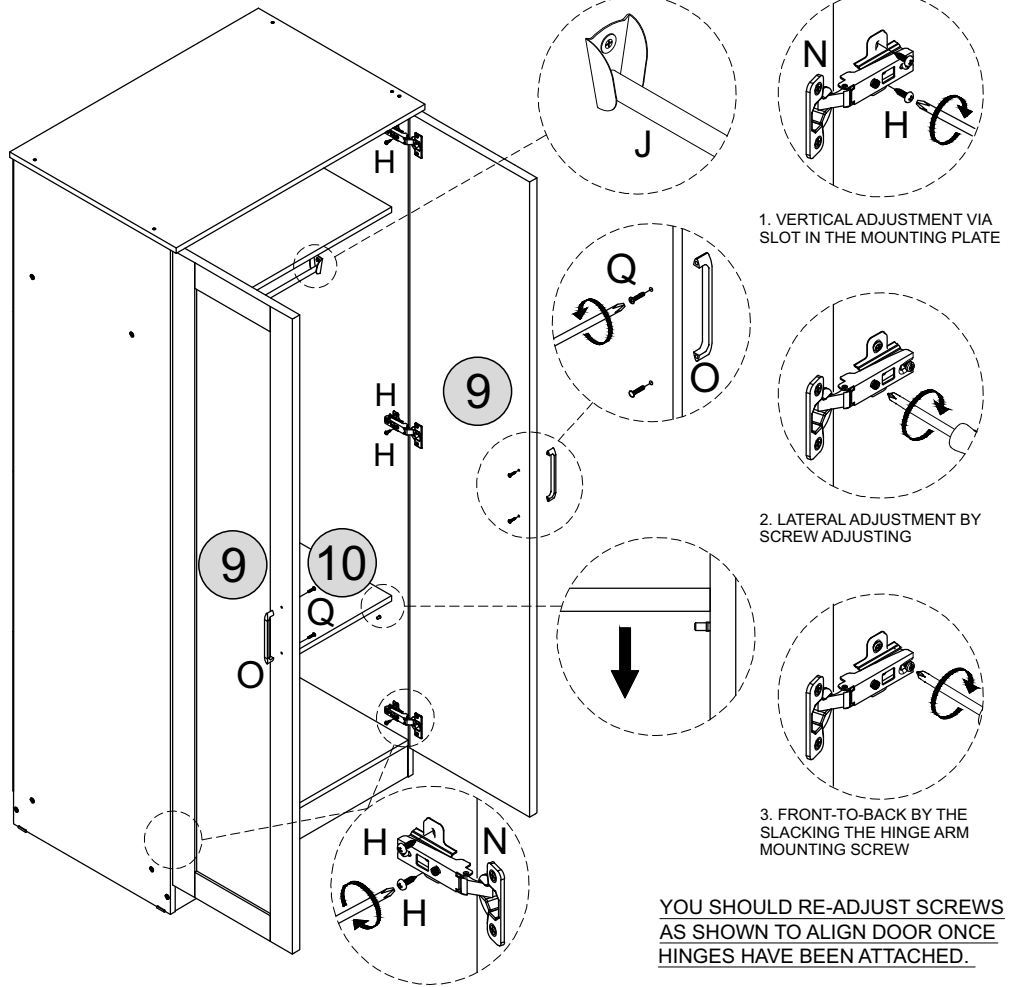
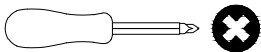

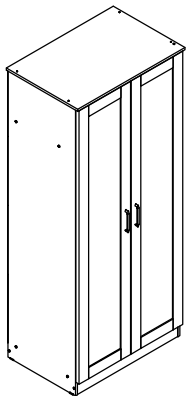

# STEP 12

**PARTS REQUIRED**



**HARDWARE REQUIRED**

- R  02
- S  02

**TOOLS REQUIRED**

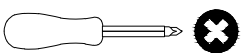

## WARNING

Serious or fatal injuries can occur from furniture tipping over. To prevent the furniture from tipping over we recommend that it is permanently fixed to the wall.

Wall fixings are not supplied with this product as different wall materials require different types of fixing devices. Please make sure you use fixings suitable for the walls in your home.

