

# CLEVELAND 3 + 2 DRAWER CHEST

## ASSEMBLY INSTRUCTIONS

### WHITE/GREY METAL EFFECT



### **IMPORTANT**

### **FOR DOMESTIC USE ONLY**

**PLEASE READ BEFORE YOU CONTINUE FURTHER**

## **CARE AND MAINTENANCE**

- After unpacking this product please keep the original packaging in case it needs to be returned for any reason.
- Please ensure all fittings and parts are present before commencing with assembly.
  - Never drag or push products as this could cause damage to the joints making it inferior.
  - We strongly recommend that you keep children away from your work area.
  - We recommend that you lay a blanket or sheet on the floor to avoid damage to both your floor and the product.
  - Assemble this product as close to its final position as possible.
  - Do not place this product next to a radiator or in direct sunlight.
  - Do not drag or push items across your high gloss furniture as this may cause the surface to scratch
  - Wood is a natural product and may expand if subjected to damp and may shrink or crack if subjected to heat. Therefore it is recommended that room temperature is maintained, with no sudden temperature fluctuations.
  - Make sure any spillage is wiped off immediately.
  - Do not place hot or chilled items directly on to the surface, use a place mat or marking will occur.
  - For general cleaning use a soft cotton or micro fibre cloth, and do not use detergents of any kind.
  - From time to time it may be necessary to tighten fittings, regular inspections should be carried out.
  - Do not place on a wet or damp floor as staining may occur to your floor.

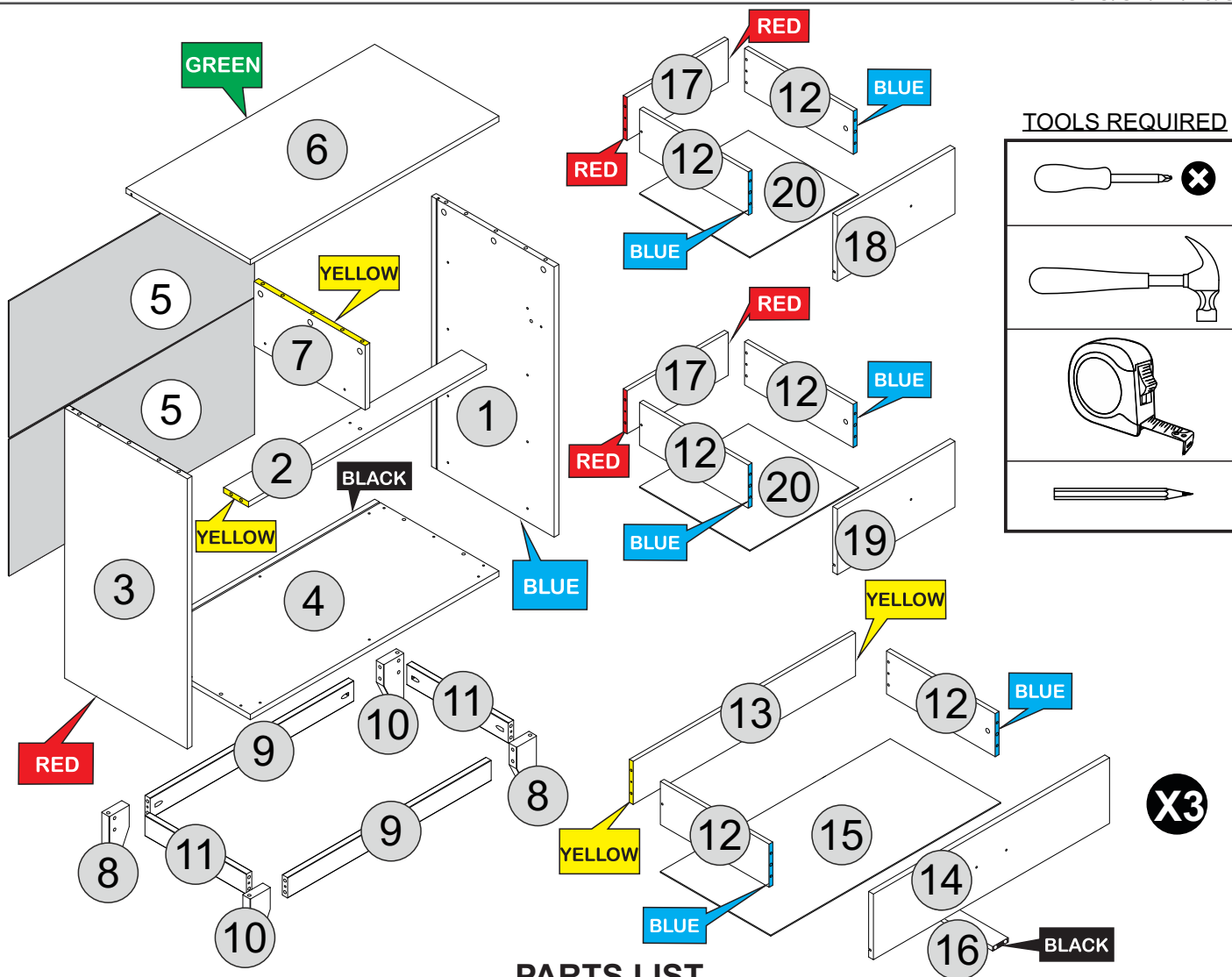









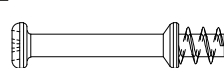
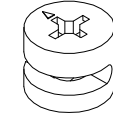
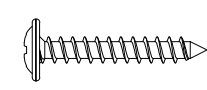

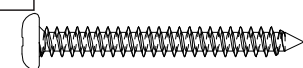
**PARTS LIST**

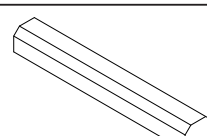
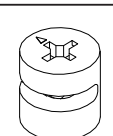
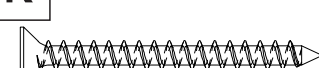
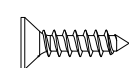
**Please Note:**  
The below parts have all been stamped with the part number/color to help identify them during assembly.

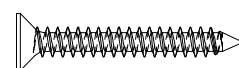
Part Number	Part Code	Part Description	Quantity	Carton
1	S100-102-190-SP1-01	Right Side Panel - <b>BLUE</b>	1	1/1
2	S100-102-190-SP1-02	Crossbar - <b>YELLOW</b>	1	1/1
3	S100-102-190-SP1-03	Left Side Panel - <b>RED</b>	1	1/1
4	S100-102-190-SP1-04	Base Panel - <b>BLACK</b>	1	1/1
5	S100-102-190-SP1-05	Back Panel	2	1/1
6	S100-102-190-SP1-06	Top Panel - <b>GREEN</b>	1	1/1
7	S100-102-190-SP1-07	Division - <b>YELLOW</b>	1	1/1
8	S100-102-190-SP1-08	Right Leg	2	1/1
9	S100-102-190-SP1-09	Leg Support Front & Back	2	1/1
10	S100-102-190-SP1-10	Left Leg	2	1/1
11	S100-102-190-SP1-11	Leg Support Left & Right	2	1/1
12	S100-102-190-SP1-12	Drawer Sides - <b>BLUE</b>	10	1/1
13	S100-102-190-SP1-13	Large Drawer Back - <b>YELLOW</b>	3	1/1
14	S100-102-190-SP1-14	Large Drawer Front	3	1/1
15	S100-102-190-SP1-15	Large Drawer Base	3	1/1
16	S100-102-190-SP1-16	Drawer Base Support - <b>BLACK</b>	3	1/1
17	S100-102-190-SP1-17	Small Drawer Back - <b>RED</b>	2	1/1
18	S100-102-190-SP1-18	Left Small Drawer Front	1	1/1
19	S100-102-190-SP1-19	Right Small Drawer Front	1	1/1
20	S100-102-190-SP1-20	Small Drawer Base	2	1/1

## FITTINGS LIST

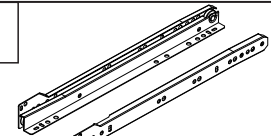
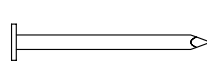
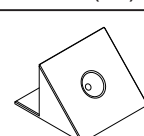
<p><b>A</b></p>  <p>2/+ Dowel Ø8,0 x 30mm (23x)</p>	<p><b>B</b></p>  <p>2/+ Cam Bolt (21x)</p>	<p><b>C</b></p>  <p>2/+ Cam Nut 15mm (11x)</p>	<p><b>D</b></p>  <p>2/+ Flan Head Screw Ø3,5 x 25mm (14x)</p>
<p><b>E</b></p>  <p>2/+ Dowel Ø6,0 x 30mm (56x)</p>	<p><b>F</b></p>  <p>2/+ Flat Head Screw Ø3,5 x 14mm (30x)</p>	<p><b>G</b></p>  <p>1/+ Pan Head Screw Ø4,0 x 35mm (8x)</p>	<p><b>H</b></p>  <p>2/+ Screw Ø6x8 (20x)</p>
<p><b>I</b></p>  <p>Handle (5x)</p>	<p><b>J</b></p>  <p>2/+ Cam Nut 12mm (10x)</p>	<p><b>K</b></p>  <p>2/+ Flat Head Screw Ø4,0 x 50mm (13x)</p>	<p><b>L</b></p>  <p>2/+ Flat Head Screw Ø3,5 x 16mm (16x)</p>
<p><b>M</b></p>  <p>Back Panel Strip 765mm (1x)</p>	<p><b>N</b></p>  <p>2/+ Flat Head Screw Ø4,0 x 40mm (10x)</p>	<p><b>O</b></p>  <p>Washer (2x)</p>	<p><b>P</b></p>  <p>2/+ Hole Plugs (26x)</p>
<p><b>Q</b></p>  <p>Glue (3x)</p>	<p><b>R</b></p>  <p>Strap (1x)</p>	<p><b>S</b></p>  <p>Slide 350mm (5x)</p>	<p><b>T</b></p>  <p>2/+ Nail 10 x 10 (21x)</p>
<p><b>U</b></p>  <p>2/+ Plastic Corner Bracket (16x)</p>			

### TIPS FOR FITTINGS CAM-LOCKS

WHEN FITTING CAM NUT. ENSURE STARTING POSITION IS CORRECT BEFORE YOU INSERT CONNECTING CAM BOLT TURN CLOCKWISE UNTIL SECURE



↑  
CORRECT



WRONG

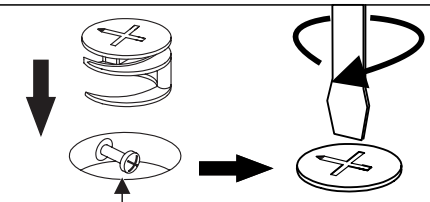

Cam bolt head needs to be in centre

**CAMBOLT**  
Tighten until shoulder is flush with panel. Do not overtighten or undertighten (see example beside)

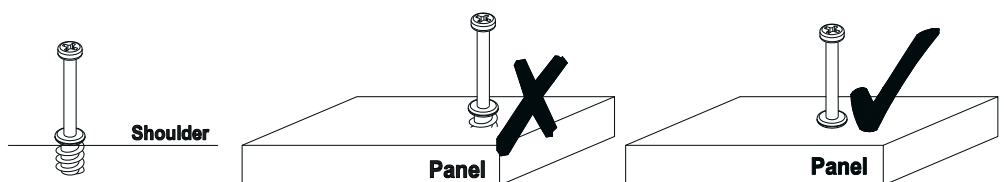

# STEP 1

## PARTS REQUIRED

1 - RIGHT SIDE PANEL (BLUE) x1

## HARDWARE REQUIRED

E  04  
Ø6,0 x 30mm

Q  01

## TOOLS REQUIRED

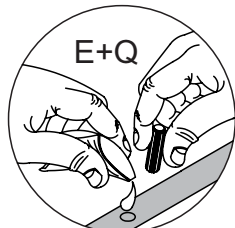
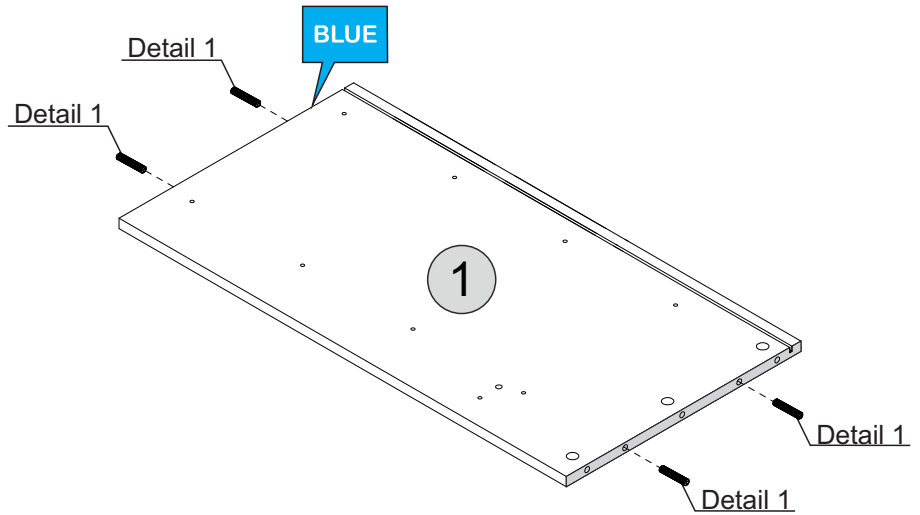
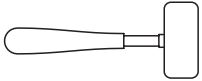

Detail 1

# STEP 2

## PARTS REQUIRED

1- RIGHT SIDE PANEL (BLUE) x1

## HARDWARE REQUIRED

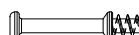
B  01

H  08  
Ø6x8mm

S  04  
RIGHT

## TOOLS REQUIRED

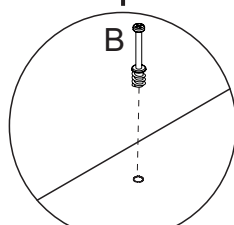
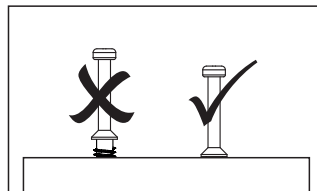
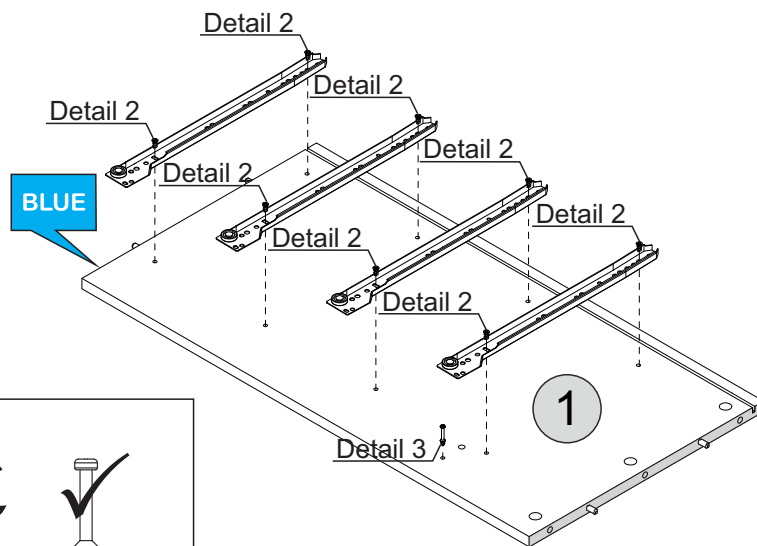

Detail 3

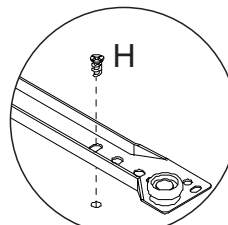

Detail 2

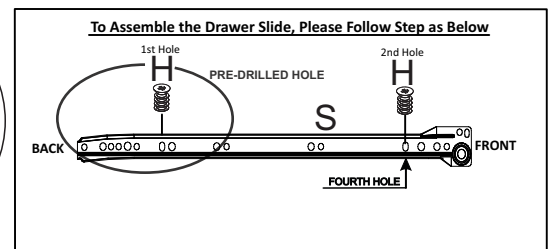

# STEP 3

## PARTS REQUIRED

3 - LEFT SIDE PANEL (RED) x1

## HARDWARE REQUIRED

E  04  
Ø6.0 x 30mm

Q  01  
GLUE

## TOOLS REQUIRED

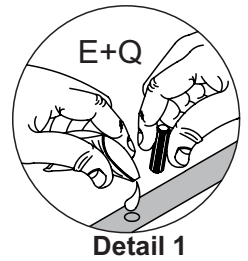
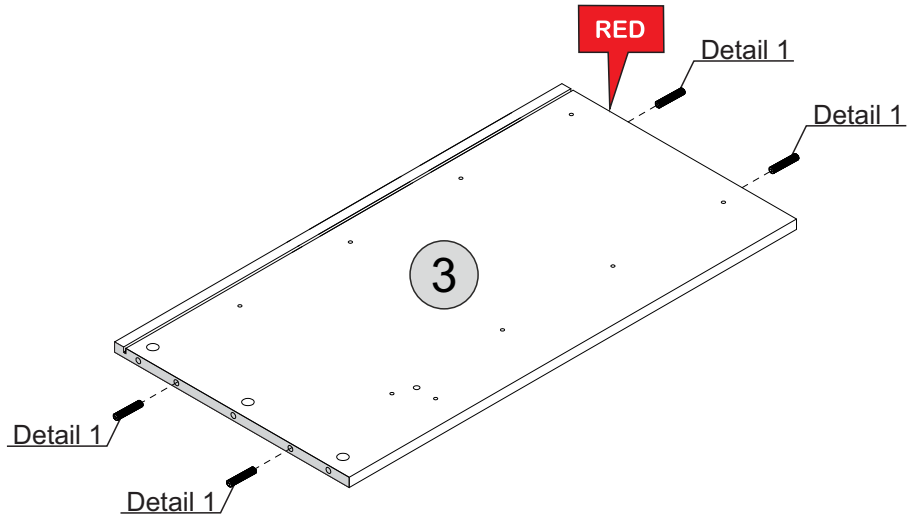
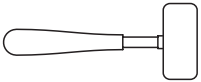



# STEP 4

## PARTS REQUIRED

3 - LEFT SIDE PANEL (RED) x1

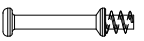
## HARDWARE REQUIRED

B  01

H  08  
Ø6x8mm

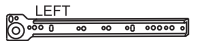
S  04  
LEFT

## TOOLS REQUIRED

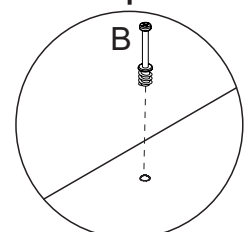
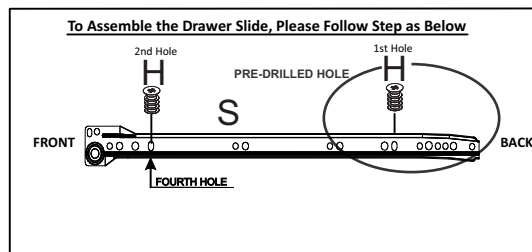
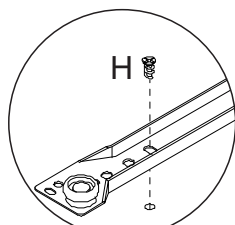
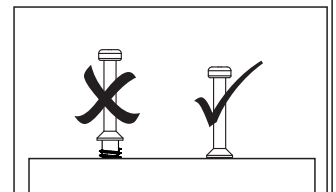
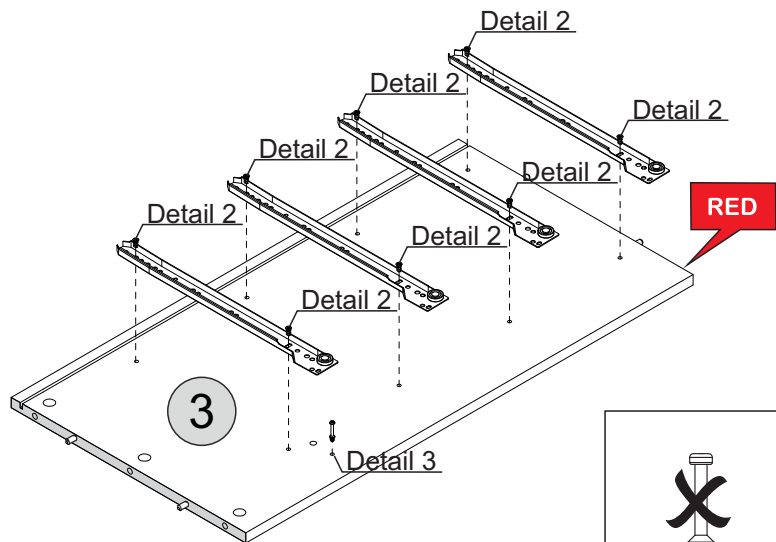
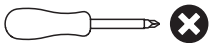



# STEP 5

## PARTS REQUIRED

7 - DIVISION (YELLOW) x1

## HARDWARE REQUIRED

- A  01  
Ø8,0 x 30mm
- E  02  
Ø6,0 x 30mm
- Q  01  
GLUE

## TOOLS REQUIRED

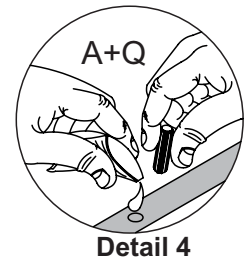
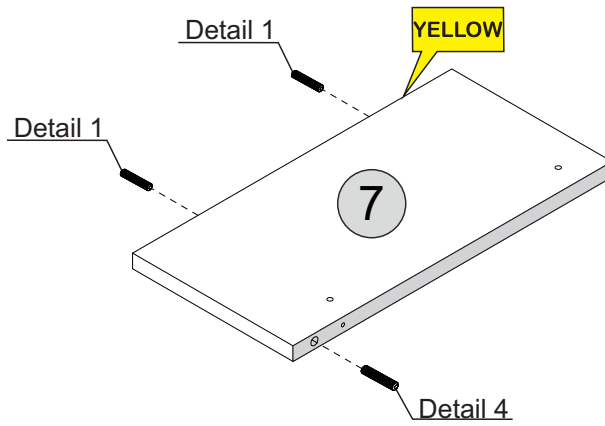
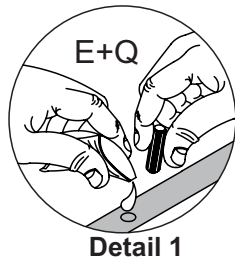
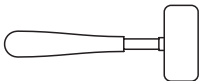



# STEP 6

## PARTS REQUIRED

7 - DIVISION (YELLOW) x1

## HARDWARE REQUIRED

- H  04  
Ø6x8mm
- S  01  
RIGHT
- S  01  
LEFT

## TOOLS REQUIRED

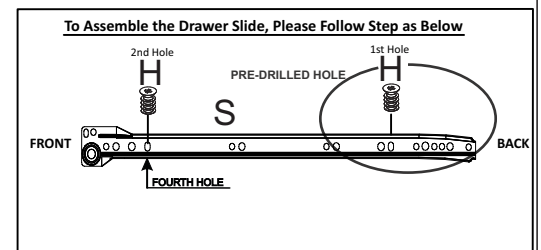
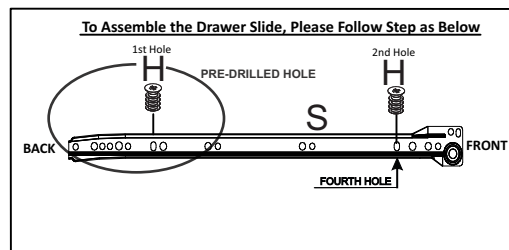
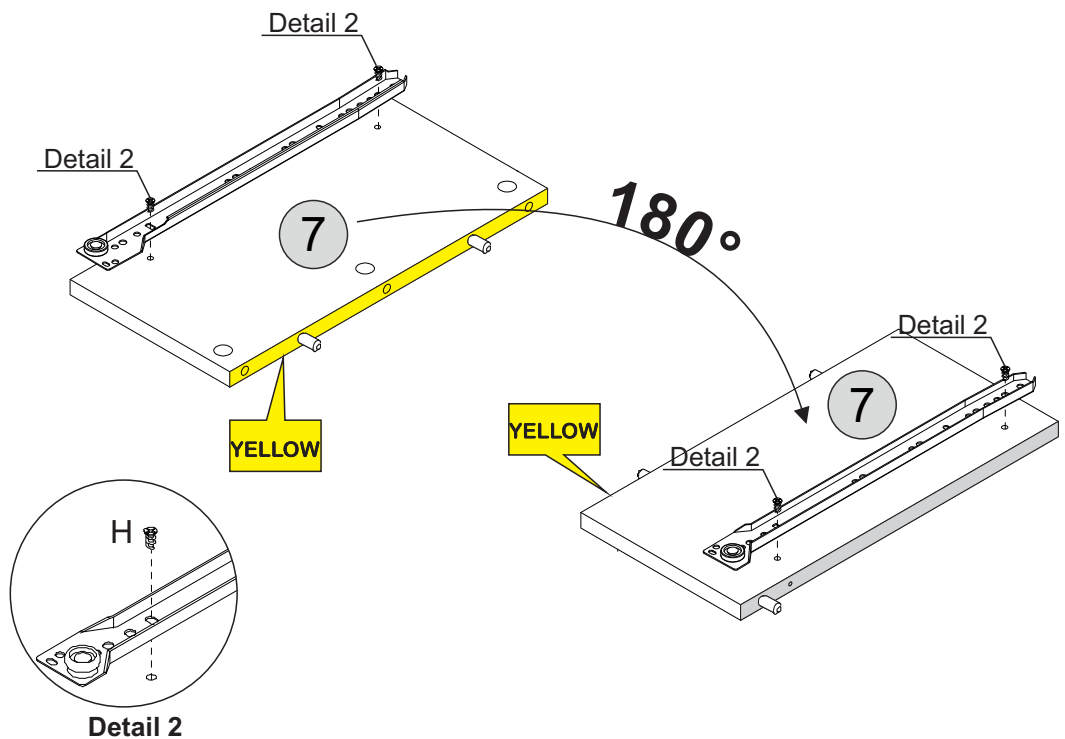

# STEP 7

## PARTS REQUIRED

6 - TOP PANEL (GREEN) x1

## HARDWARE REQUIRED

B  09

## TOOLS REQUIRED

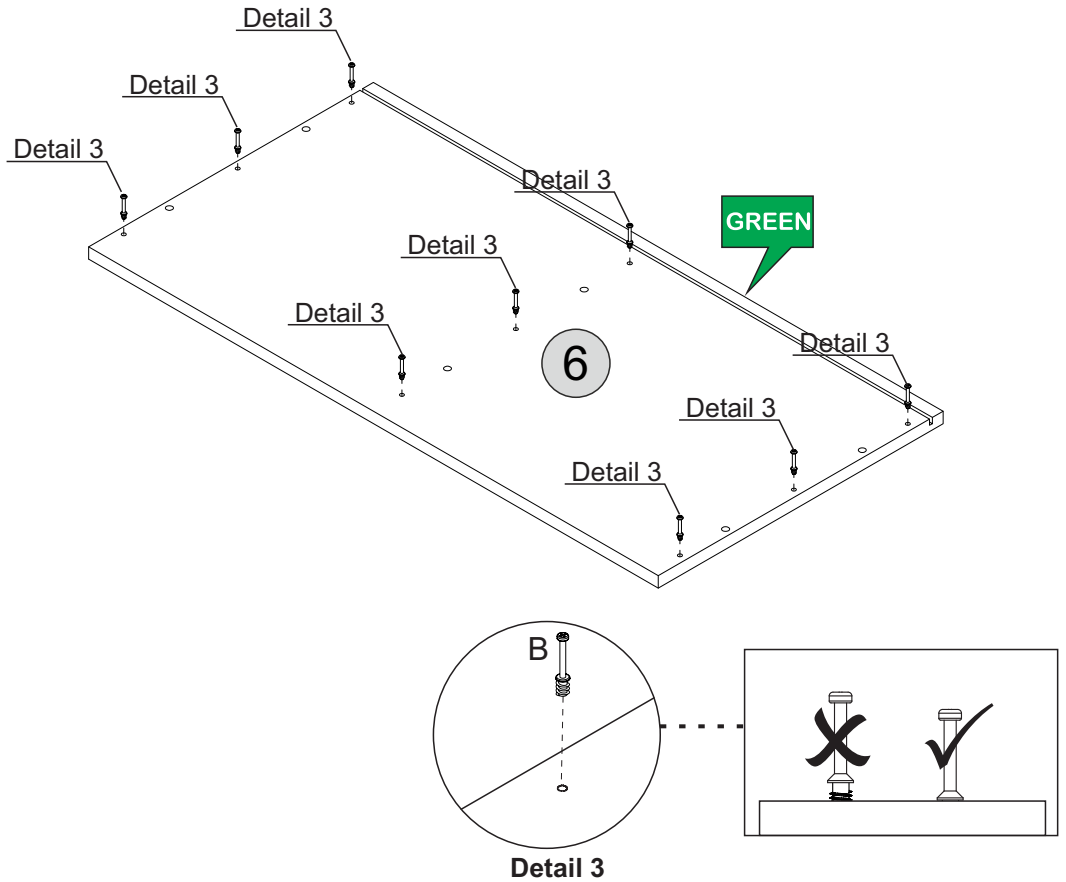
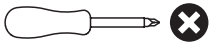

# STEP 8

## PARTS REQUIRED

2 - CROSSBAR (YELLOW) x1

## HARDWARE REQUIRED

A  02  
Ø8,0 x 30mm

Q  01  
GLUE

## TOOLS REQUIRED

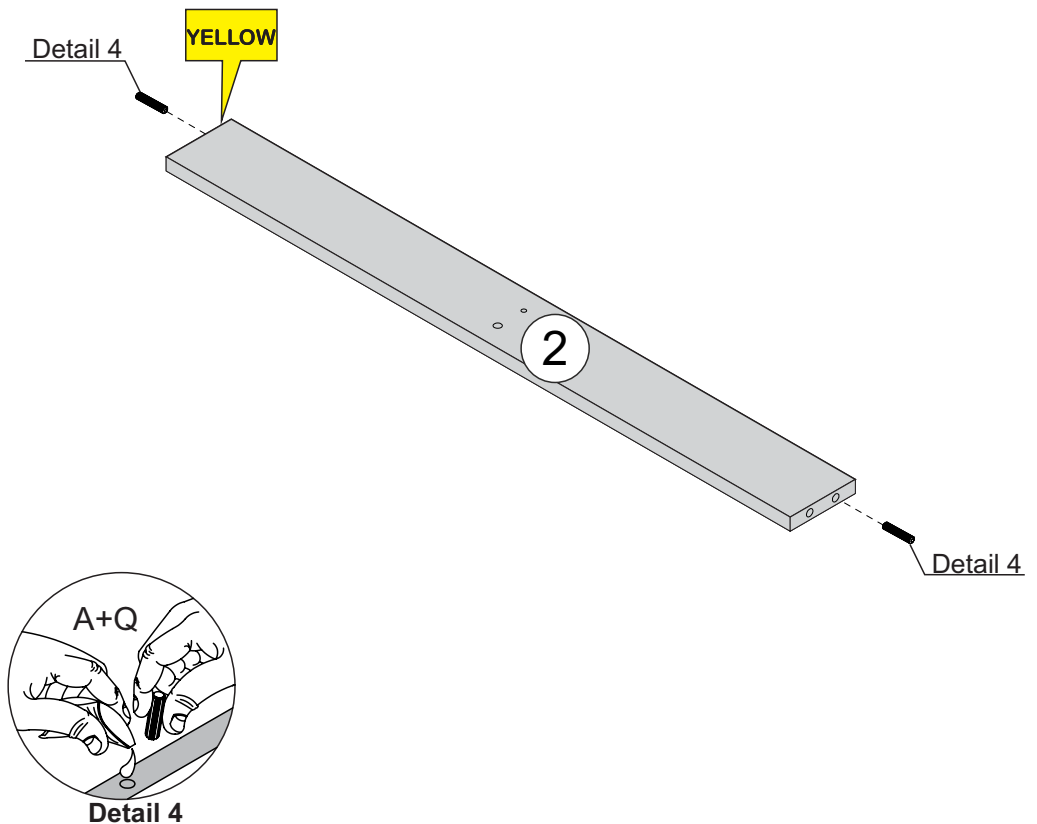
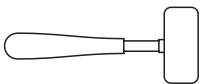

# STEP 9

## PARTS REQUIRED

1 - RIGHT SIDE PANEL (BLUE) x1

2 - CROSSBAR (YELLOW) x1

3 - LEFT SIDE PANEL (RED) x1

## HARDWARE REQUIRED

C  Ø15mm 02

Q  GLUE 01

## TOOLS REQUIRED

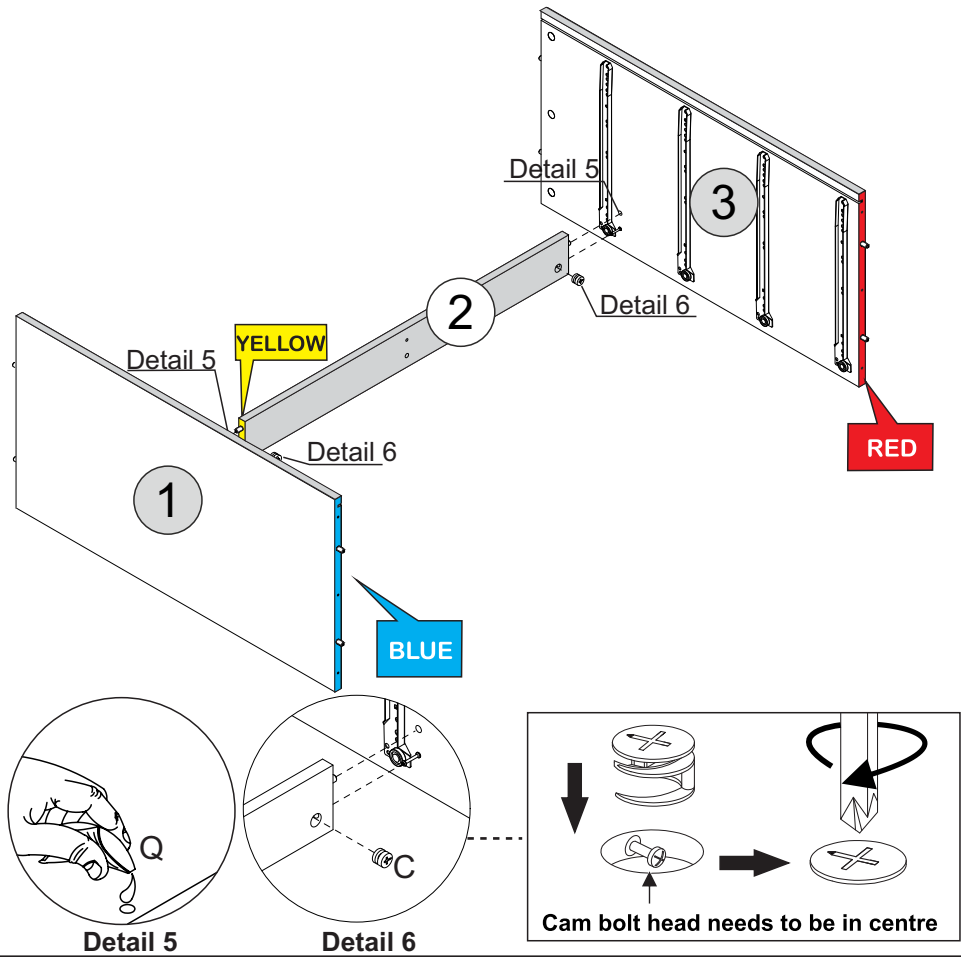
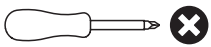

# STEP 10

## PARTS REQUIRED

4 - BASE PANEL (BLACK) x1

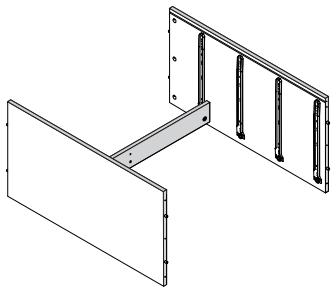

## HARDWARE REQUIRED

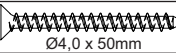
K  Ø4.0 x 50mm 06

Q  GLUE 01

## TOOLS REQUIRED

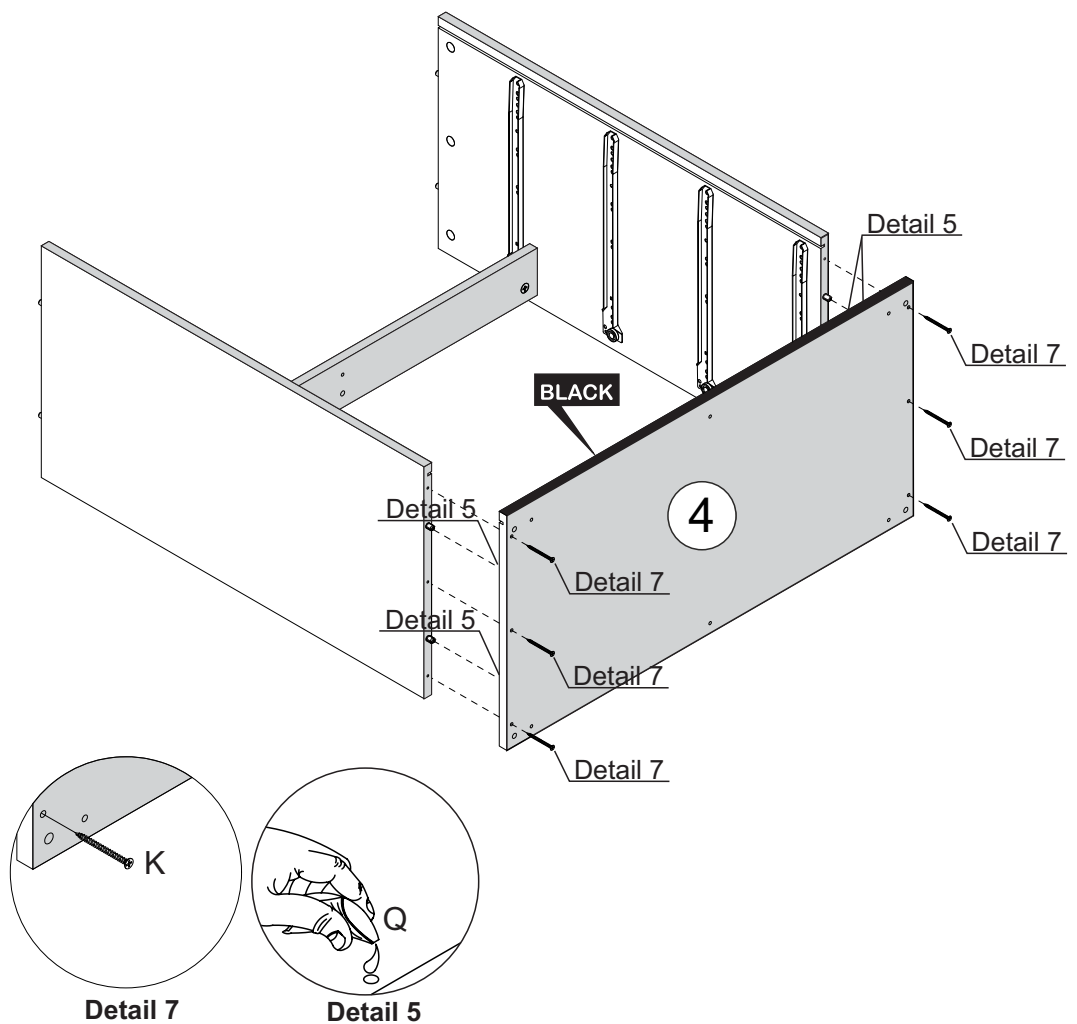
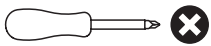



# STEP 11

**PARTS REQUIRED**

5 - BACK PANEL x2

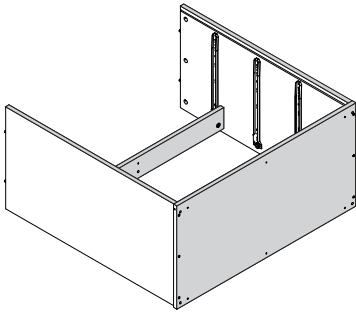

**HARDWARE REQUIRED**

M 01

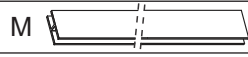

**TOOLS REQUIRED**

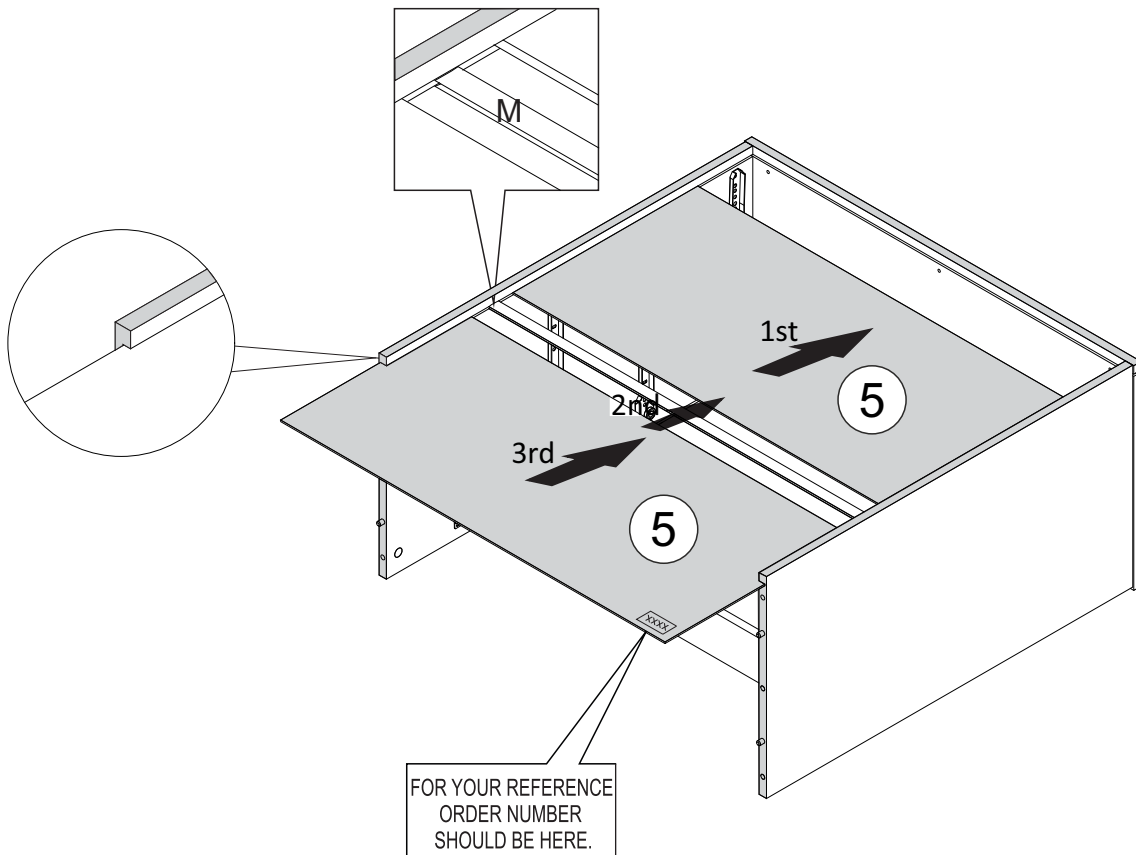
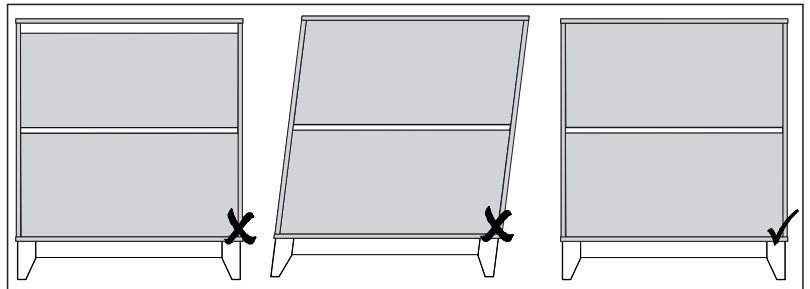

# STEP 12

## PARTS REQUIRED

6 - TOP PANEL (GREEN) x1

7 - DIVISION (YELLOW) x1

## HARDWARE REQUIRED

C  Ø15mm 03

Q  GLUE 01

## TOOLS REQUIRED

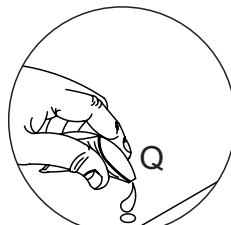
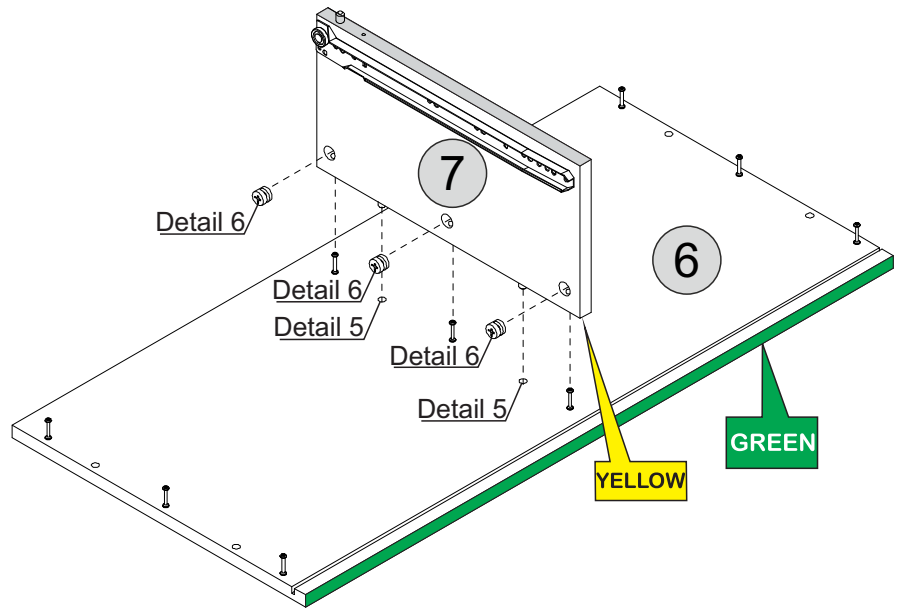
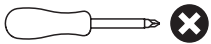

Detail 5

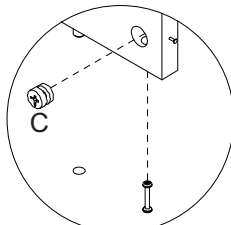

Detail 6

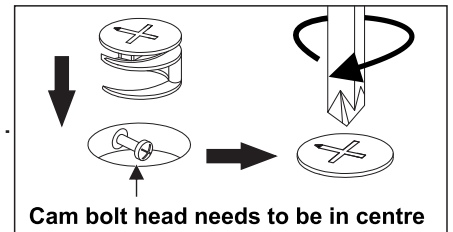

Cam bolt head needs to be in centre

# STEP 13

## PARTS REQUIRED

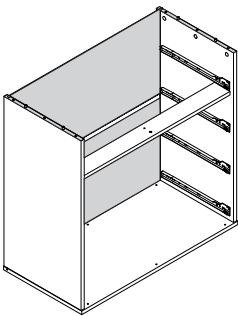

## HARDWARE REQUIRED

C  Ø15mm 06

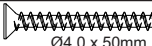
K  Ø4,0 x 50mm 01

Q  GLUE 01

## TOOLS REQUIRED

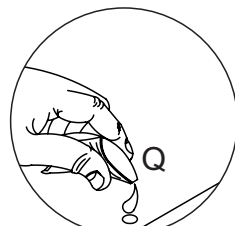
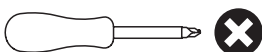

Detail 5

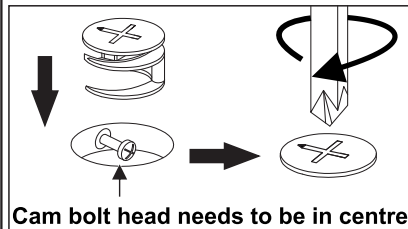

Cam bolt head needs to be in centre

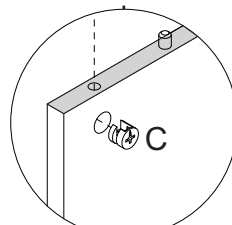

Detail 6

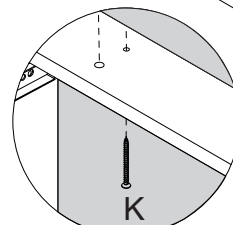

Detail 7

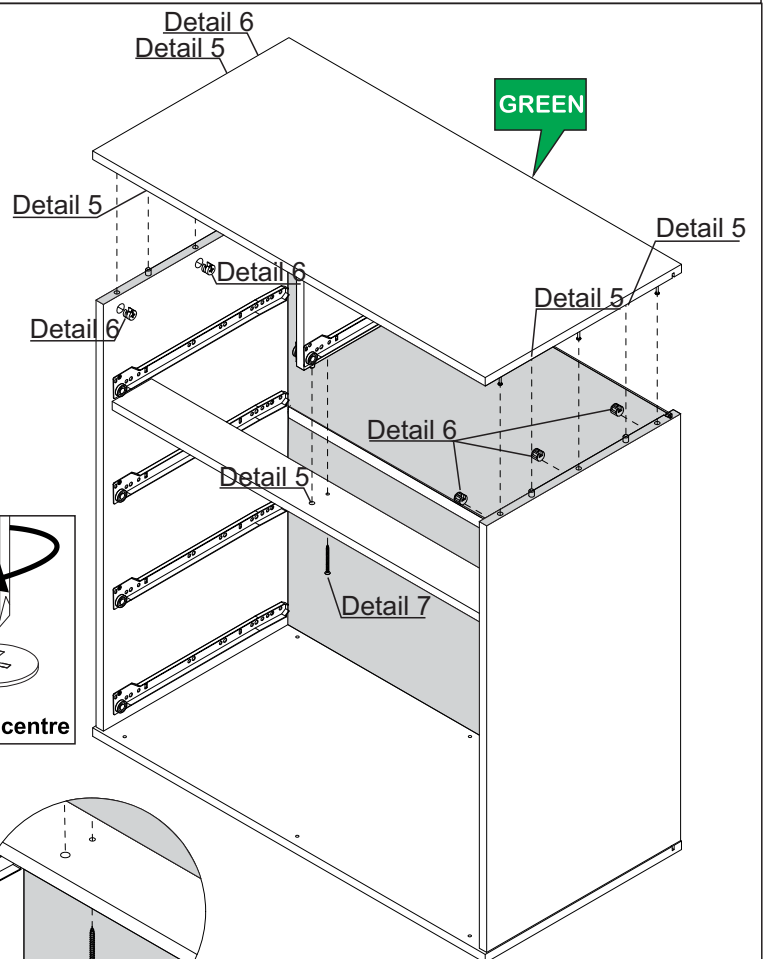

# STEP 14

## PARTS REQUIRED

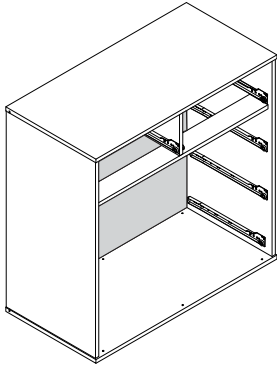

## HARDWARE REQUIRED

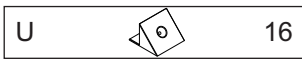
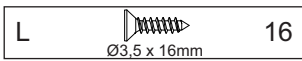

## TOOLS REQUIRED

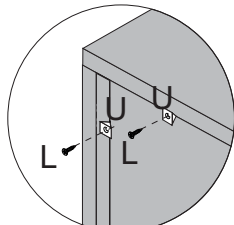
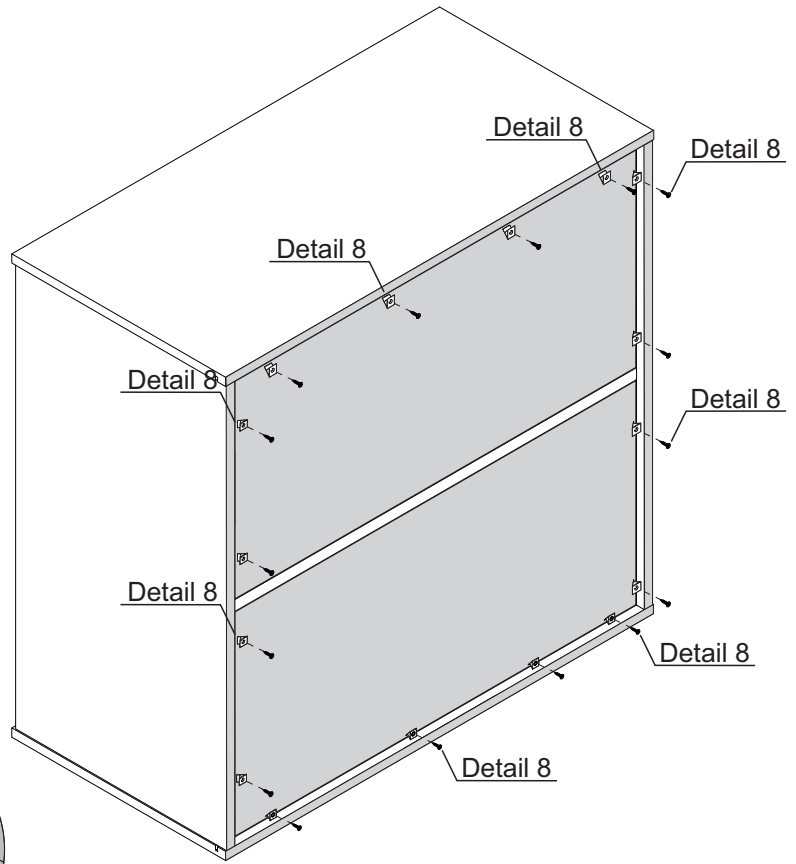
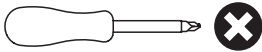

Detail 8

# STEP 15

## PARTS REQUIRED

8 - RIGHT LEG	x2
---------------	----

10 - LEFT LEG	x2
---------------	----

## HARDWARE REQUIRED

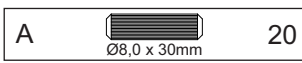

## TOOLS REQUIRED

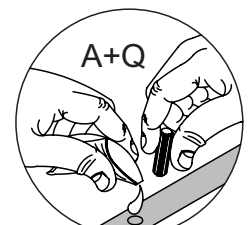
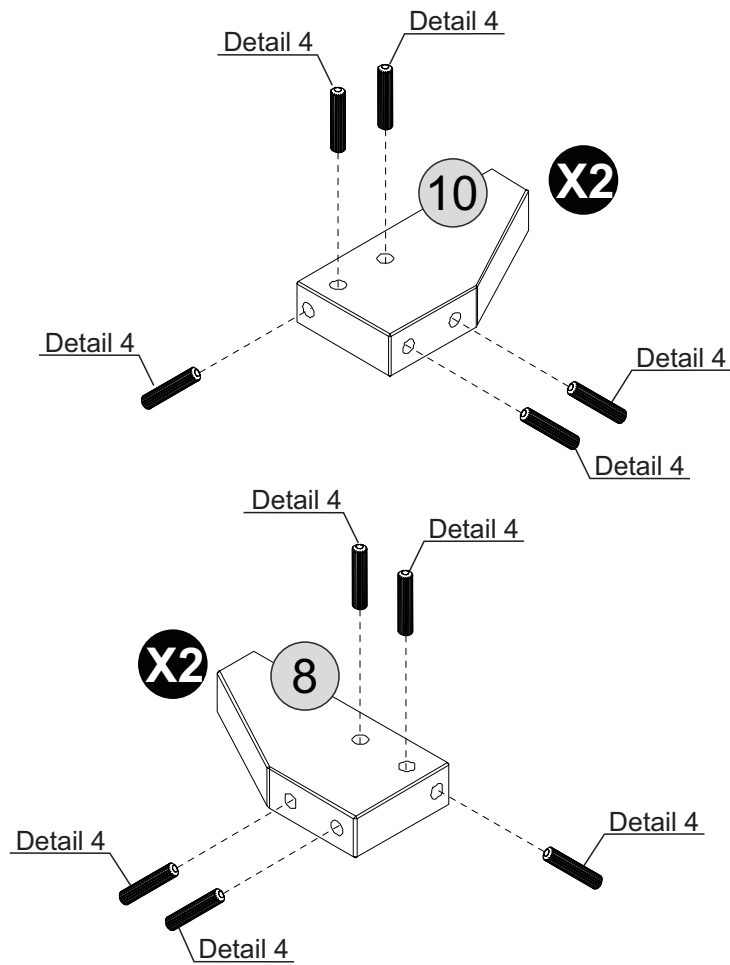
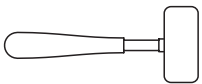

Detail 4

# STEP 16

## PARTS REQUIRED

8 - RIGHT LEG x2

9- LEG SUPPORT FRONT & BACK x2

10 - LEFT LEG x2

## HARDWARE REQUIRED

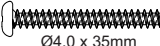
G  04  
Ø4.0 x 35mm

Q  01

## TOOLS REQUIRED

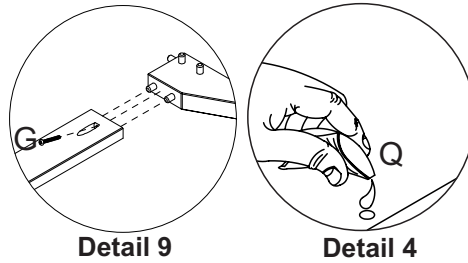
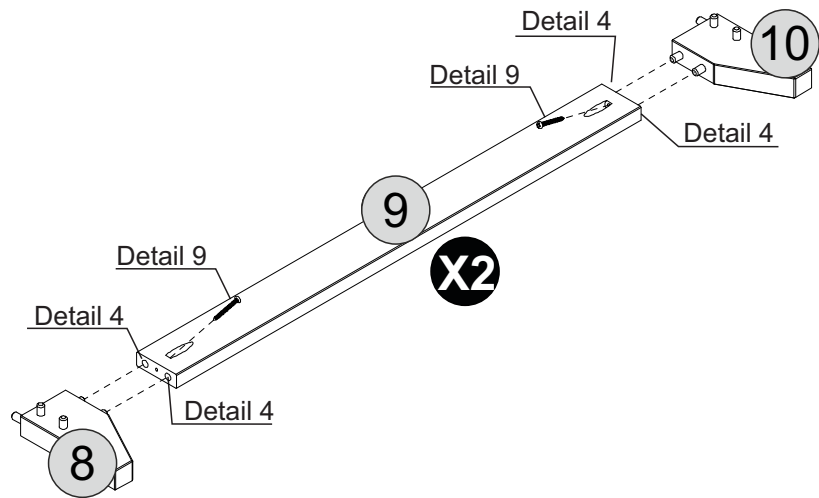
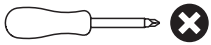

# STEP 17

## PARTS REQUIRED

11- LEG SUPPORT LEFT & RIGHT x2

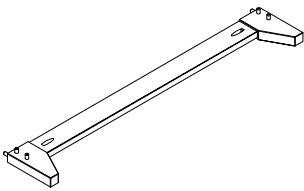

## HARDWARE REQUIRED

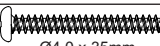
G  02  
Ø4.0 x 35mm

Q  01

## TOOLS REQUIRED

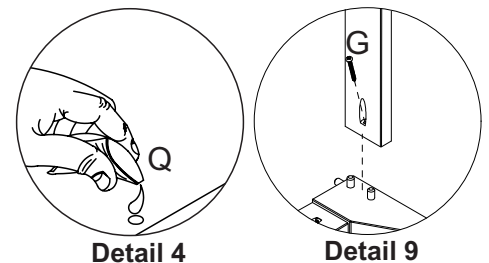
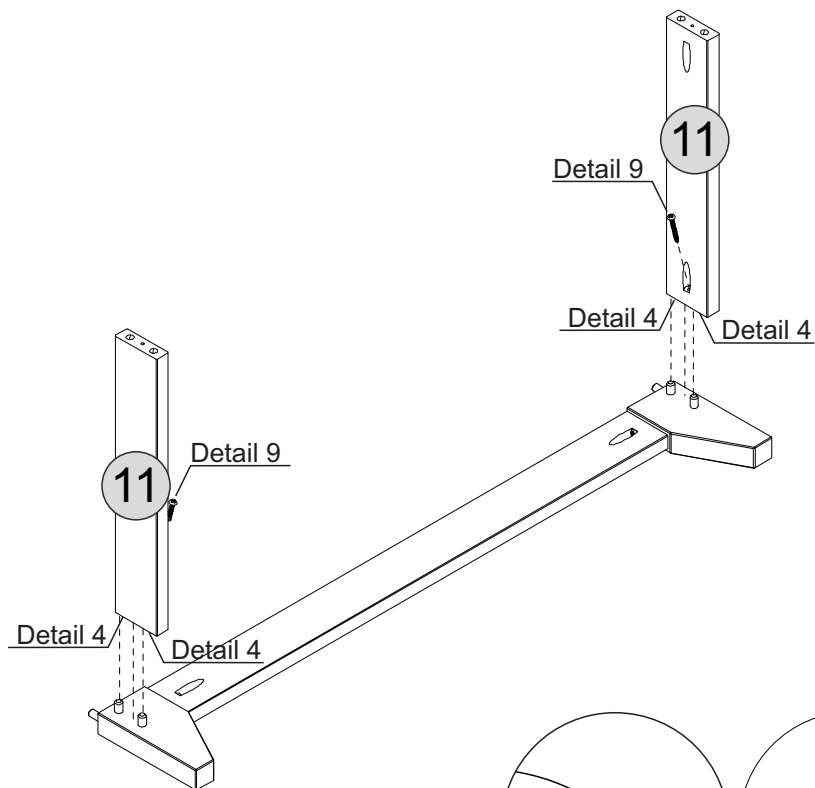
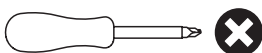

# STEP 18

**PARTS REQUIRED**

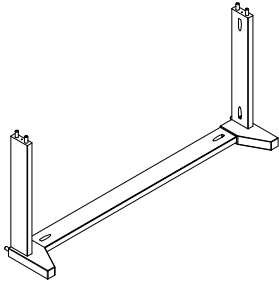

**HARDWARE REQUIRED**

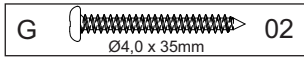

**TOOLS REQUIRED**

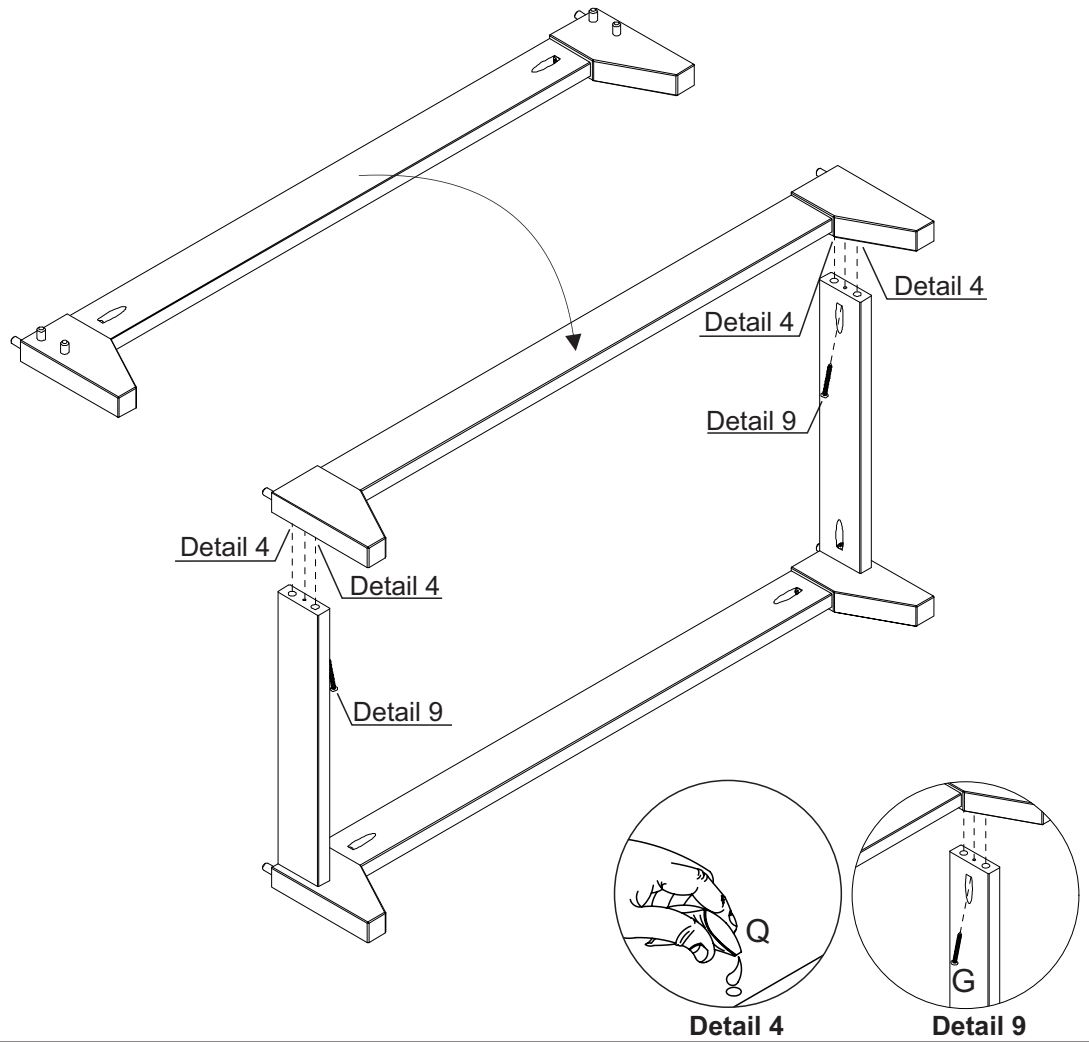
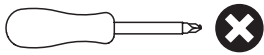

# STEP 19

**PARTS REQUIRED**

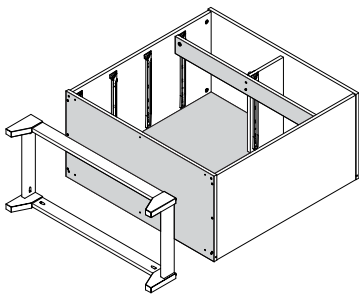

**HARDWARE REQUIRED**

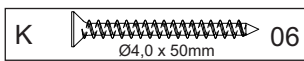

**TOOLS REQUIRED**

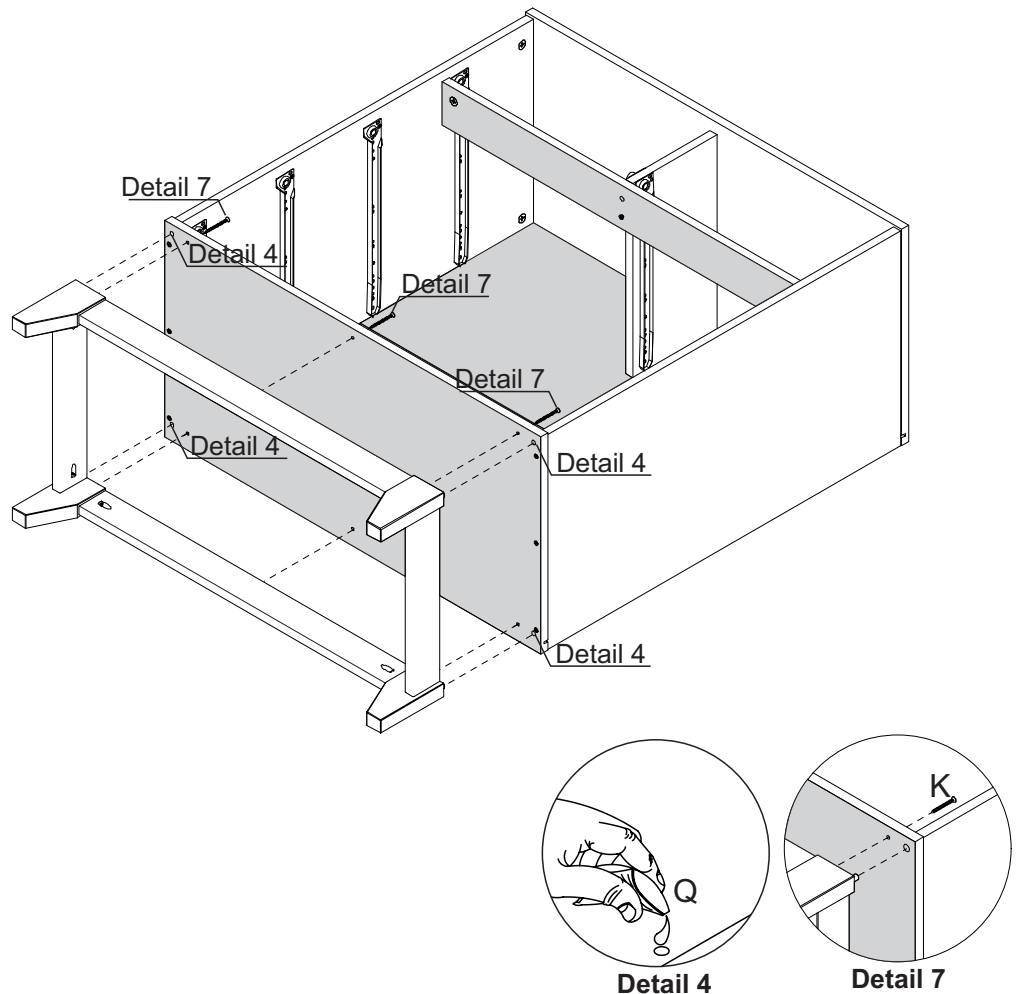
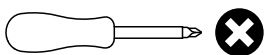

# STEP 20

## PARTS REQUIRED

12 - DRAWER SIDES (BLUE) x10

13 - LARGE DRAWER BACK (YELLOW) x3

16 - DRAWER BASE SUPPORT (BLACK) x3

17 - SMALL DRAWER BACK (RED) x3

## HARDWARE REQUIRED

E  46  
Ø6,0 x 30mm

Q  01

## TOOLS REQUIRED

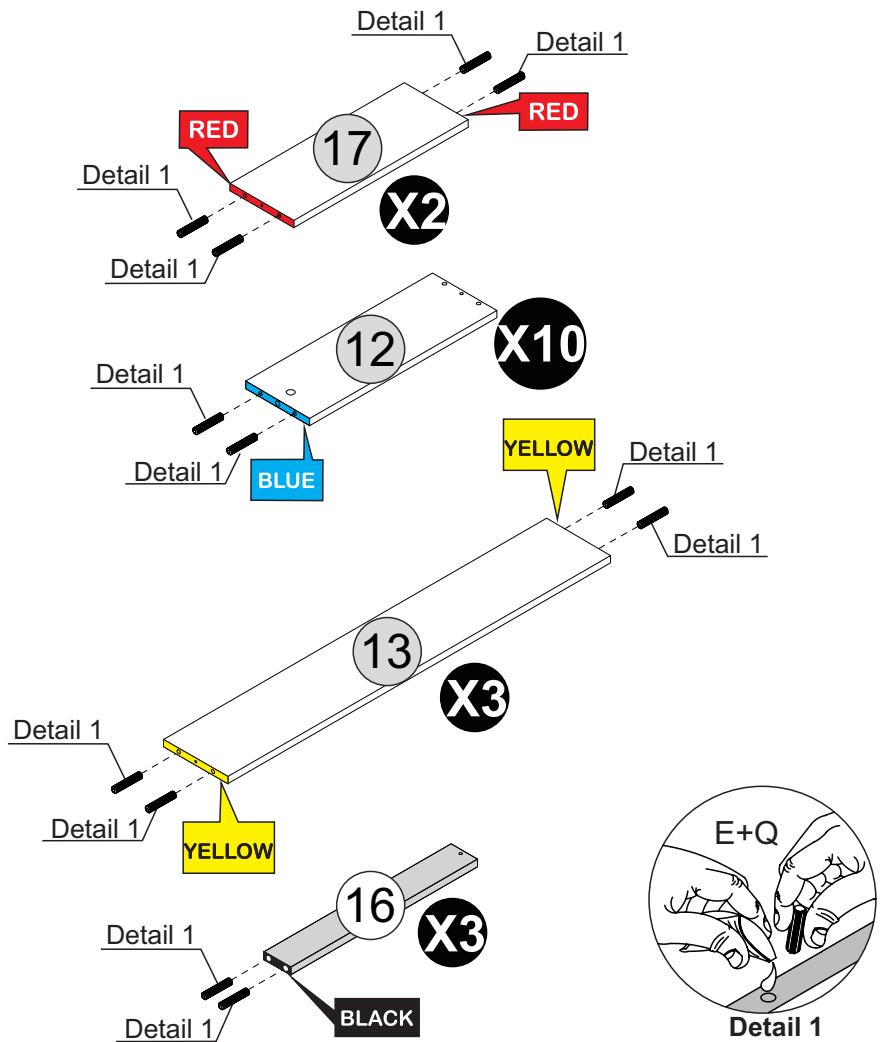
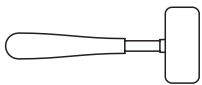

# STEP 21

## PARTS REQUIRED

14 - LARGE DRAWER FRONT x3

18 - LEFT SMALL DRAWER FRONT x1

19 - RIGHT SMALL DRAWER FRONT x1

## HARDWARE REQUIRED

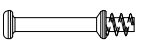
B  10

## TOOLS REQUIRED

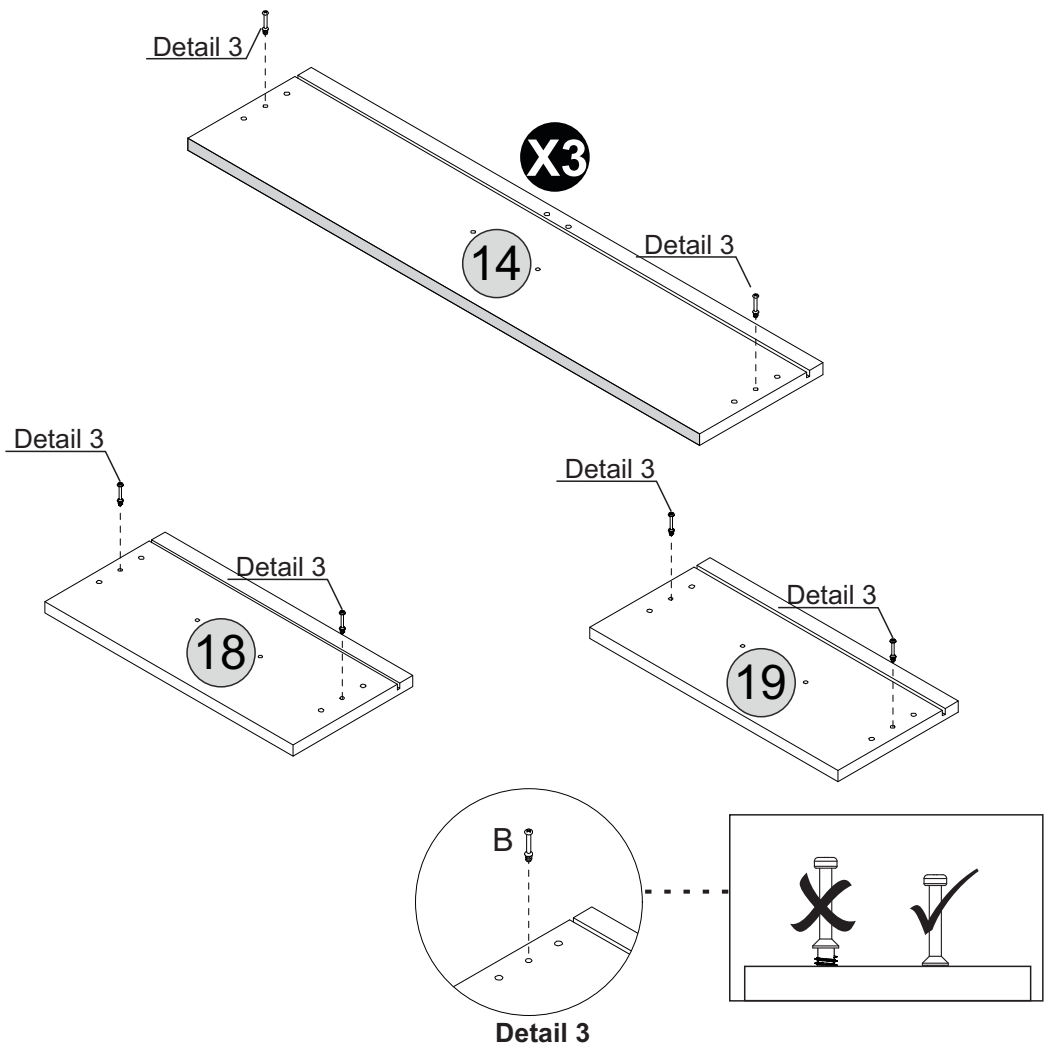
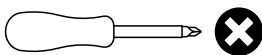

# STEP 22

## PARTS REQUIRED

12 - DRAWER SIDES (BLUE) x4

17 - SMALL DRAWER BACK (RED) x2

## HARDWARE REQUIRED

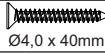
N  04  
Ø4,0 x 40mm

Q  01

## TOOLS REQUIRED

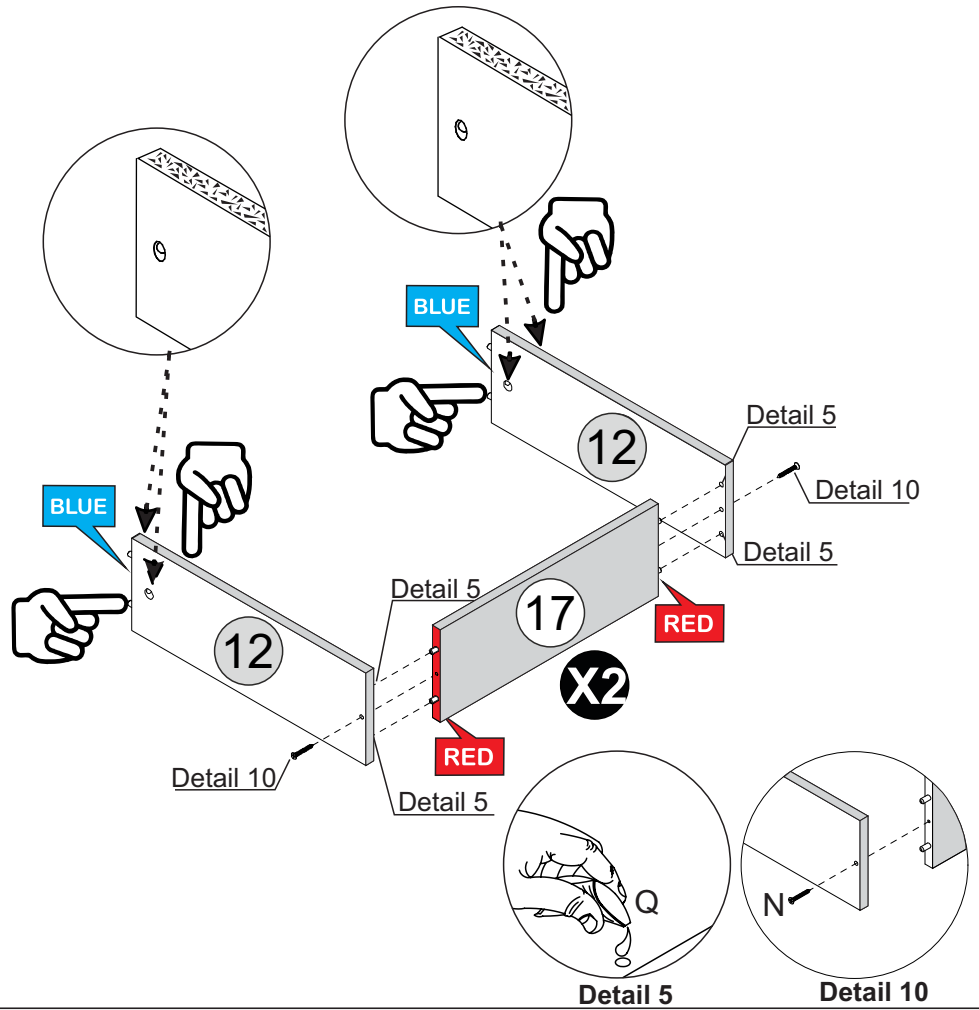
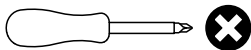

# STEP 23

## PARTS REQUIRED

18 - LEFT SMALL DRAWER FRONT x1

19 - RIGHT SMALL DRAWER FRONT x1

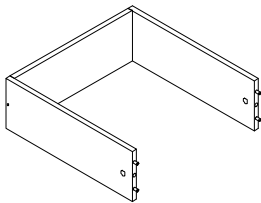

## HARDWARE REQUIRED

J  04  
Ø12mm

Q  01

## TOOLS REQUIRED

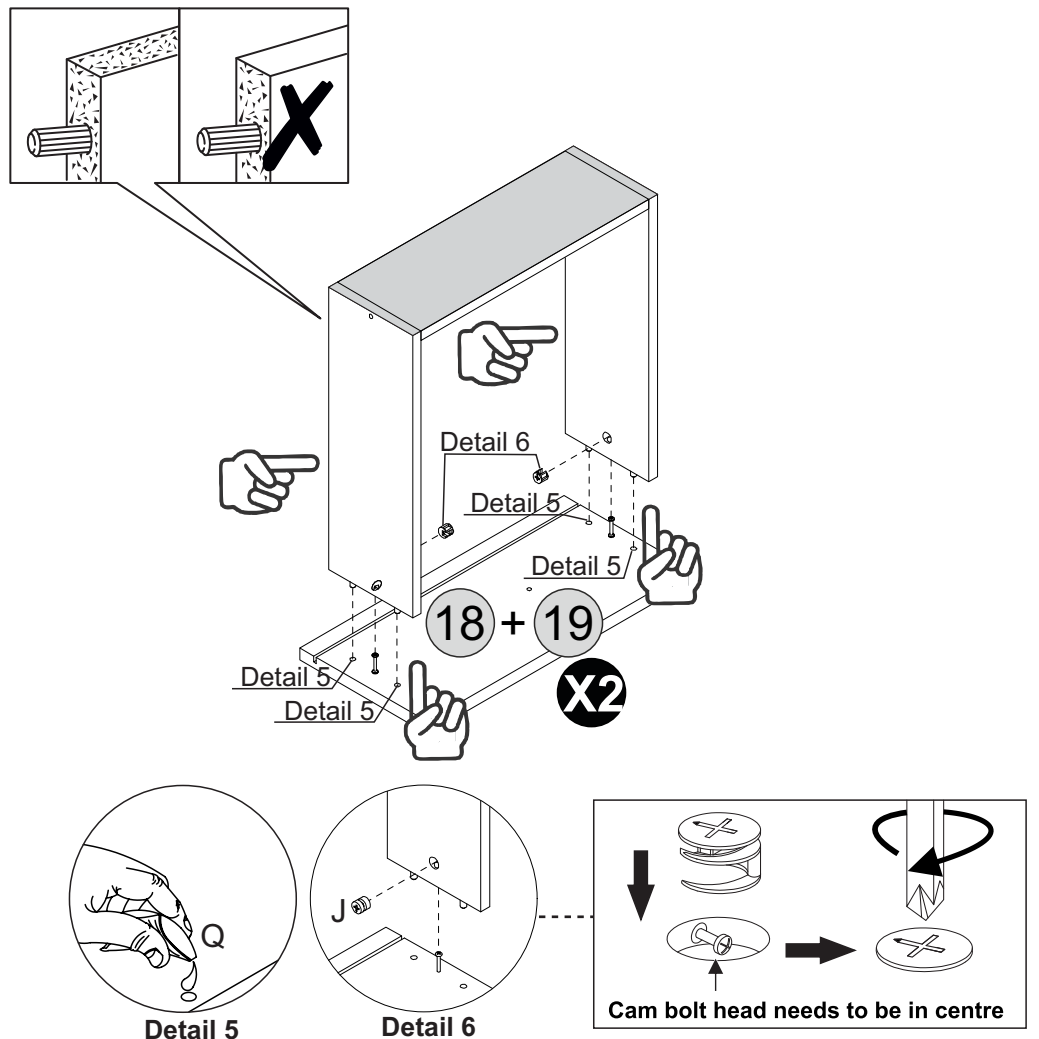
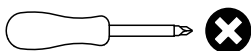

# STEP 24

## PARTS REQUIRED

20 - SMALL DRAWER BASE x2

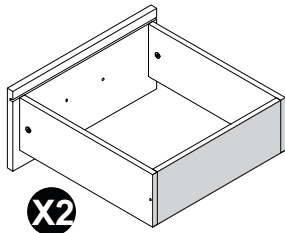

## HARDWARE REQUIRED

Q  01

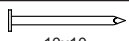
T  06  
10x10

## TOOLS REQUIRED

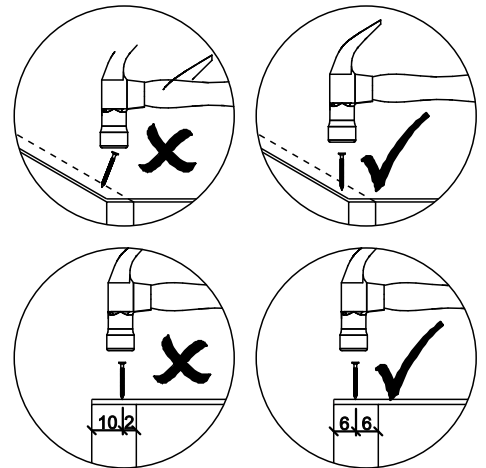
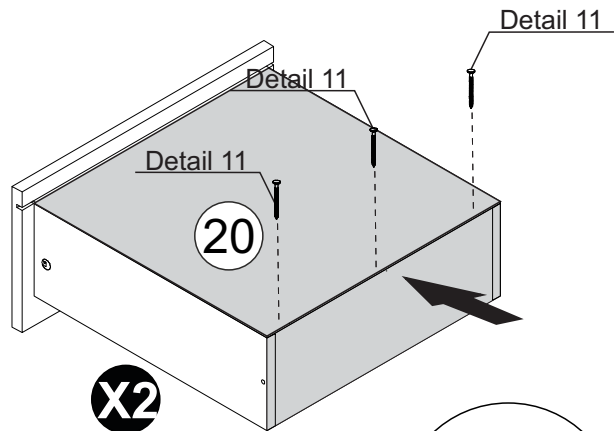
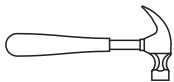

# STEP 25

## PARTS REQUIRED

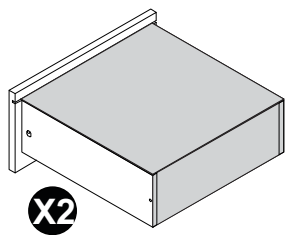

## HARDWARE REQUIRED

F  08  
Ø3.5x14mm

S  LEFT 02

S  RIGHT 02

## TOOLS REQUIRED

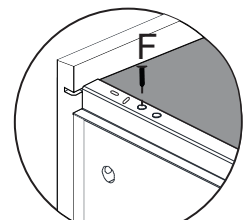
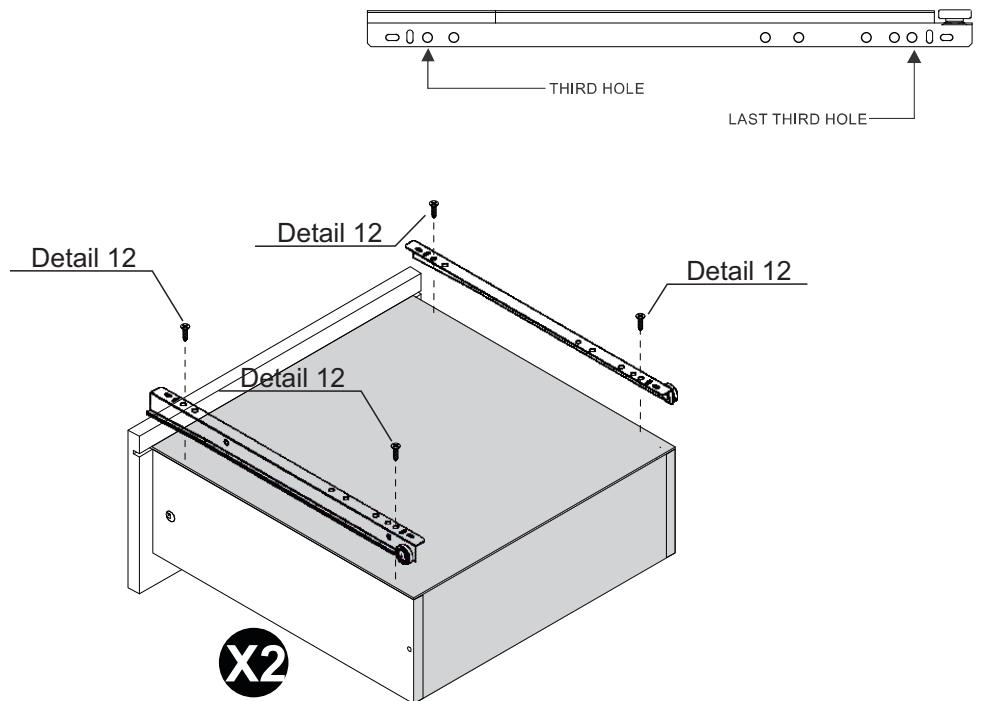
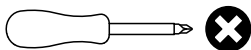

Detail 12



# STEP 26

## PARTS REQUIRED

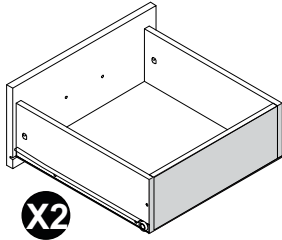

## HARDWARE REQUIRED

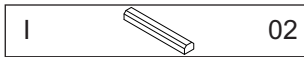
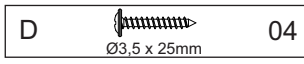

## TOOLS REQUIRED

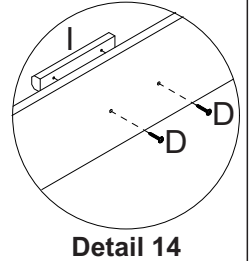
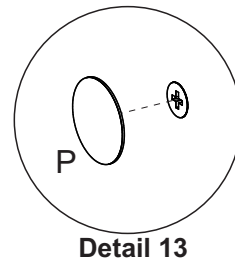
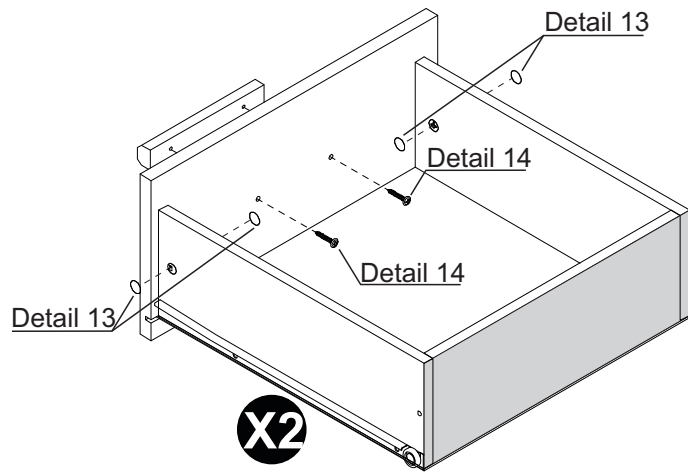
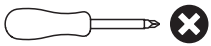

# STEP 27

## PARTS REQUIRED

12 - DRAWER SIDES (BLUE) x6

13 - LARGE DRAWER BACK (YELLOW) x3

## HARDWARE REQUIRED

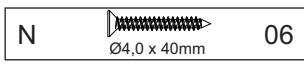

## TOOLS REQUIRED

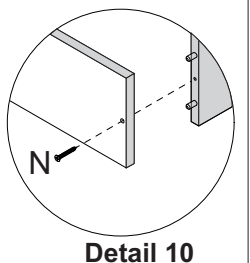
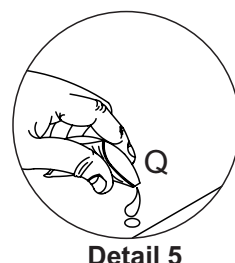
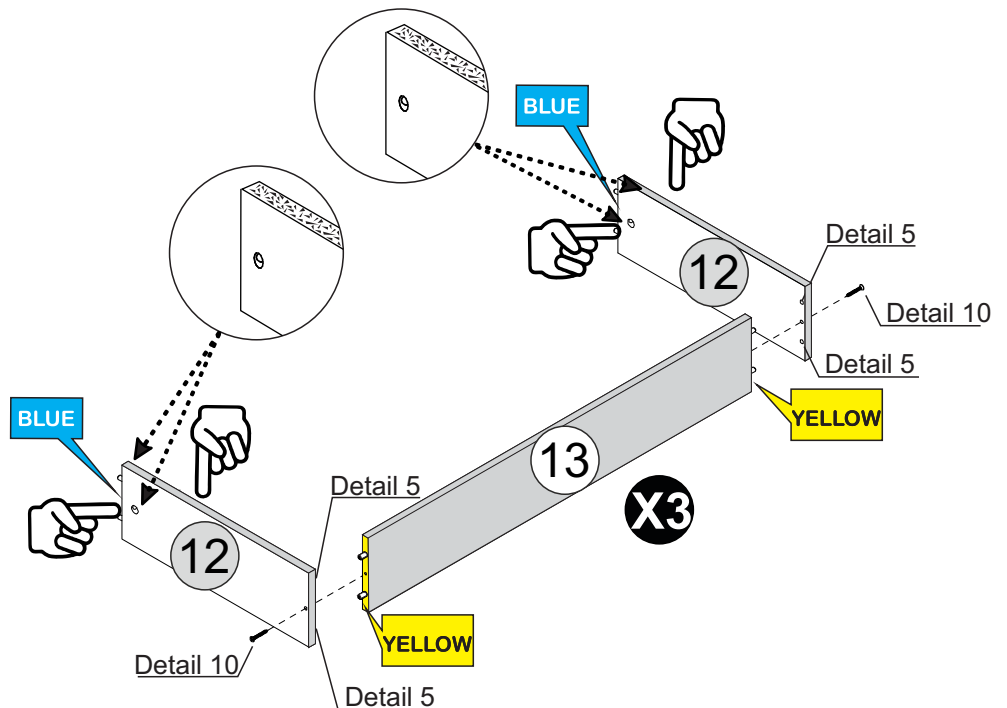
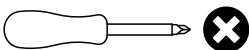

# STEP 28

## PARTS REQUIRED

14 - LARGE DRAWER FRONT x3

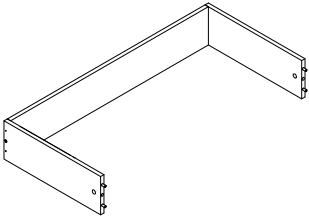

## HARDWARE REQUIRED

J  Ø12mm 06

Q  GLUE 01

## TOOLS REQUIRED

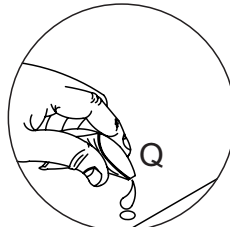
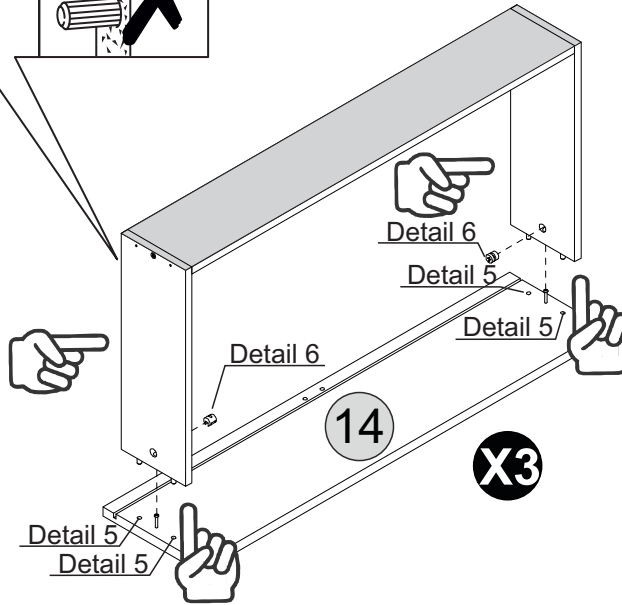
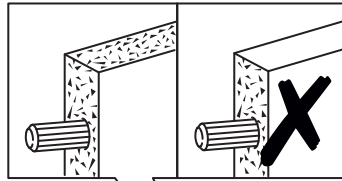
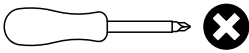

Detail 5

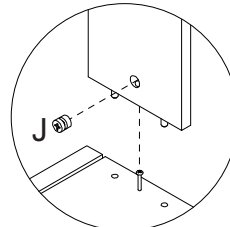

Detail 6

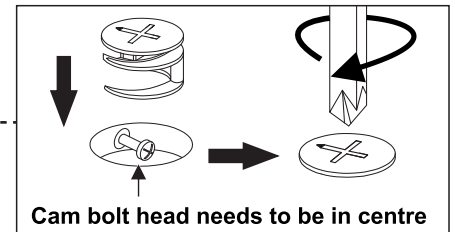

# STEP 29

## PARTS REQUIRED

15 - LARGE DRAWER BASE x3

16 - DRAWER BASE SUPPORT (BLACK) x3

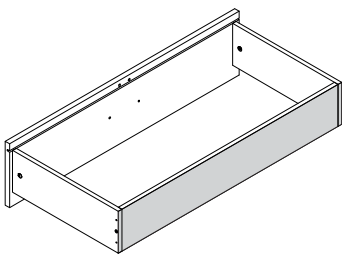

## HARDWARE REQUIRED

Q  GLUE 01

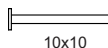
T  10x10 12

## TOOLS REQUIRED

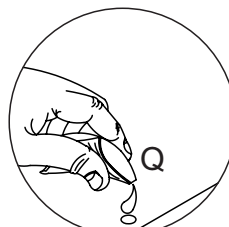
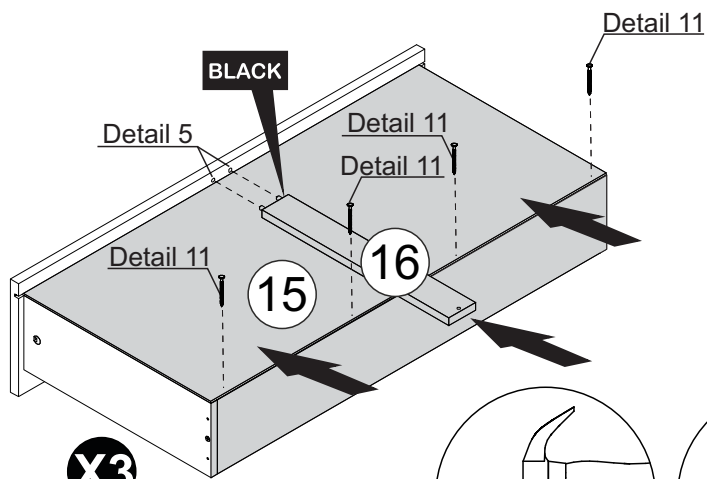
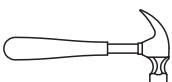

Detail 5

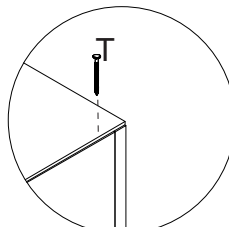

Detail 11

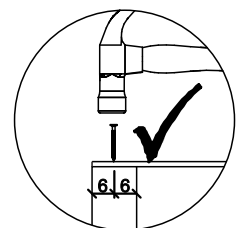
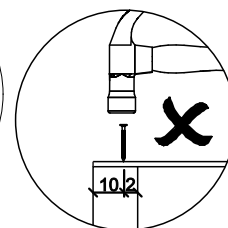
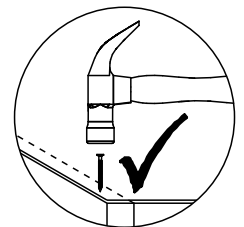
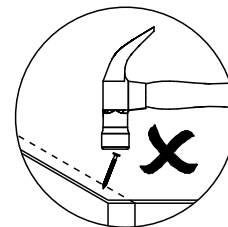

# STEP 30

## PARTS REQUIRED

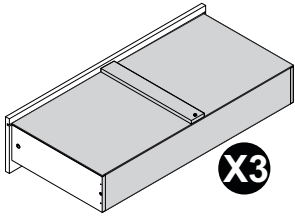

## HARDWARE REQUIRED

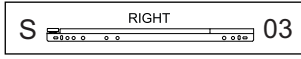
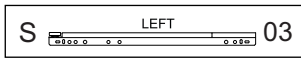
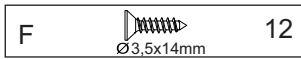
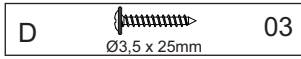

## TOOLS REQUIRED

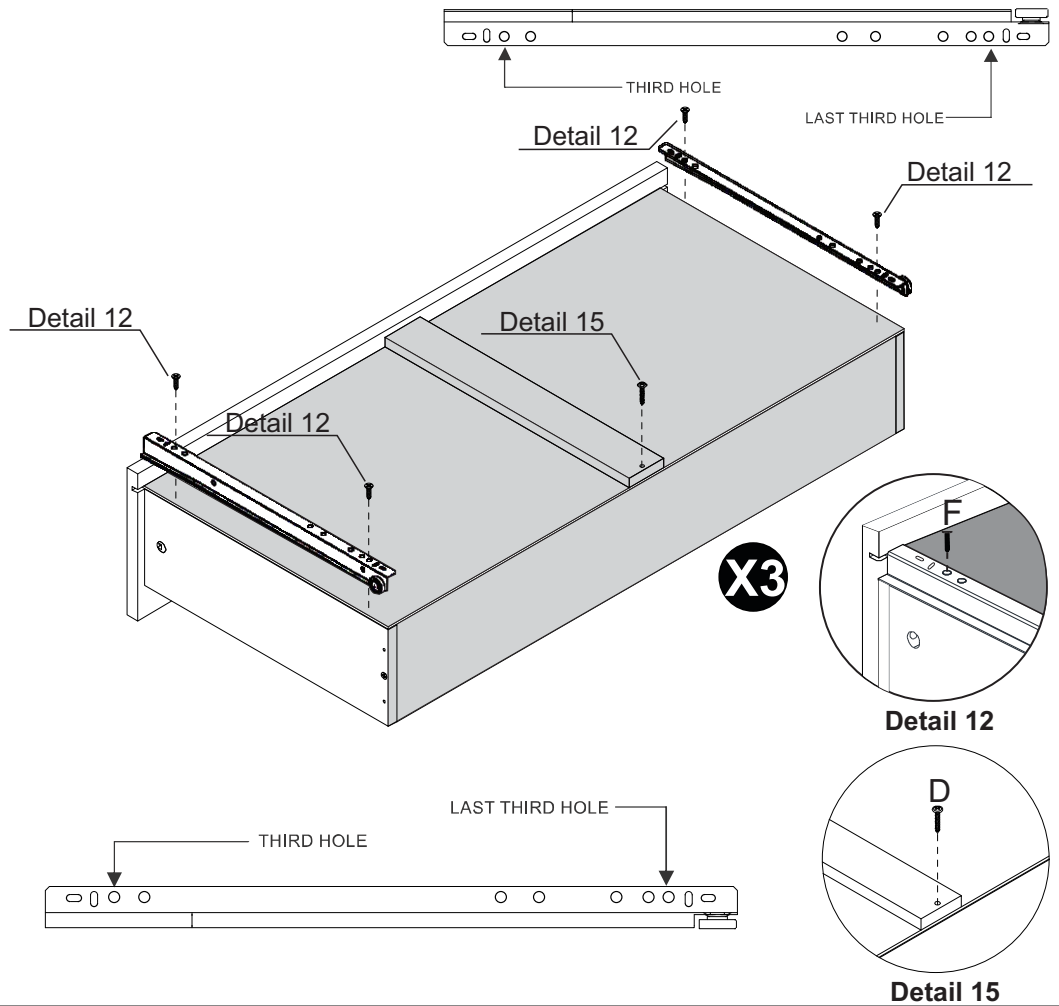
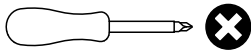

# STEP 31

## PARTS REQUIRED

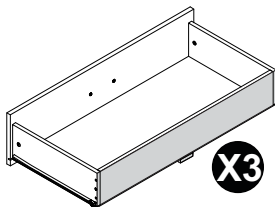

## HARDWARE REQUIRED

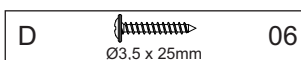

## TOOLS REQUIRED

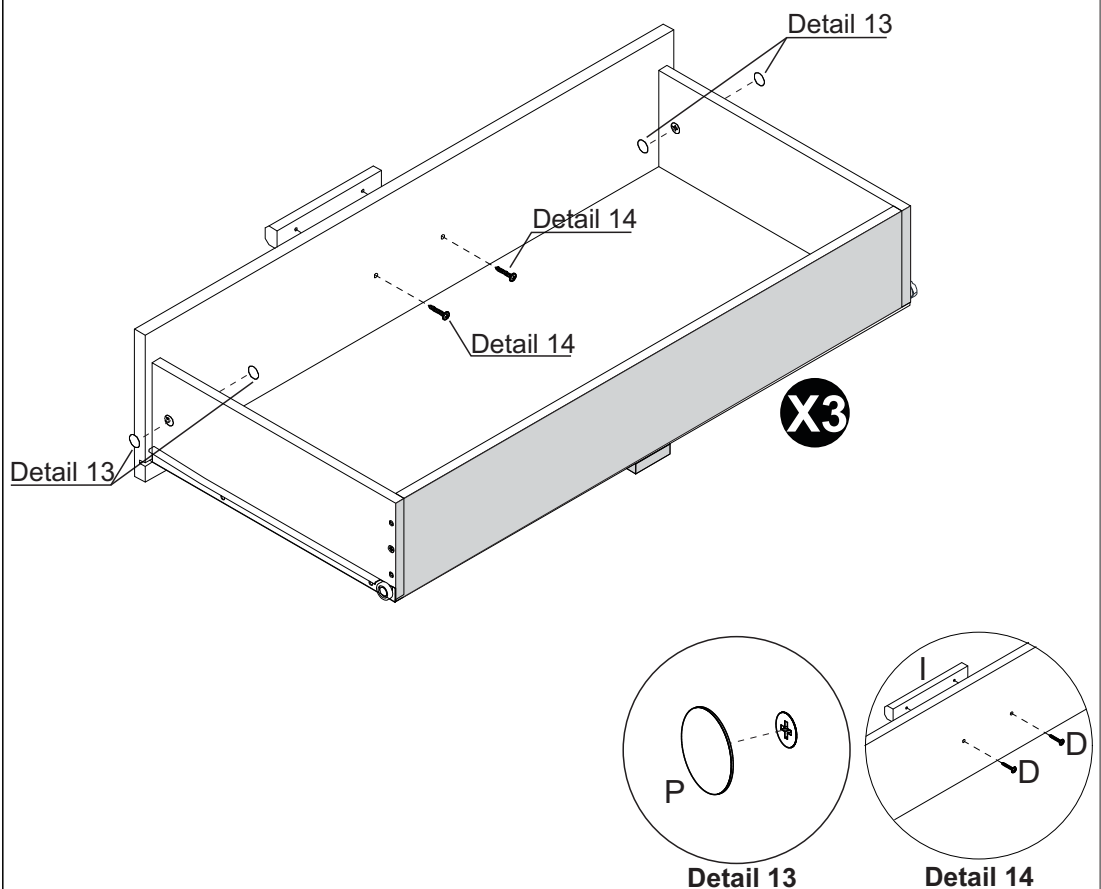

# STEP 32

PARTS REQUIRED

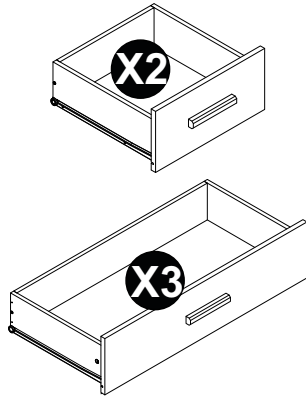
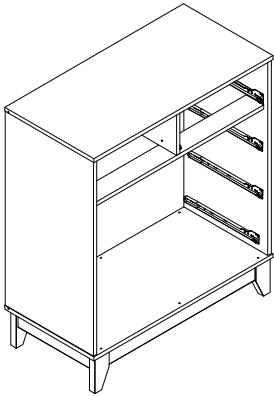

HARDWARE REQUIRED

TOOLS REQUIRED

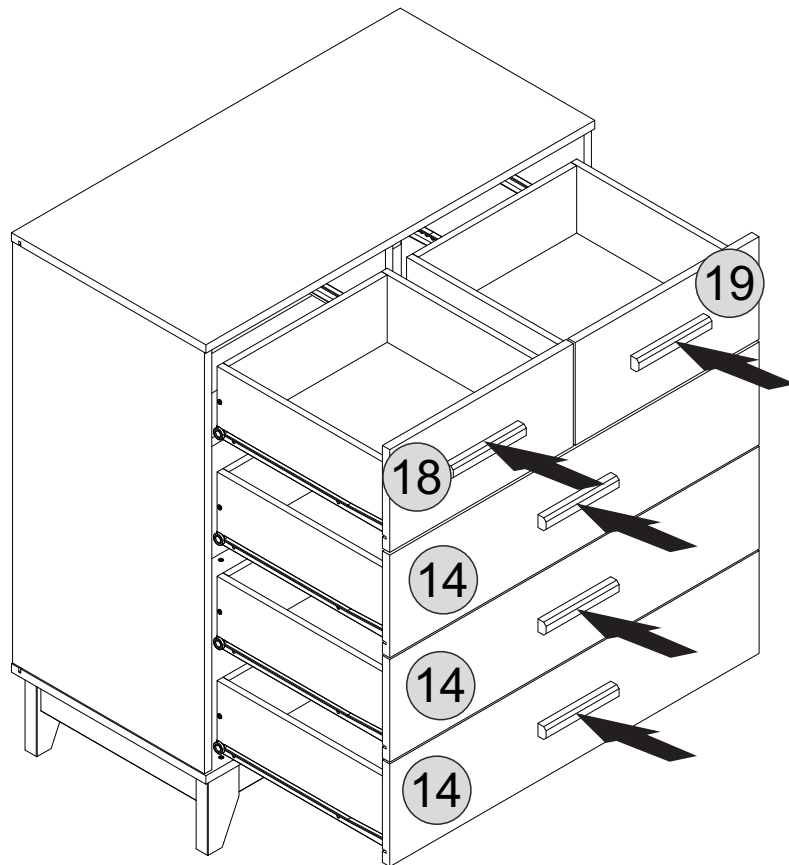

# STEP 33

**PARTS REQUIRED**

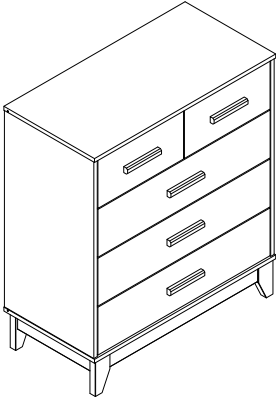

**HARDWARE REQUIRED**

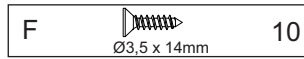

**TOOLS REQUIRED**

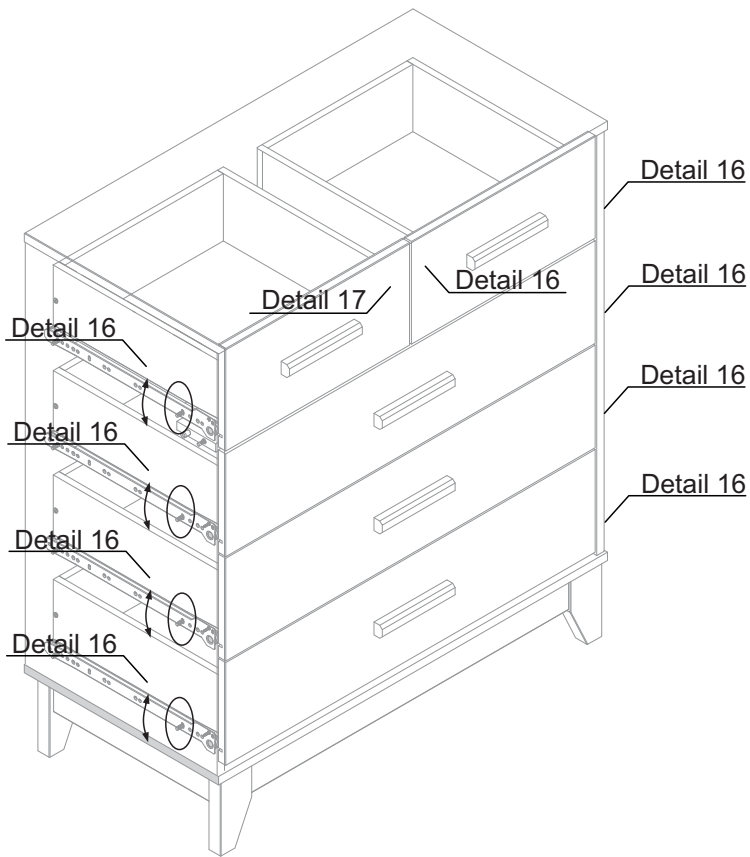
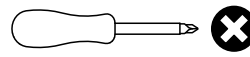

**Drawer Adjustment**

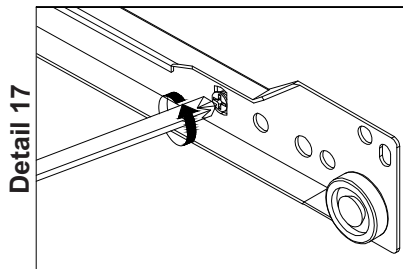

**Drawer Adjustment**

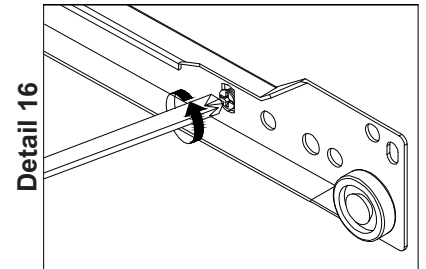

**Drawer Lock**

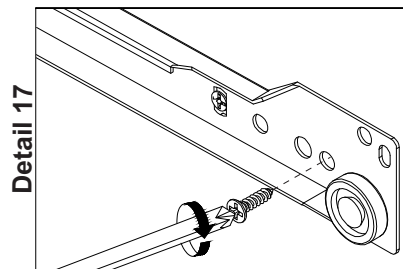

**Drawer Lock**

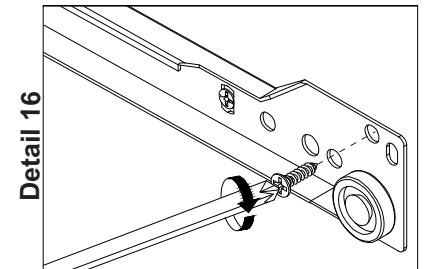

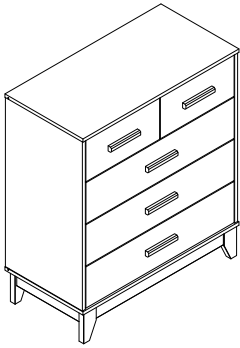

# STEP 34

## PARTS REQUIRED



## HARDWARE REQUIRED

D	 Ø3,5 x 25mm	01
O		02
R		01

## TOOLS REQUIRED

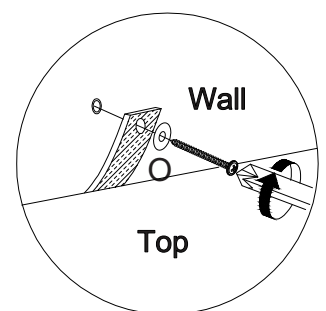
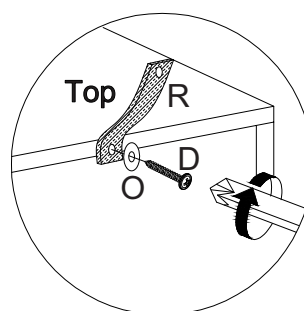
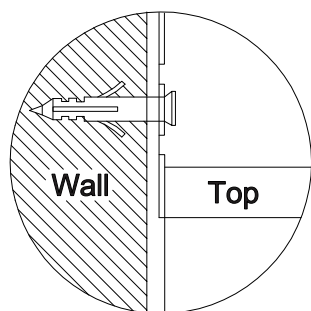
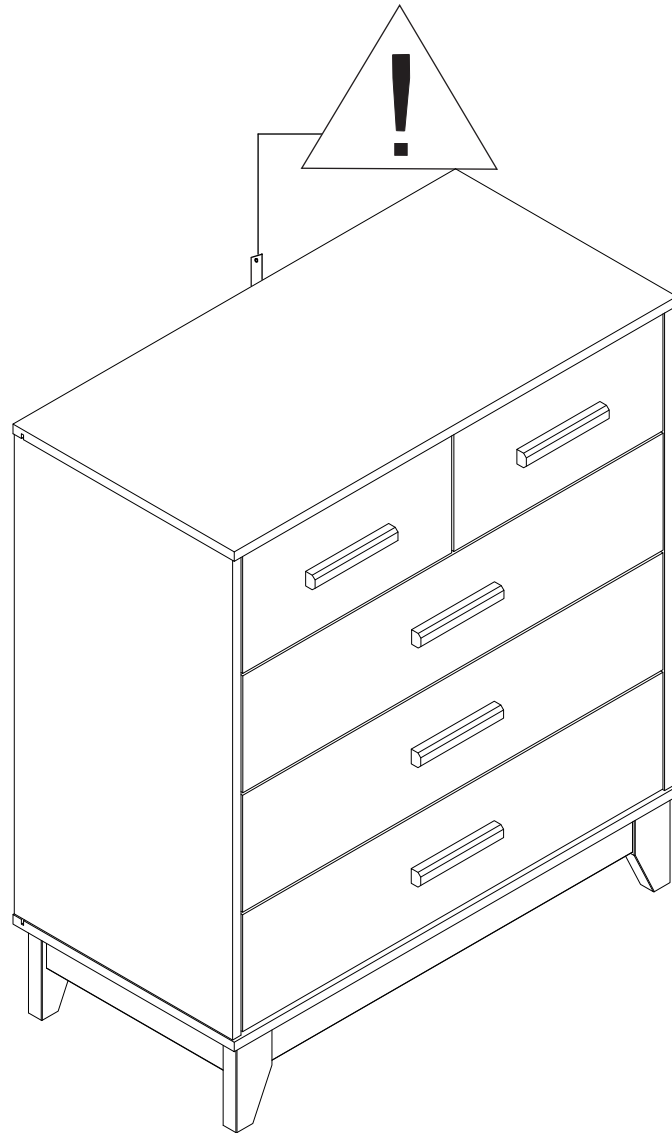
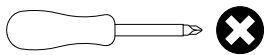

## WARNING

**Serious or fatal injuries can occur from furniture tipping over. To prevent the furniture from tipping over we recommend that it is permanently fixed to the wall.**

Wall fixings are not supplied with this product as different wall materials require different types of fixing devices. Please make sure you use fixings suitable for the walls in your home.