

CLEVELAND 3 DRAWER CHEST ASSEMBLY INSTRUCTIONS WHITE/GREY METAL EFFECT



IMPORTANT FOR DOMESTIC USE ONLY

PLEASE READ BEFORE YOU CONTINUE FURTHER

CARE AND MAINTENANCE

After unpacking this product please keep the original packaging in case it needs to be returned for any reason.

- Please ensure all fittings and parts are present before commencing with assembly.
- Never drag or push products as this could cause damage to the joints making it inferior.
- We strongly recommend that you keep children away from your work area.
- We recommend that you lay a blanket or sheet on the floor to avoid damage to both your floor and the product.
- Assemble this product as close to its final position as possible.
- Do not place this product next to a radiator or in direct sunlight.
- Do not drag or push items across your high gloss furniture as this may cause the surface to scratch
- Wood is a natural product and may expand if subjected to damp and may shrink or crack if subjected to heat. Therefore it is recommended that room temperature is maintained, with no sudden temperature fluctuations.
- Make sure any spillage is wiped off immediately.
- Do not place hot or chilled items directly on to the surface, use a place mat or marking will occur.
- For general cleaning use a soft cotton or micro fibre cloth, and do not use detergents of any kind.
- From time to time it may be necessary to tighten fittings, regular inspections should be carried out.
- Do not place on a wet or damp floor as staining may occur to your floor.

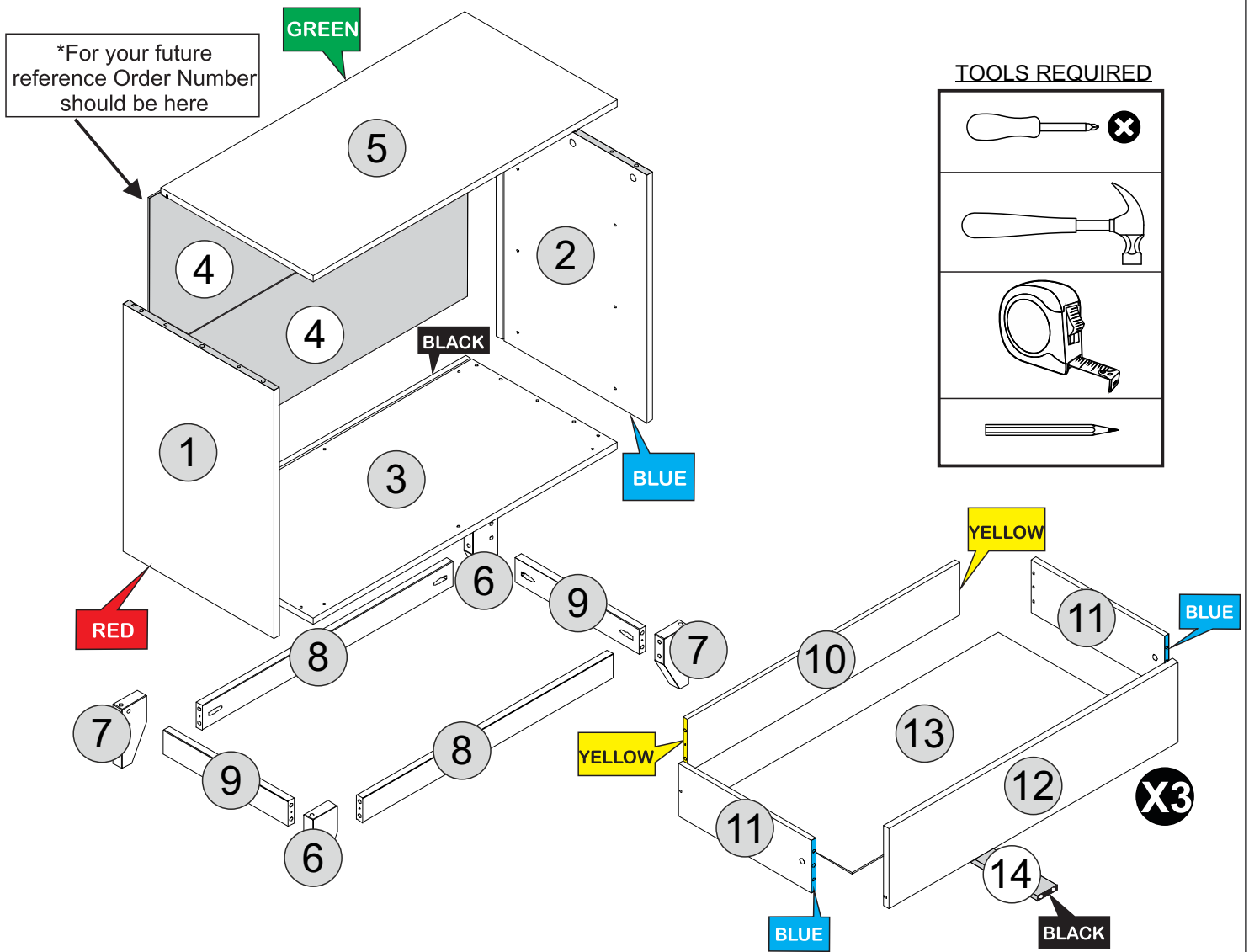





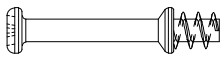
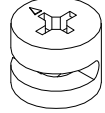
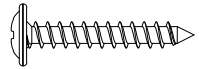
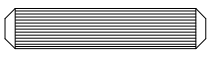
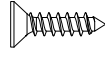

PARTS LIST

Please Note:
The below parts have all been stamped with the part number/color to help identify them during assembly.

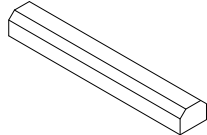
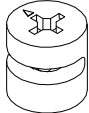
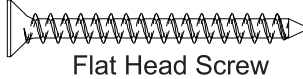
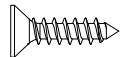
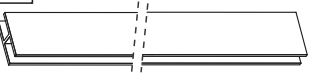
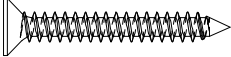
Part Number	Part Code	Part Description	Quantity	Carton
1	S100-102-191-SP1-01	Left Side Panel - RED	1	1/1
2	S100-102-191-SP1-02	Right Side Panel - BLUE	1	1/1
3	S100-102-191-SP1-03	Base Panel - BLACK	1	1/1
4	S100-102-191-SP1-04	Back Panel	2	1/1
5	S100-102-191-SP1-05	Top Panel - GREEN	1	1/1
6	S100-102-191-SP1-06	Left Leg	2	1/1
7	S100-102-191-SP1-07	Right Leg	2	1/1
8	S100-102-191-SP1-08	Leg Support Front & Back	2	1/1
9	S100-102-191-SP1-09	Leg Support Left & Right	2	1/1
10	S100-102-191-SP1-10	Drawer Back - YELLOW	3	1/1
11	S100-102-191-SP1-11	Drawer Sides - BLUE	6	1/1
12	S100-102-191-SP1-12	Drawer Front	3	1/1
13	S100-102-191-SP1-13	Drawer Base	3	1/1
14	S100-102-191-SP1-14	Drawer Base Support - BLACK	3	1/1

FITTINGS LIST

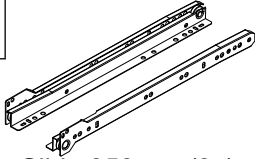
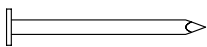
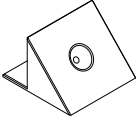
<p>A</p>  <p>2/+ Dowel Ø8,0 x 30mm (20x)</p>	<p>B</p>  <p>2/+ Cam Bolt (12x)</p>	<p>C</p>  <p>1/+ Cam Nut 15mm (6x)</p>	<p>D</p>  <p>2/+ Flan Head Screw Ø3,5 x 25mm (10x)</p>
<p>E</p>  <p>2/+ Dowel Ø6,0 x 30mm (38x)</p>	<p>F</p>  <p>2/+ Flat Head Screw Ø3,5 x 14mm (18x)</p>	<p>G</p>  <p>1/+ Pan Head Screw Ø4,0 x 35mm (8x)</p>	<p>H</p>  <p>2/+ Screw Ø 6x10 (12x)</p>
<p>I</p>  <p>Handle(3x)</p>	<p>J</p>  <p>1/+ Cam Nut 12mm (6x)</p>	<p>K</p>  <p>2/+ Flat Head Screw Ø4,0 x 50mm (12x)</p>	<p>L</p>  <p>2/+ Flat Head Screw Ø3,5 x 16mm (16x)</p>
<p>M</p>  <p>Back Panel Strip 765mm (1x)</p>	<p>N</p>  <p>1/+ Flat Head Screw Ø4,0 x 40mm (6x)</p>	<p>O</p>  <p>1/+ Washer (2x)</p>	<p>P</p>  <p>2/+ Hole Plugs (12x)</p>
<p>Q</p>  <p>Glue (3x)</p>	<p>R</p>  <p>Strap (1x)</p>	<p>S</p>  <p>Slide 350mm (3x)</p>	<p>T</p>  <p>2/+ Nail 10 x 10 (12x)</p>
<p>U</p>  <p>2/+ Plastic Corner Bracket (16x)</p>			

TIPS FOR FITTINGS CAM-LOCKS

WHEN FITTING CAM NUT. ENSURE STARTING POSITION IS CORRECT BEFORE YOU INSERT CONNECTING CAM BOLT TURN CLOCKWISE UNTIL SECURE



↑

CORRECT



↑

WRONG

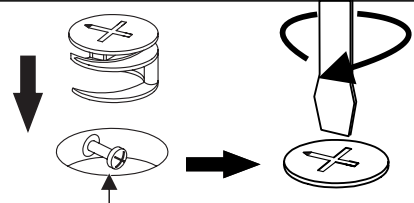

Cam bolt head needs to be in centre

CAMBOLT
Tighten until shoulder is flush with panel. Do not overtighten or undertighten (see example beside)

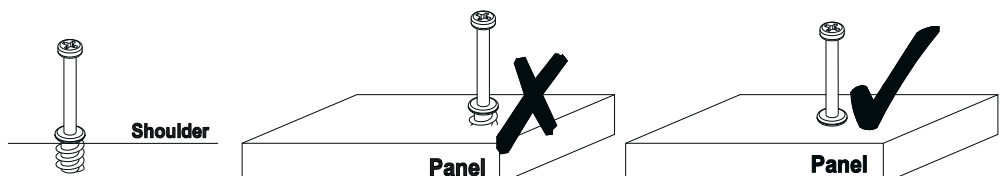

STEP 1

PARTS REQUIRED

1 - LEFT SIDE PANEL (RED) x1

HARDWARE REQUIRED

E  04
Ø6,0 x 30mm

Q  01
GLUE

TOOLS REQUIRED

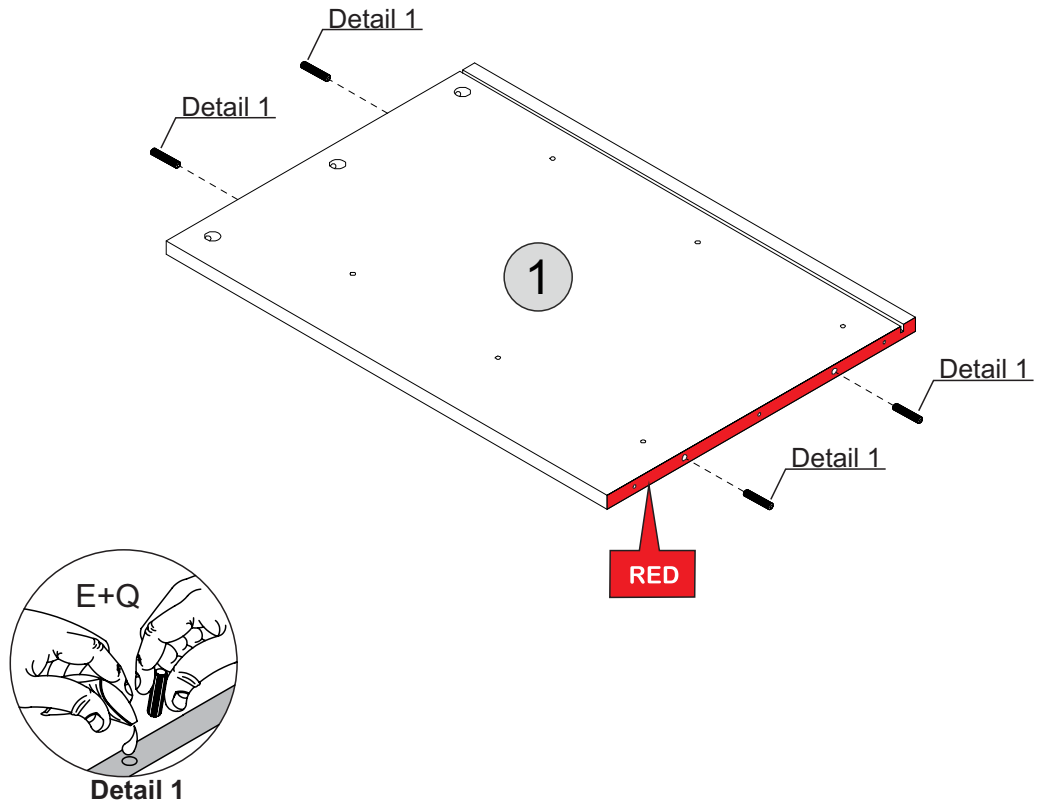
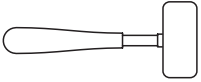

STEP 2

PARTS REQUIRED

1- LEFT SIDE PANEL (RED) x1

HARDWARE REQUIRED

H  06
Ø6x10mm

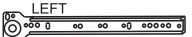
S  03
LEFT

TOOLS REQUIRED

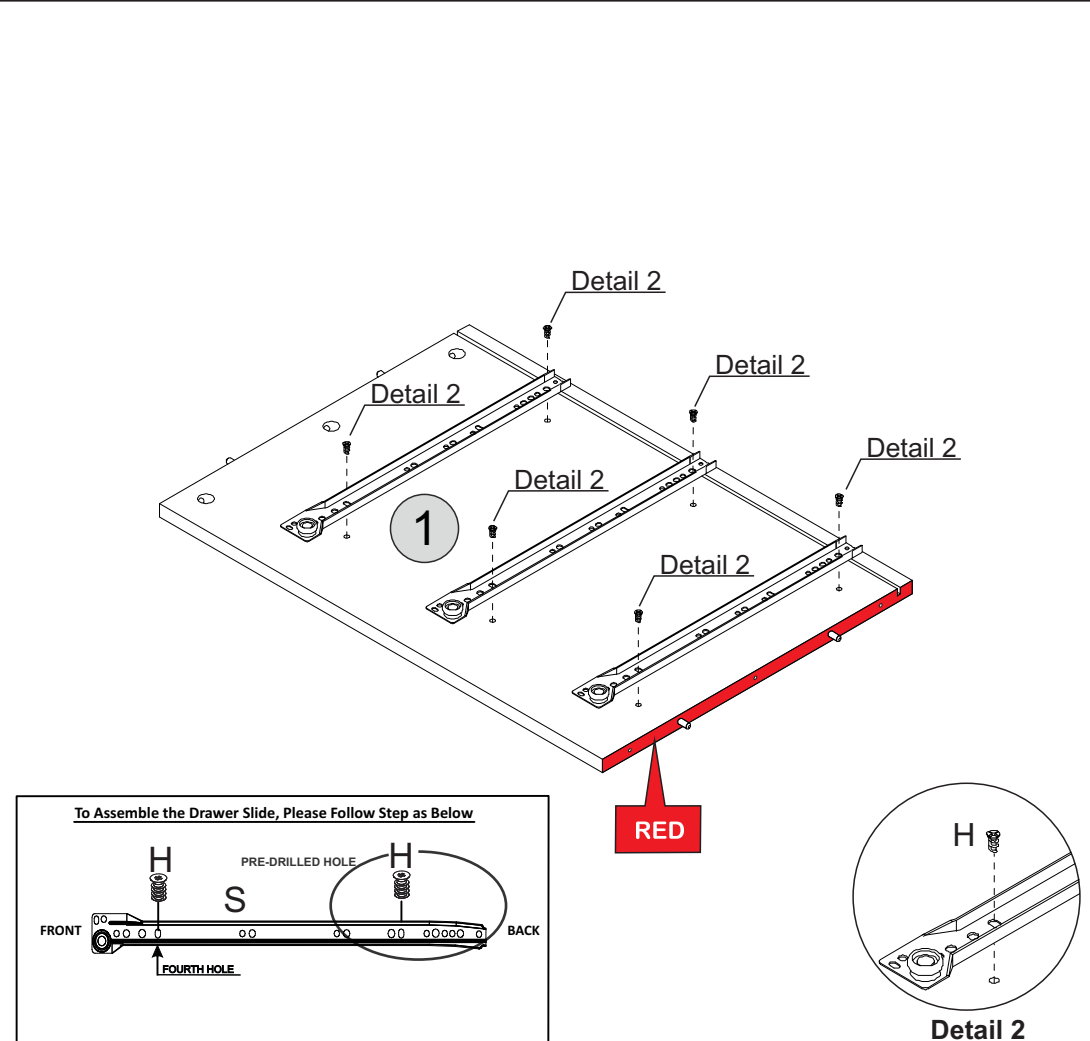
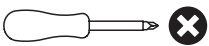

STEP 3

PARTS REQUIRED

2 - RIGHT SIDE PANEL (BLUE) x1

HARDWARE REQUIRED

E  04
Ø6,0 x 30mm

Q  01

TOOLS REQUIRED

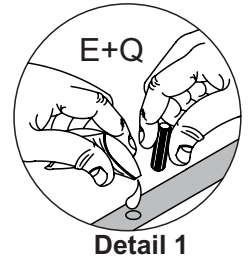
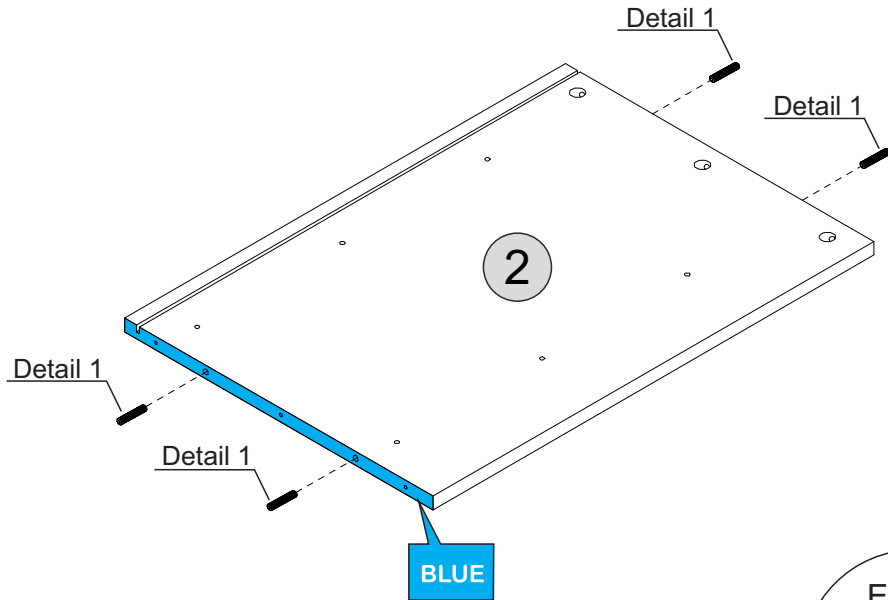
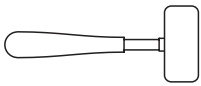

STEP 4

PARTS REQUIRED

2 - RIGHT SIDE PANEL (BLUE) x1

HARDWARE REQUIRED

H  06
Ø6x10mm

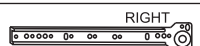
S  RIGHT 03

TOOLS REQUIRED

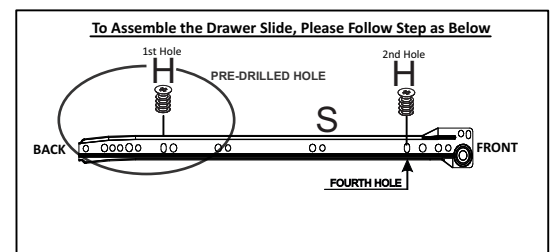
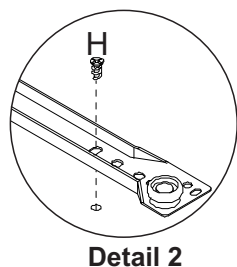
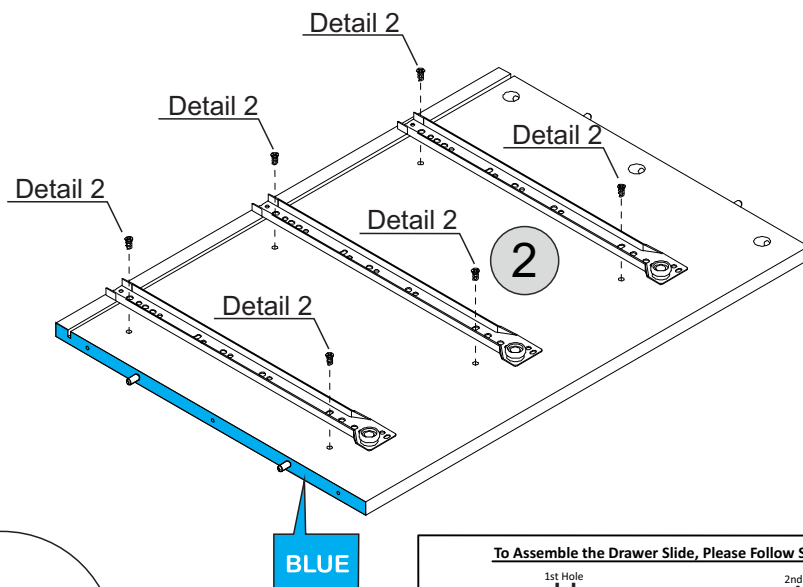
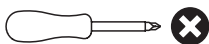

STEP 5

PARTS REQUIRED

5 - TOP PANEL (GREEN) x1

HARDWARE REQUIRED

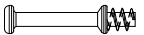
B  06

TOOLS REQUIRED

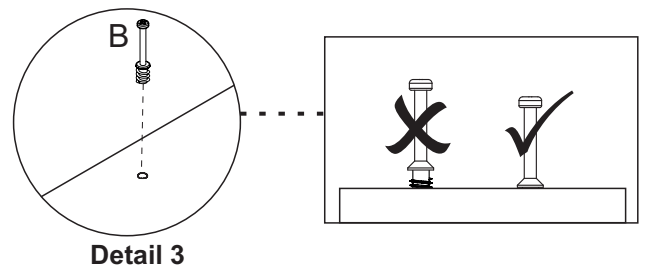
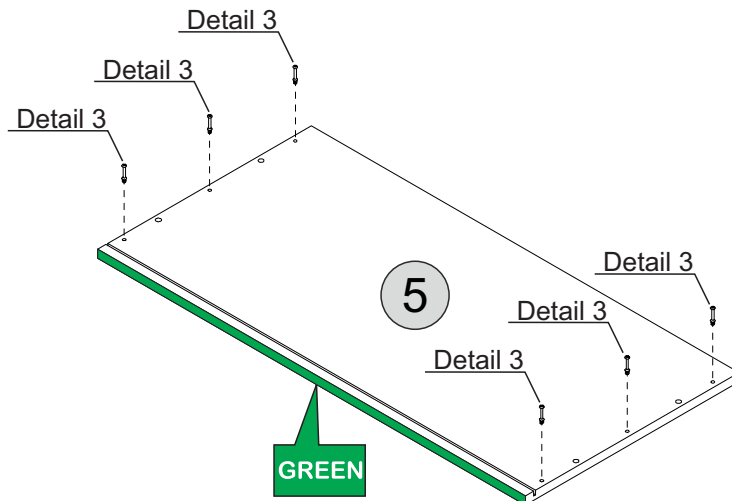

STEP 6

PARTS REQUIRED

1 - LEFT SIDE PANEL (RED) x1

2 - RIGHT SIDE PANEL (BLUE) x1

3 - BASE PANEL (BLACK) x1

HARDWARE REQUIRED

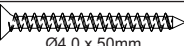
K  06
Ø4.0 x 50mm

Q  01
GLUE

TOOLS REQUIRED

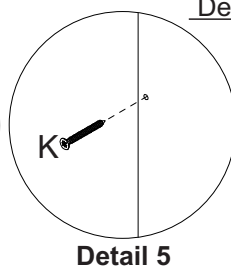
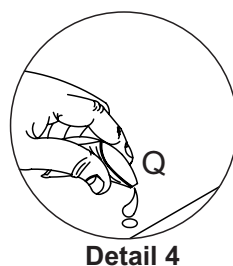
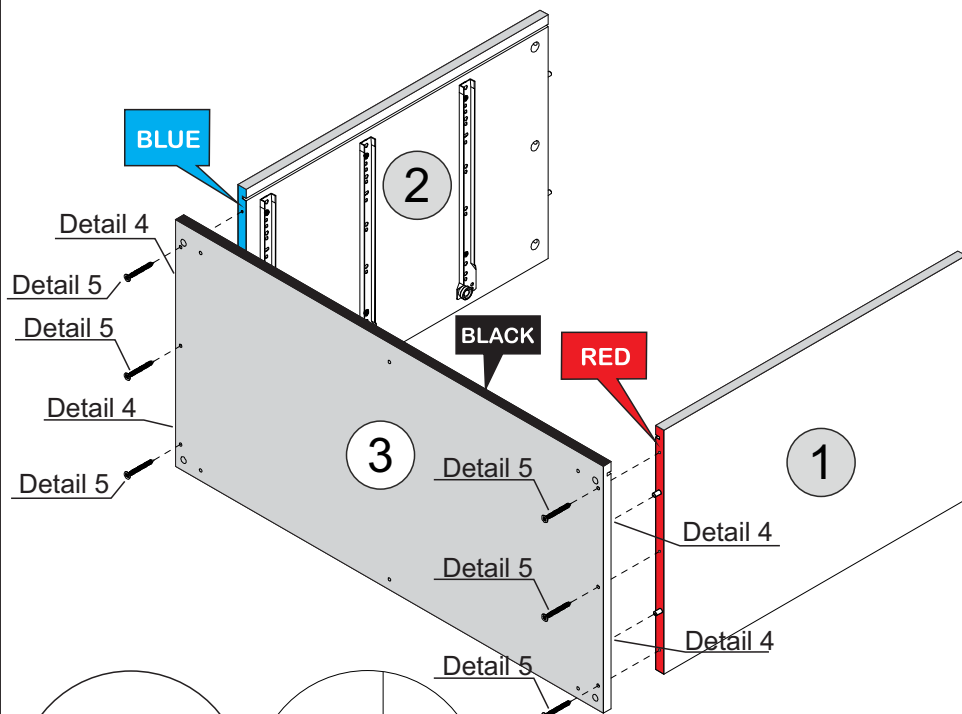

STEP 7

PARTS REQUIRED

4- BACK PANEL x2

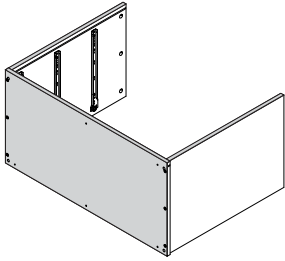

HARDWARE REQUIRED

M 01

TOOLS REQUIRED

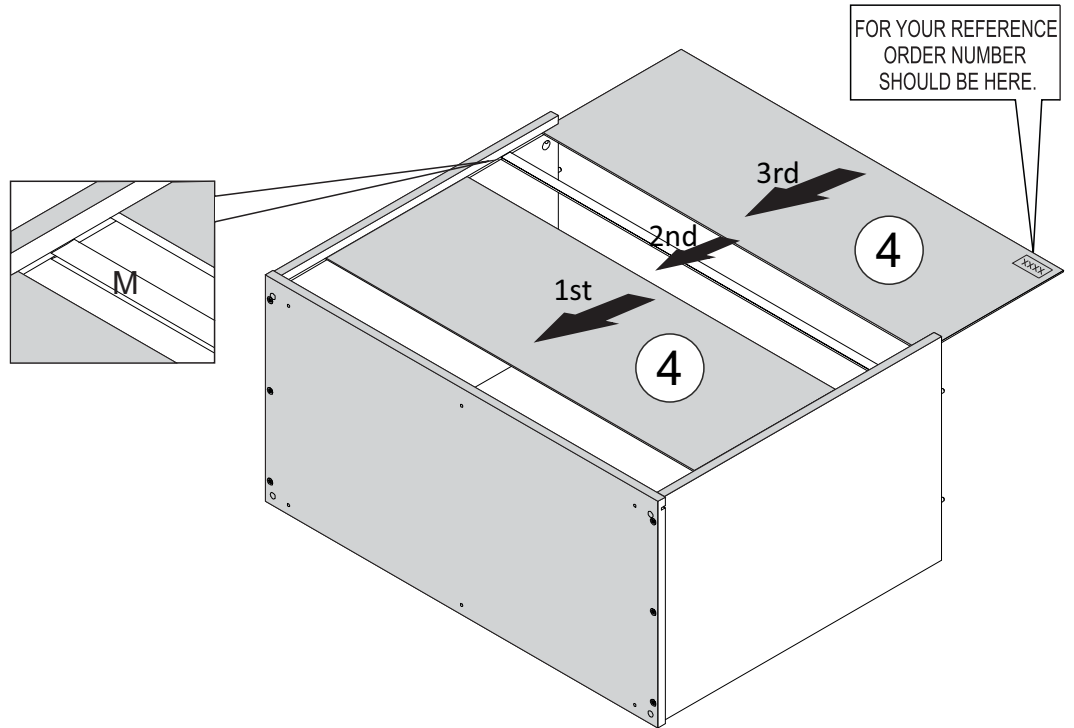
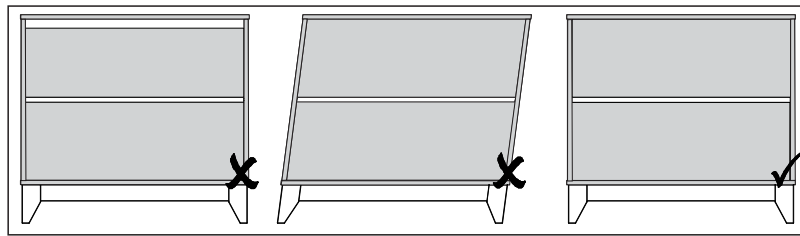

STEP 8

PARTS REQUIRED

5 - TOP PANEL (GREEN) x1

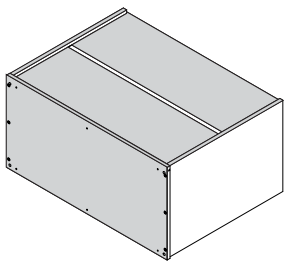

HARDWARE REQUIRED

C Ø15mm 06

Q 01

TOOLS REQUIRED

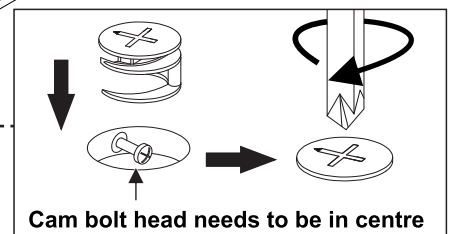
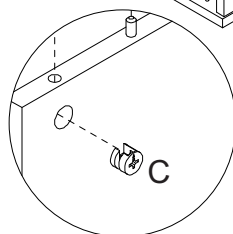
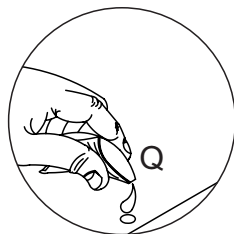
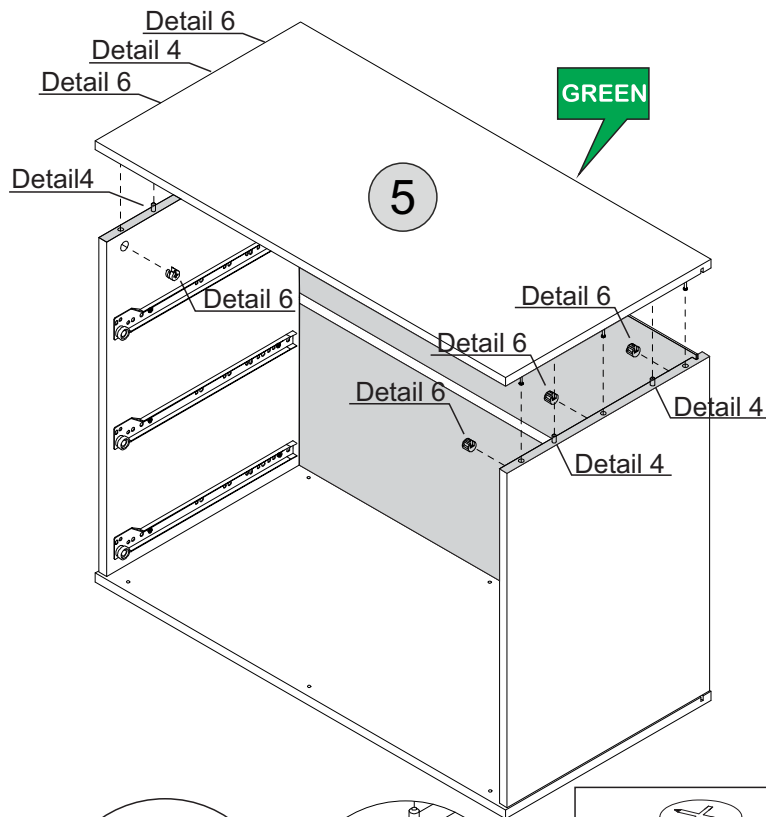

Detail 4



Detail 6

STEP 9

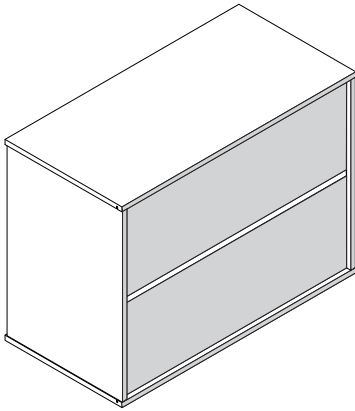
PARTS REQUIRED



HARDWARE REQUIRED

L	 Ø3.5 x 16mm	16
U		16

TOOLS REQUIRED

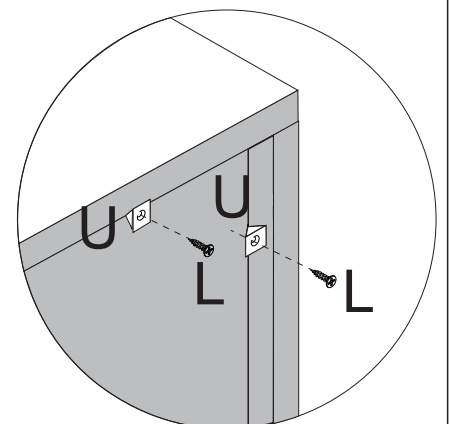
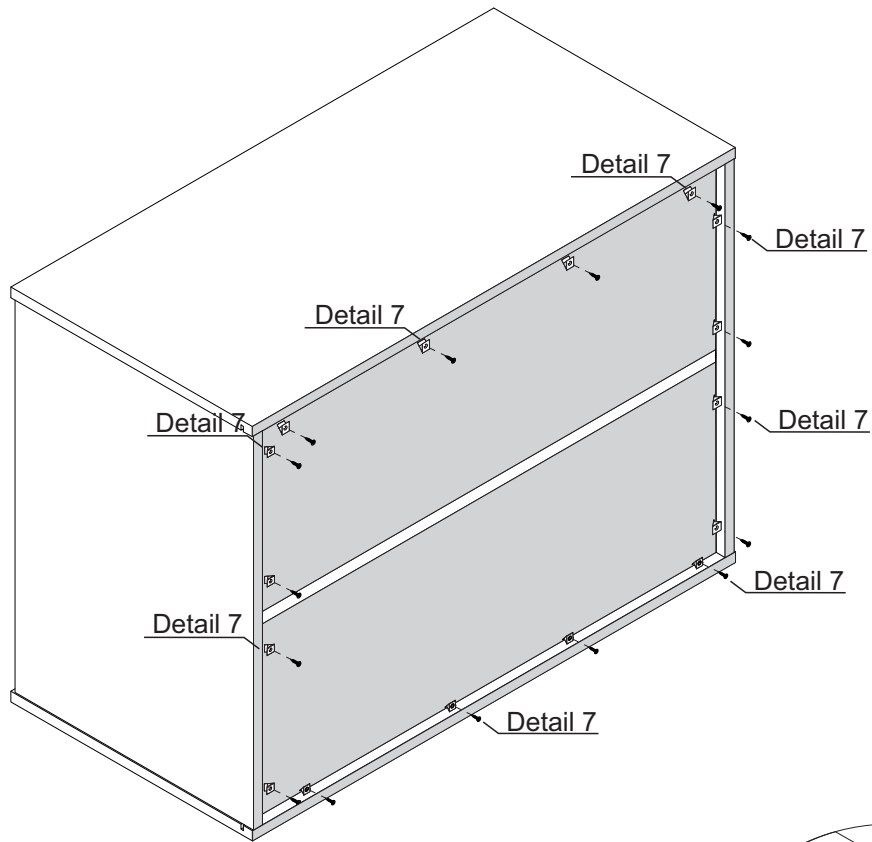

Detail 7

STEP 10

PARTS REQUIRED

6 - LEFT LEG x2

7 - RIGHT LEG x2

HARDWARE REQUIRED

A  20
Ø8,0 x 30mm

Q  01
GLUE

TOOLS REQUIRED

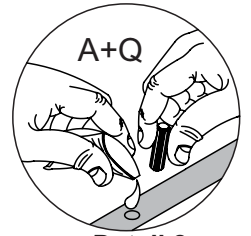
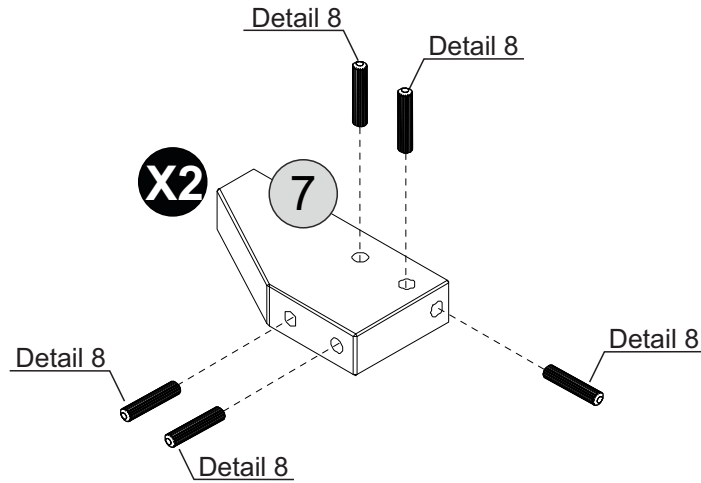
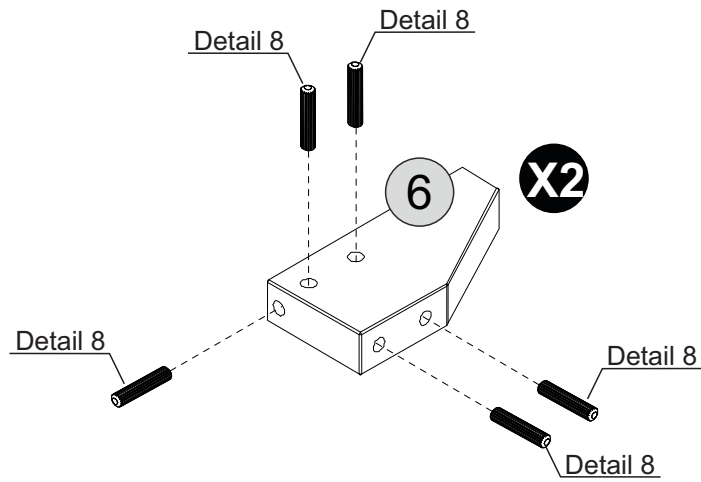
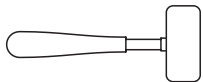

Detail 8

STEP 11

PARTS REQUIRED

6 - LEFT LEG x2

7 - RIGHT LEG x2

8- LEG SUPPORT FRONT&BACK x2

HARDWARE REQUIRED

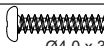
G  04
Ø4,0 x 35mm

Q  01
GLUE

TOOLS REQUIRED

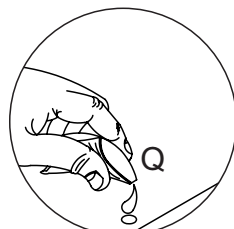
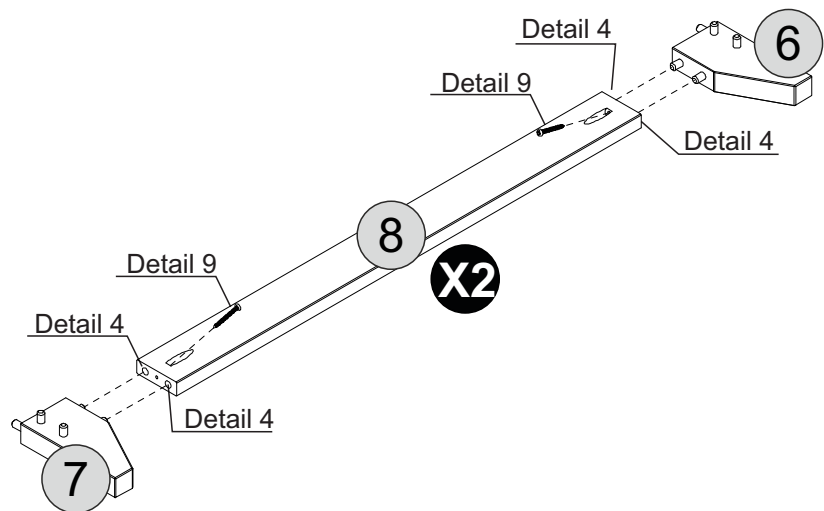

Detail 4

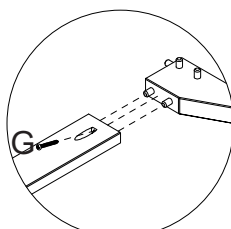

Detail 9

STEP 12

PARTS REQUIRED

9 - LEG SUPPORT LEFT & RIGHT x2

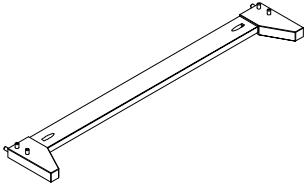

HARDWARE REQUIRED

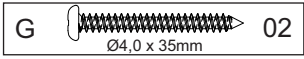

TOOLS REQUIRED

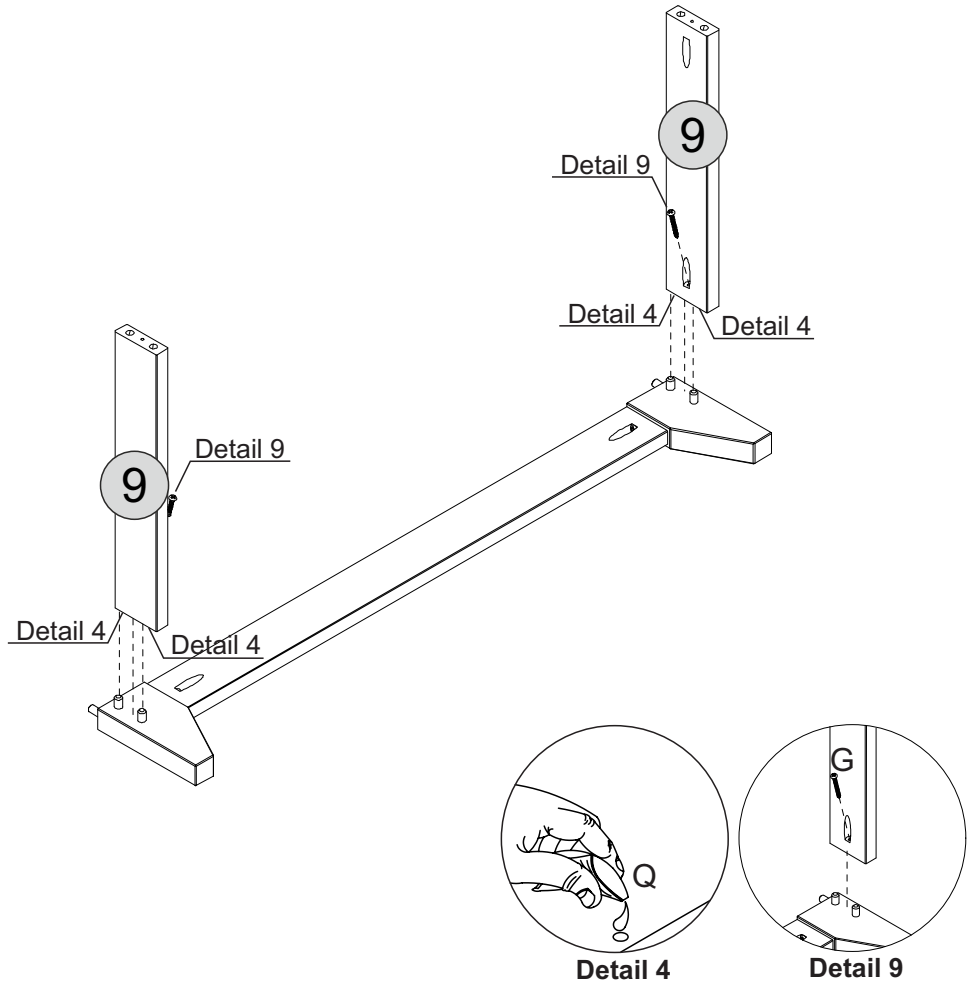
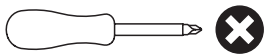

STEP 13

PARTS REQUIRED

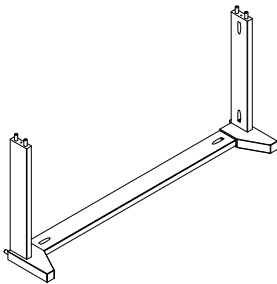

HARDWARE REQUIRED

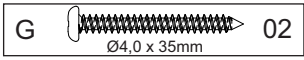

TOOLS REQUIRED

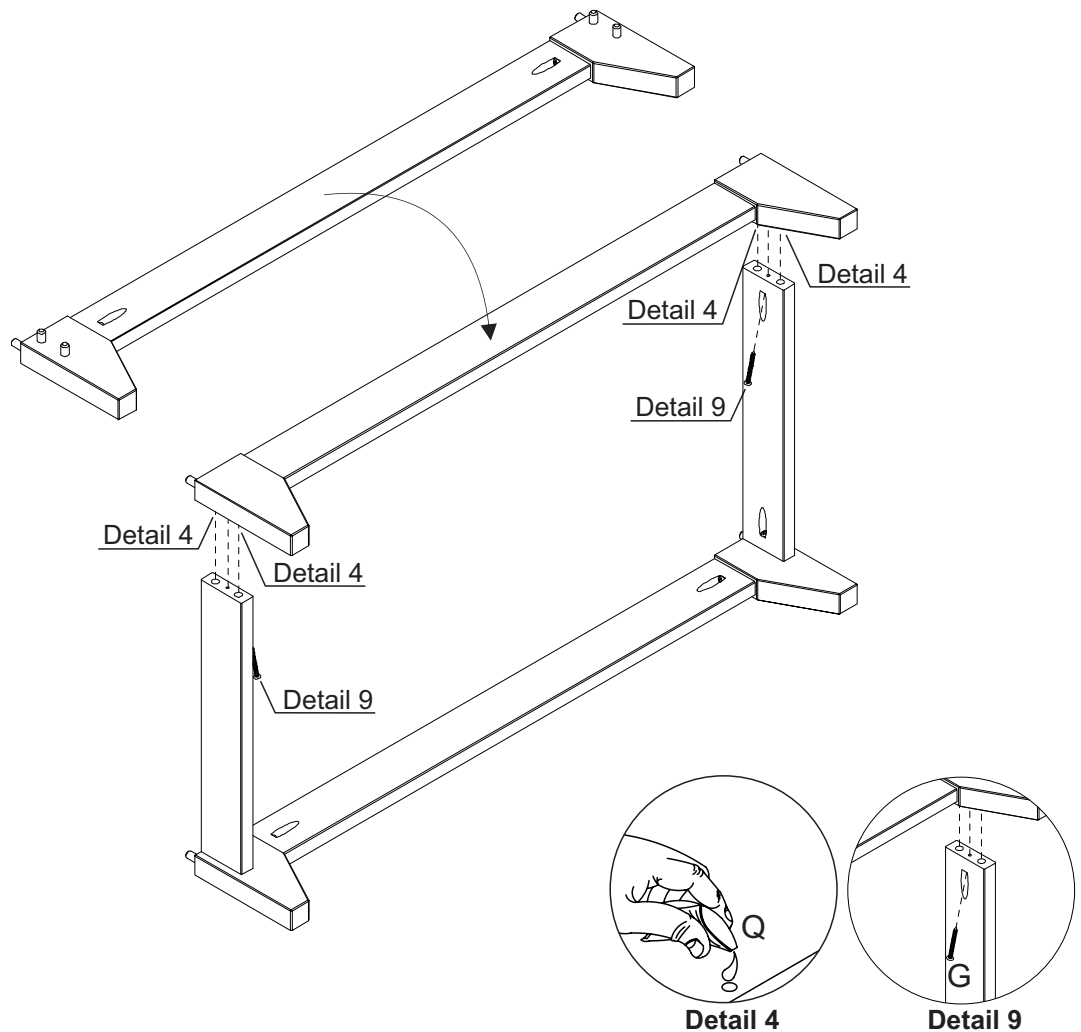
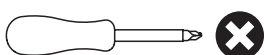

STEP 14

PARTS REQUIRED

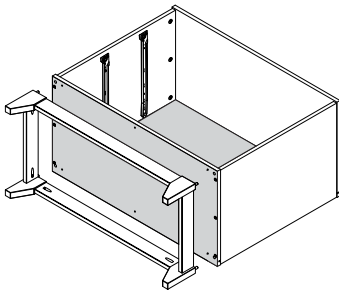

HARDWARE REQUIRED

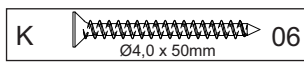

TOOLS REQUIRED

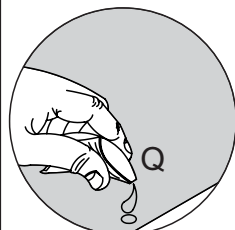
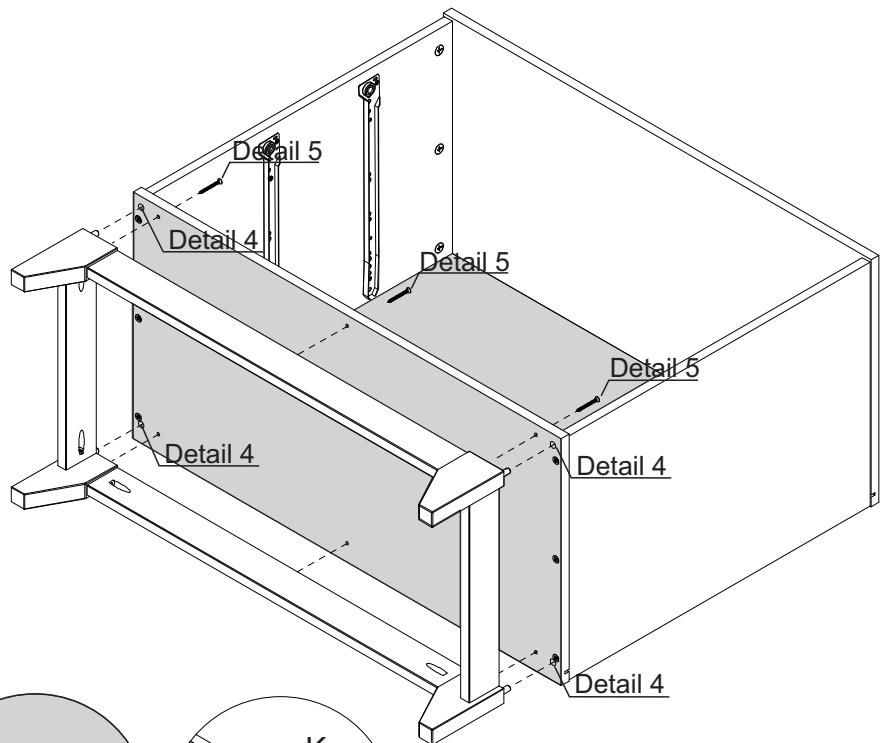
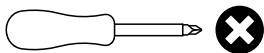

Detail 4

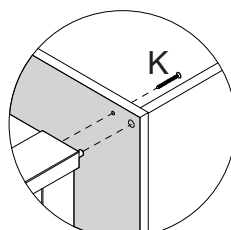

Detail 5

STEP 15

PARTS REQUIRED

10 - DRAWER BACK (YELLOW) x3

11 - DRAWER SIDES (BLUE) x6

14 - DRAWER BASE SUPPORT (BLACK) x3

HARDWARE REQUIRED

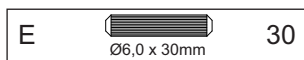

TOOLS REQUIRED

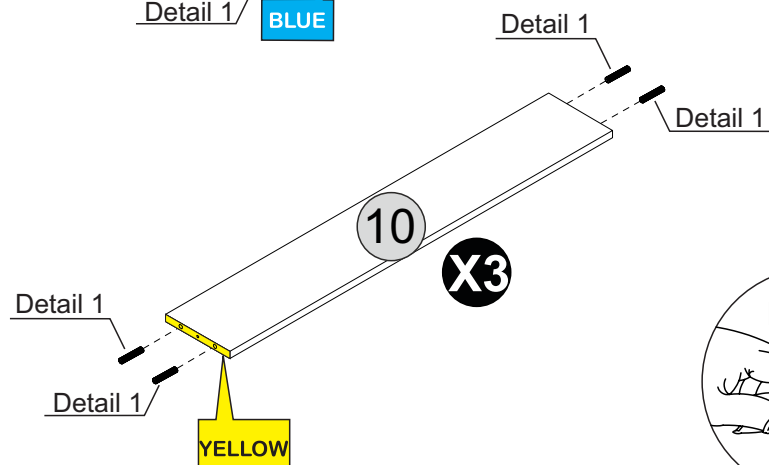
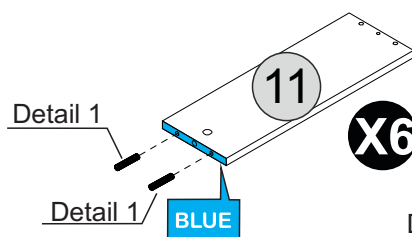
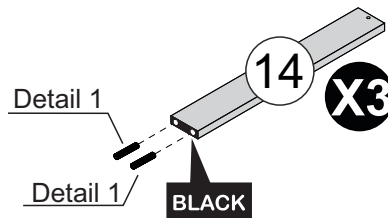
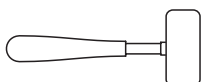

Detail 1

STEP 16

PARTS REQUIRED

12 - DRAWER FRONT x3

HARDWARE REQUIRED

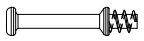
B  06

TOOLS REQUIRED

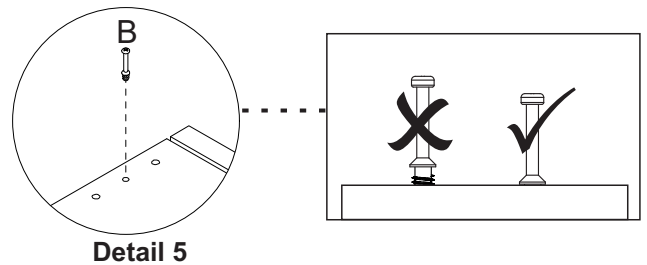
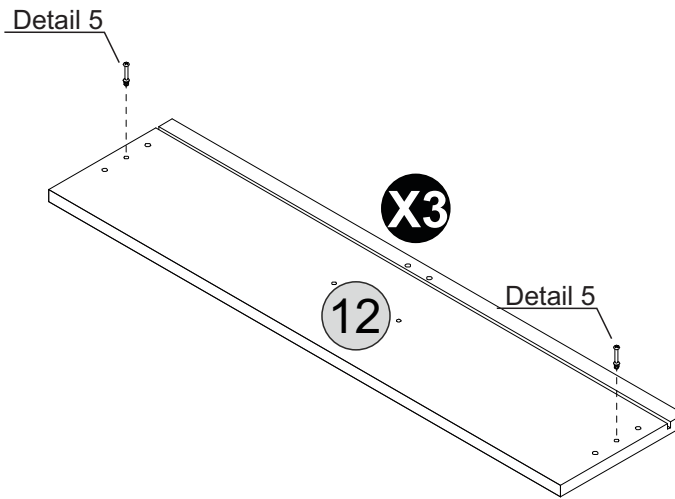
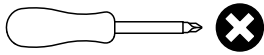

STEP 17

PARTS REQUIRED

10- DRAWER BACK (YELLOW) x3

11 - DRAWER SIDES (BLUE) x6

HARDWARE REQUIRED

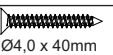
N  Ø4,0 x 40mm 06

Q  01

TOOLS REQUIRED

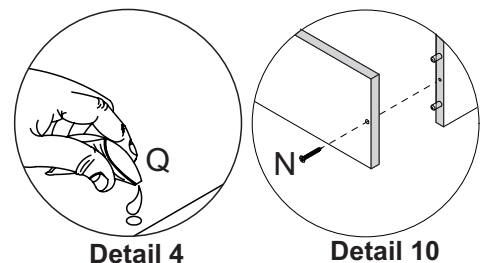
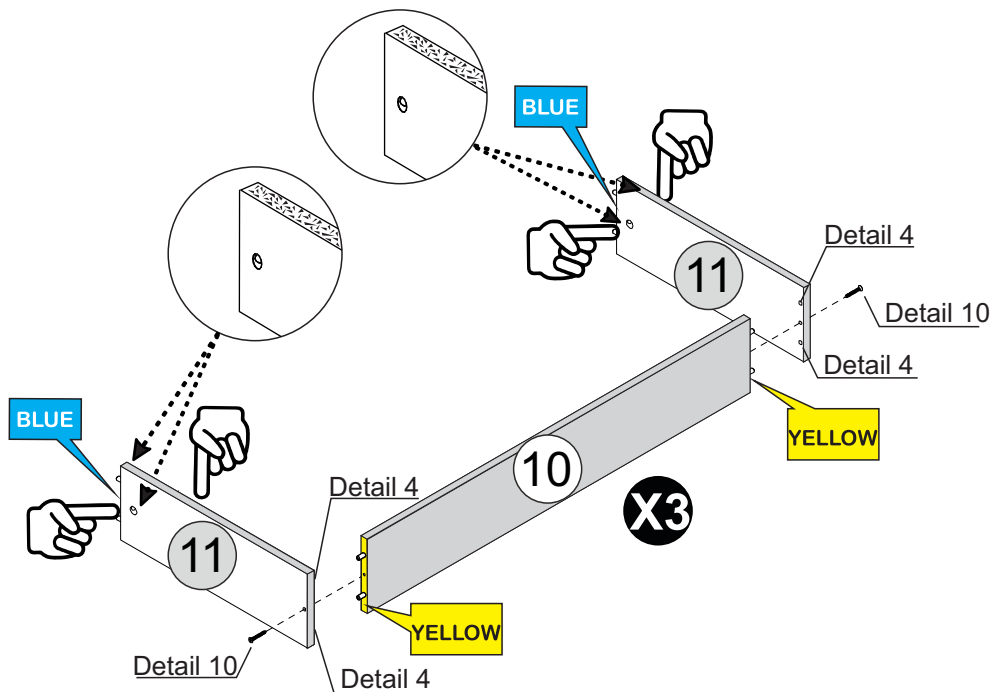
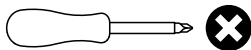

STEP 18

PARTS REQUIRED

12 - DRAWER FRONT x3

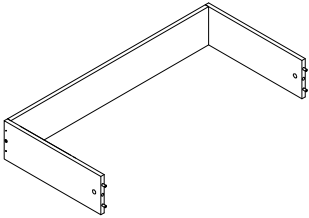

HARDWARE REQUIRED

J  Ø12mm 06

Q  GLUE 01

TOOLS REQUIRED

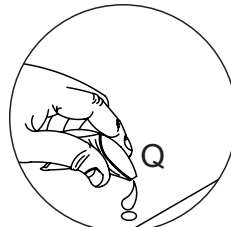
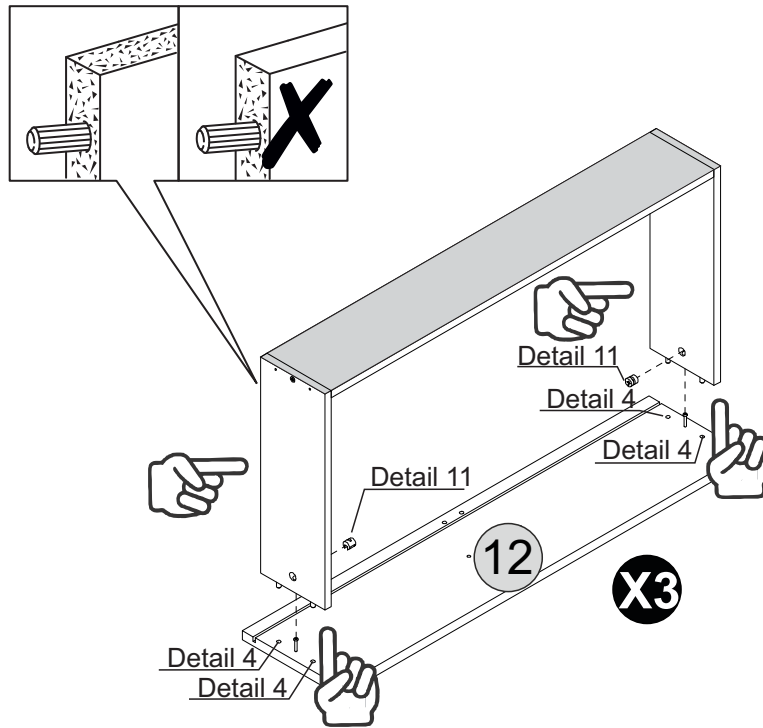
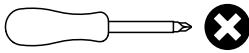

Detail 4

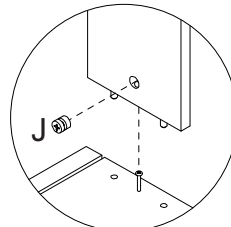

Detail 11

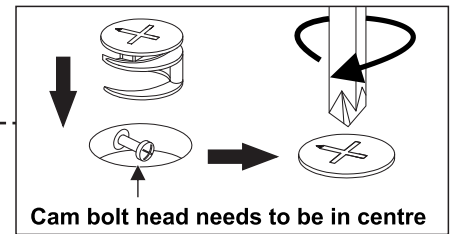

Cam bolt head needs to be in centre

STEP 19

PARTS REQUIRED

13 - DRAWER BASE x3

14 - DRAWER BASE SUPPORT (BLACK) x3

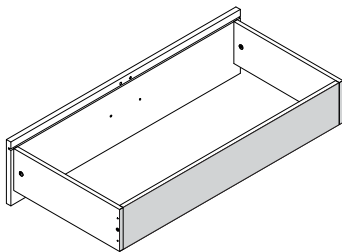

HARDWARE REQUIRED

Q  GLUE 01

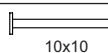
T  10x10 12

TOOLS REQUIRED

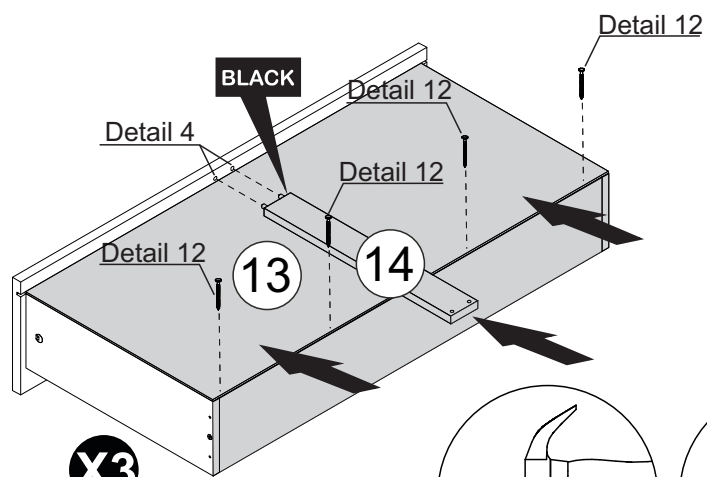
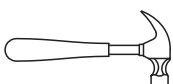

X3

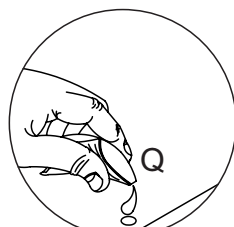

Detail 4

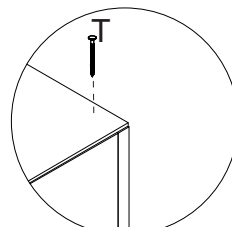

Detail 12

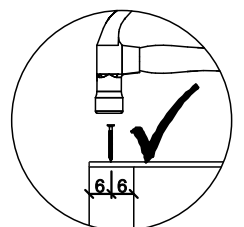
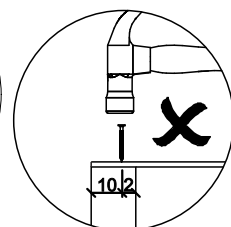
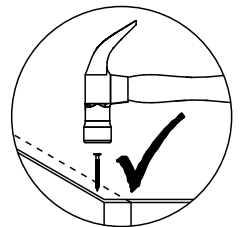
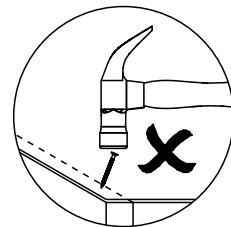



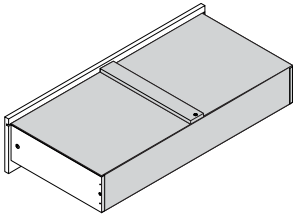

STEP 20

PARTS REQUIRED

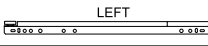

HARDWARE REQUIRED

D		03
F		12
S	LEFT 	03
S	RIGHT 	03

TOOLS REQUIRED

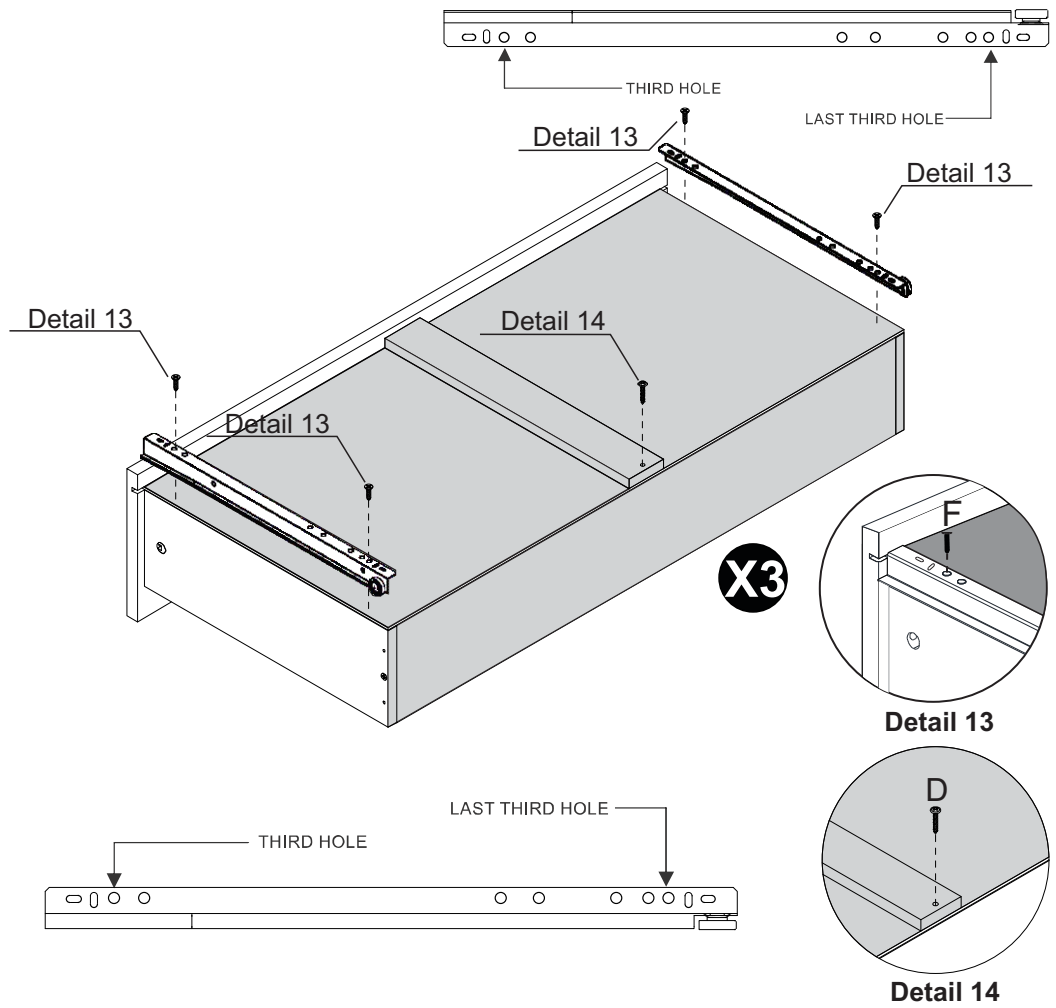
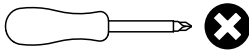

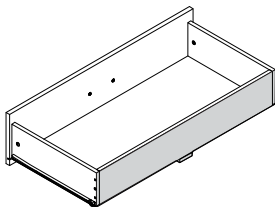

STEP 21

PARTS REQUIRED



HARDWARE REQUIRED

D		06
I		03
P		12

TOOLS REQUIRED

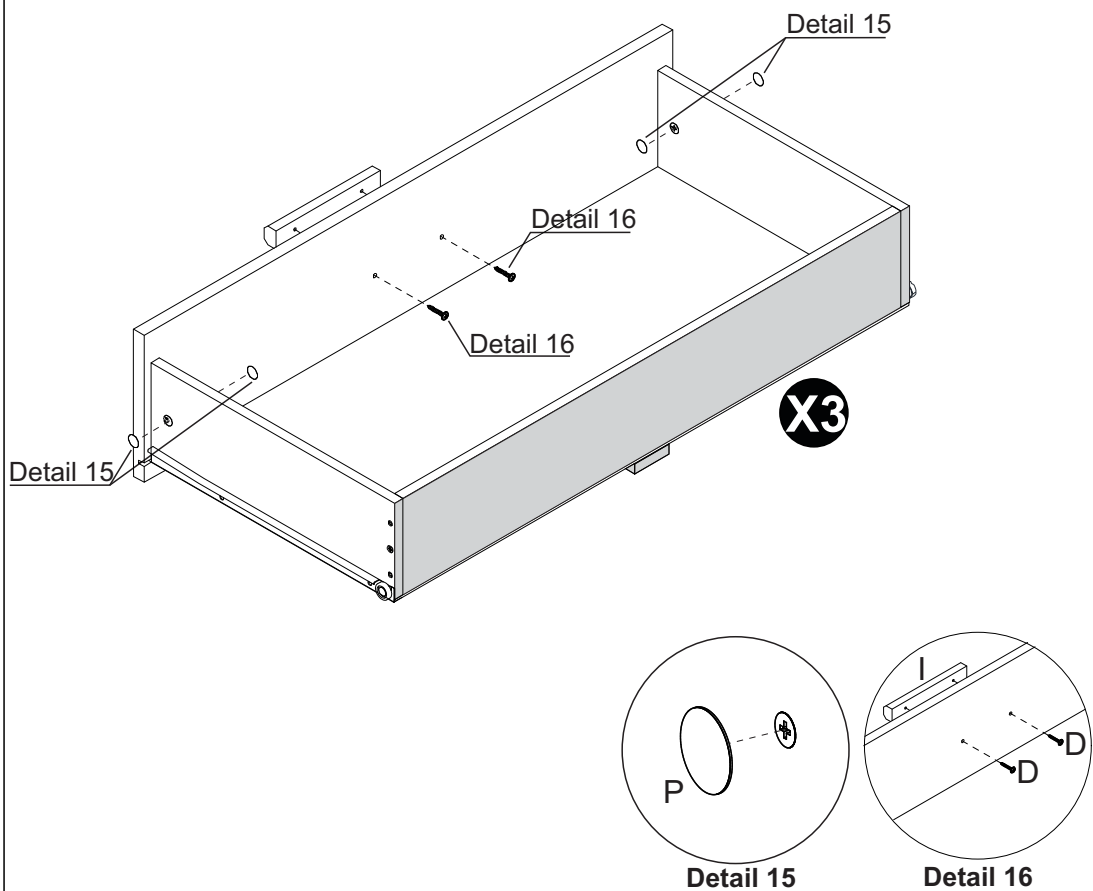

STEP 22

PARTS REQUIRED

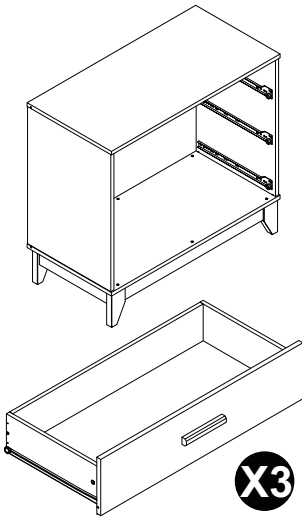

HARDWARE REQUIRED

TOOLS REQUIRED

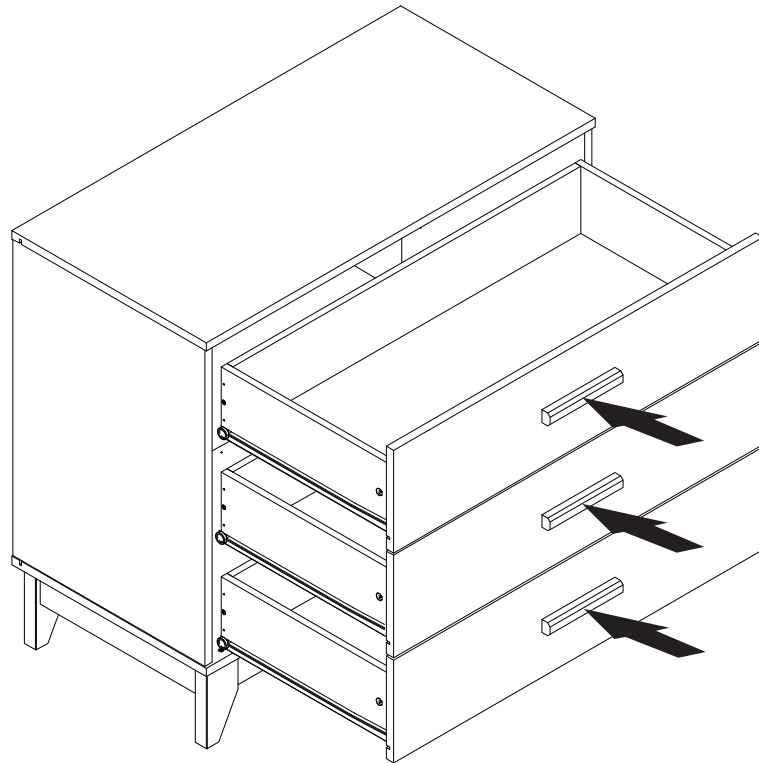

STEP 23

PARTS REQUIRED

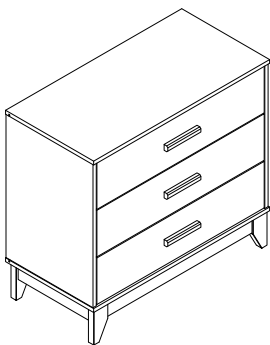

HARDWARE REQUIRED

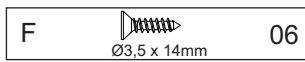

TOOLS REQUIRED

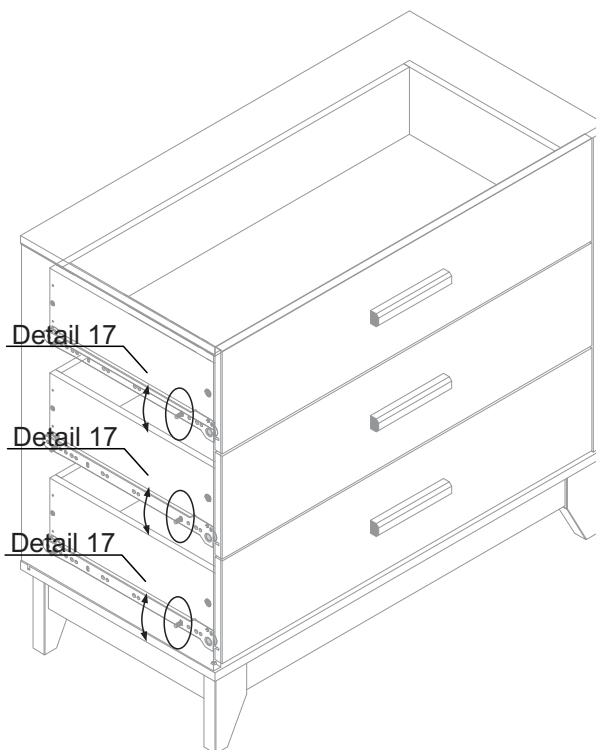
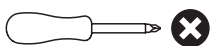

Drawer Adjustment

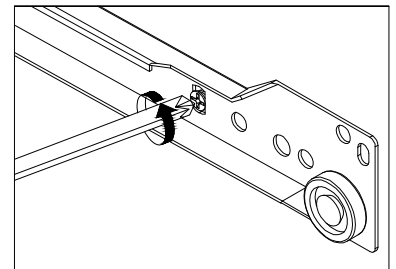

Drawer Lock

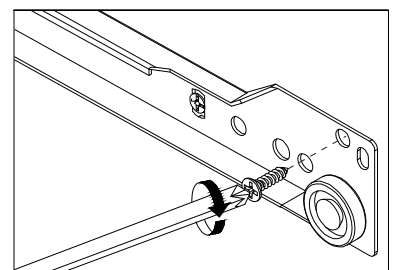

Detail 17

STEP 24

PARTS REQUIRED

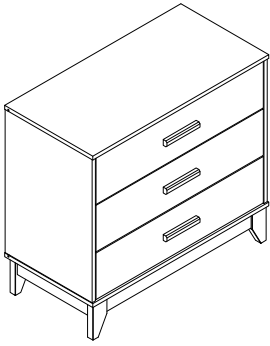

HARDWARE REQUIRED

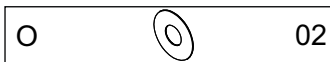
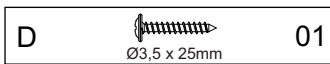

TOOLS REQUIRED

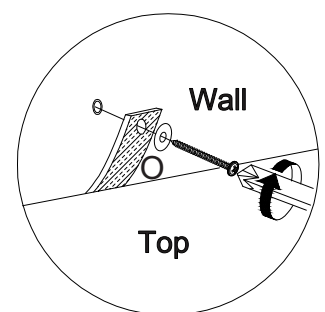
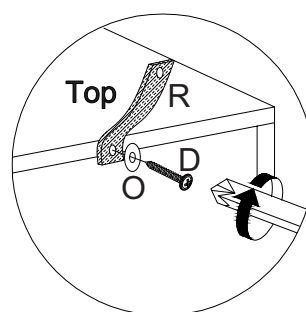
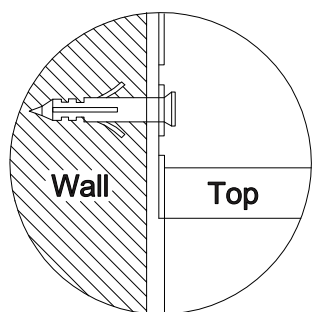
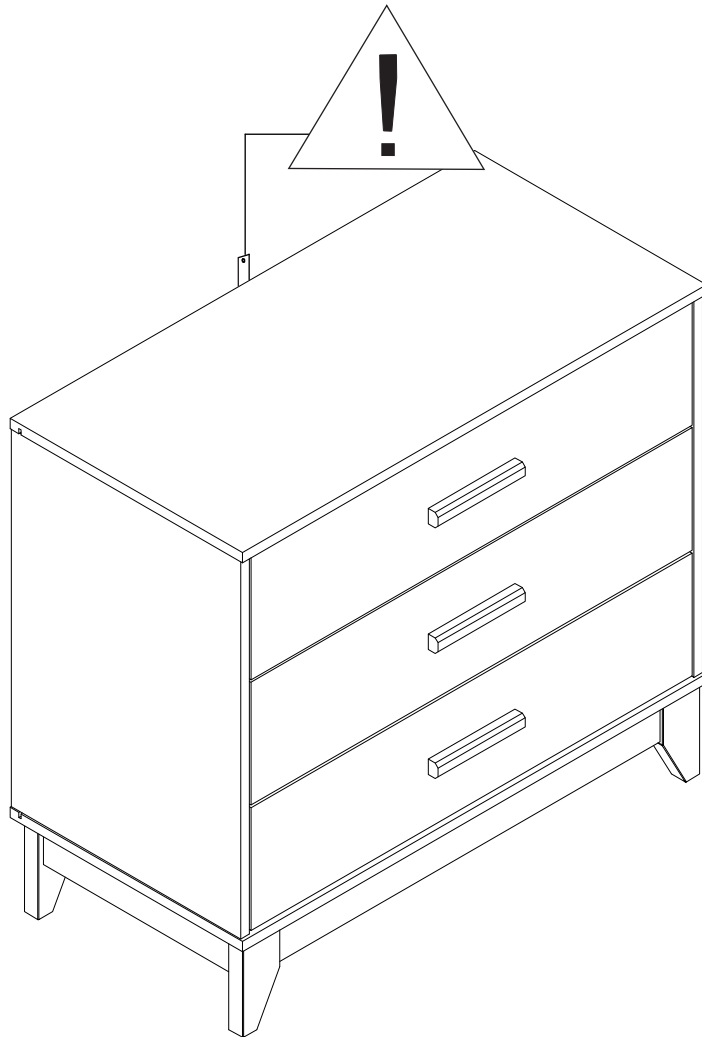
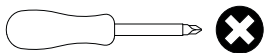

WARNING

Serious or fatal injuries can occur from furniture tipping over. To prevent the furniture from tipping over we recommend that it is permanently fixed to the wall.

Wall fixings are not supplied with this product as different wall materials require different types of fixing devices. Please make sure you use fixings suitable for the walls in your home.