

4'6" CHESTER BED

1. Please read through and follow the step by step instructions in the leaflet.
2. We recommend that assembly is done in the room intended for use it is assembled by two adults.
3. Please do not discard any packaging before you have checked all the parts and fittings are complete.
4. Assemble this product on a flat and clean surface to avoid scratching.
5. Do not fully tighten all bolts until all parts have been assembled loosely. Product and/or fittings might be damaged by over tightening screws or bolts. Beware of cross-threading the screws and nuts during assembly.
6. Keeps fittings away from children's reach.
7. Wipe clean using a soft damp cloth followed by a dry cloth.
8. Do not use abrasives or cleaning products which may contain ammonia or solvents.
9. Take care when handling or moving the furniture. Careless handling can damage wooden furniture, try to lift rather than drag.

SAFETY WARNING

Do not stand on the bed base without a mattress in place

PARTS LIST

(A) Headend

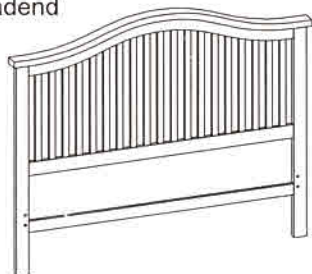

(B) Footend

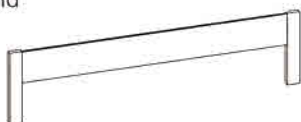

(C) Siderail x 2 pcs



(D) Centre Rail x 1pc

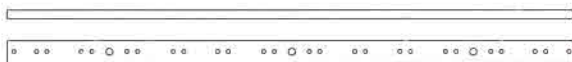

(E) Centre Plastic Slat Holders x 13pcs



(F) Side Plastic Slat Holders x 26pcs



(G) Wooden Slats x 26pcs

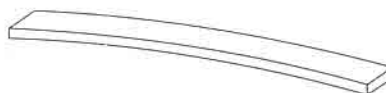

(H) Support Leg x 3pcs



(I) Metal Cross Bar x 1pc



FITTINGS

1. JCBB M8 x 20mm x 8pcs



5. CSK Screw M4 x 32mm x 2pcs



9. M6 HEX Nut x 2pcs



2. M8 Flat Washer x 8pcs



6. M4 Allen Key x 1pc



10. 10mm Spanner M6 x 1pc



3. M8 Spring Washer x 8pcs



7. M5 Allen Key x 1pc



4. JCBC M6 x 40mm x 3pcs



8. M6 x 19 Flat Washer x 2pcs



Step 1: Attach the Siderails (C) to the headend (A) and Footend (B) by using JCBB M8 x 20mm (1) and M8 Spring Washer (3) and M8 Flat Washer (2) tighten using M5 Allen Key (7)

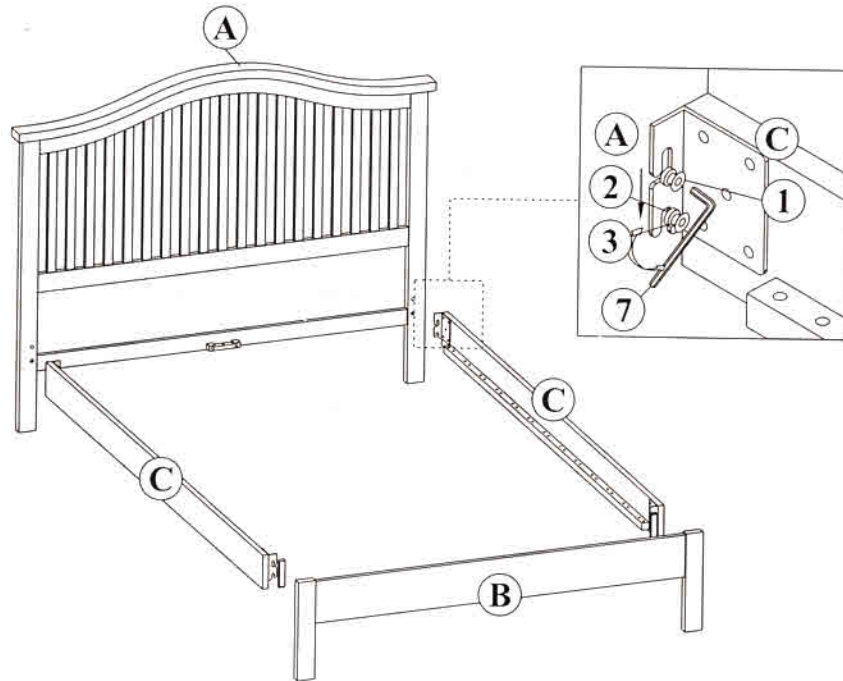

Step 2: Fix the Support Legs (H) 3pcs to the Centre Rail (D). Fix the Centre Rail (D), Support Legs (H) to the Headend (A) and Footend (B) with JCBC M6 x 40mm (4), M6 Hex Nut (9), M6 Flat Washer (8). Tighten using Allen Key M4 (6) & Spanner (10).

Fix the Metal Cross Bar (I) and Center Rail (D) secure in place with JCBC M6 x 40mm (4). Tighten using Allen Key M4 (6). Fix the Metal Cross Bar (I) to the Side Rail L & R (C) with CSK Screw M4 x 32mm (5). Tighten using screw driver.

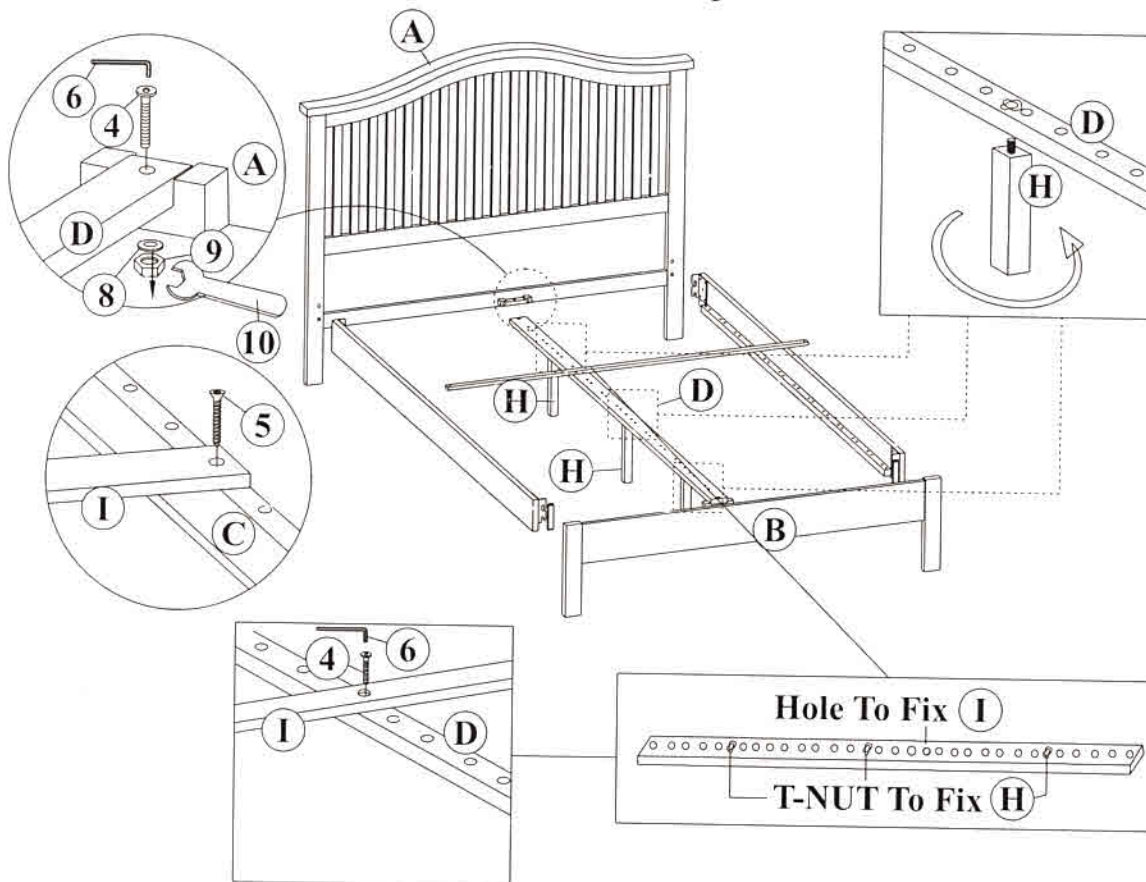

Step 3: Insert the Wooden Slat (G) into the Plastic Slat Holders (E) (F)

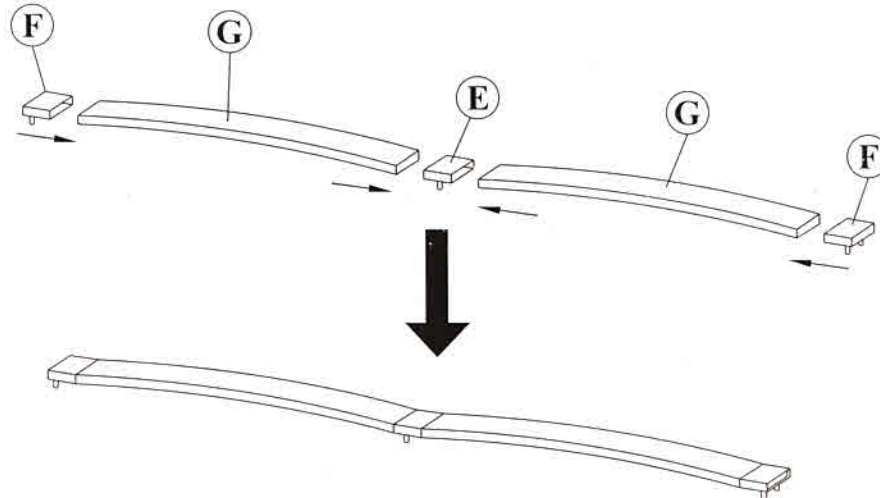

Step 4: Align the pins on the Plastic Slat Holders (E) (F) to the holes along the Centre Rail (D) and the Siderails (C). Gently tap them into the holes. Tap the corners of the Plastic Slat Holders (E) (F) to knock them into place with rubber mallet. (**NOT** provided)

