

# MEDIUM OAK EFFECT QUEBEC WAVE EDGE COFFEE TABLE ASSEMBLY INSTRUCTIONS

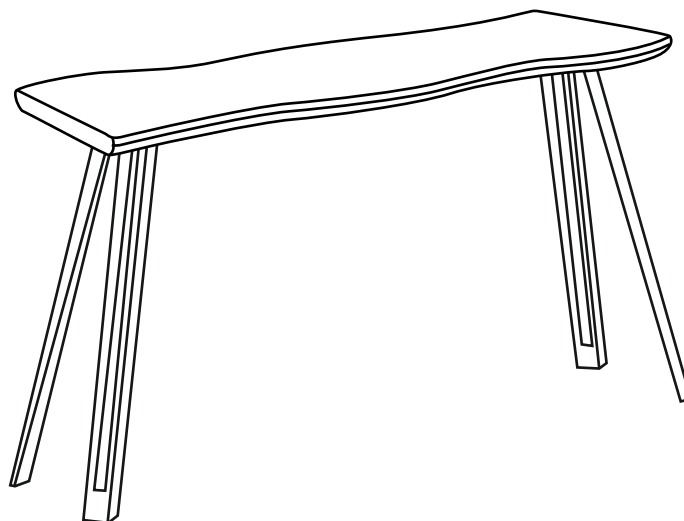

FOR DOMESTIC USE ONLY  
IMPORTANT

PLEASE READ BEFORE YOU CONTINUE FURTHER

THE PRODUCT YOU HAVE PURCHASED WILL GIVE YOU MANY YEARS OF SERVICE IF YOU FOLLOW THE GUIDELINES FOR ITS SAFE ASSEMBLY AND PERIODIC MAINTENANCE AND CLEANING .

ASSEMBLE ON A SOFT CLEAN SURFACE

DO NOT USE ANY TOOLS OTHER THAN THOSE SHOWN.

ANY SPANNERS OR ALLEN KEYS REQUIRED ARE INCLUDED WITH THE FITTINGS KIT.

DO NOT FOR ANY REASON USE A POWER TOOL TO ASSEMBLE THIS PRODUCT. ITS USE WILL INVALIDATE ANY CLAIM YOU MAY HAVE AND COULD MAKE THIS PRODUCT UNSAFE.

DEPENDING ON THE AMOUNT OF USE THIS PRODUCT RECEIVES IT MAY BE NECESSARY TO TIGHTEN UP THE FIXINGS FROM TIME TO TIME . THIS IS COMPLETELY NORMAL FOR ANY FLAT PACK FURNITURE.  
DO NOT OVERTIGHTEN FIXINGS.

FOR CLEANING, YOU MAY USE A DAMP CLOTH (NOT WET) DO NOT USE POLISH, DETERGENT OR CHEMICAL CLEANERS.

THIS PRODUCT MAY STAIN OR MARK IF ALLOWED TO COME INTO CONTACT WITH WET OR DAMP OBJECTS.



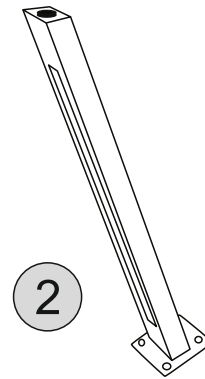
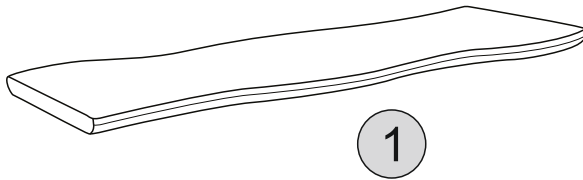



THE SURFACE OF THIS ITEM IS NOT HEAT RESISTANT. ALWAYS USE A PLACE MAT UNDER HOT OR COLD ITEMS TO PREVENT MARKING.

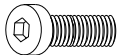

## PARTS LIST

| Part Number | Part Code           | Part Description | Quantity | Carton |
|-------------|---------------------|------------------|----------|--------|
| 1           | S300-304-021-SF1-01 | Table Top        | 1        | 1/2    |
| 2           | S300-304-021-SF1-02 | Table Leg        | 4        | 2/2    |

## HARDWARE LIST

| REF |   | HARDWARE NAME    | QTY   |
|-----|---|------------------|-------|
| A   |  | Bolts M8         | 16PCS |
| B   |  | Allen Key        | 1PC   |
| C   |  | Metal Washer     | 16PCS |
| D   |  | Screw 15mm       | 4PCS  |
| E   |  | Anti-Tip Bracket | 4PCS  |
| F   |  | Anti-Tip Strap   | 2PCS  |

PLEASE CHECK THAT YOU HAVE ALL THE PARTS LISTED BEFORE YOU START ASSEMBLING. IF YOU DO FIND THAT SOMETHING IS MISSING, DO NOT CONTINUE ASSEMBLY. PLEASE CONTACT YOUR SUPPLIER IMMEDIATELY.

# STEP 1

## PARTS REQUIRED

|               |    |
|---------------|----|
| 1 - TABLE TOP | x1 |
|---------------|----|

|               |    |
|---------------|----|
| 2 - TABLE LEG | x4 |
|---------------|----|

## HARDWARE REQUIRED

|   |   |    |
|---|---|----|
| A |  | 16 |
|---|---|----|

|   |   |    |
|---|---|----|
| C |  | 16 |
|---|---|----|

## TOOLS REQUIRED

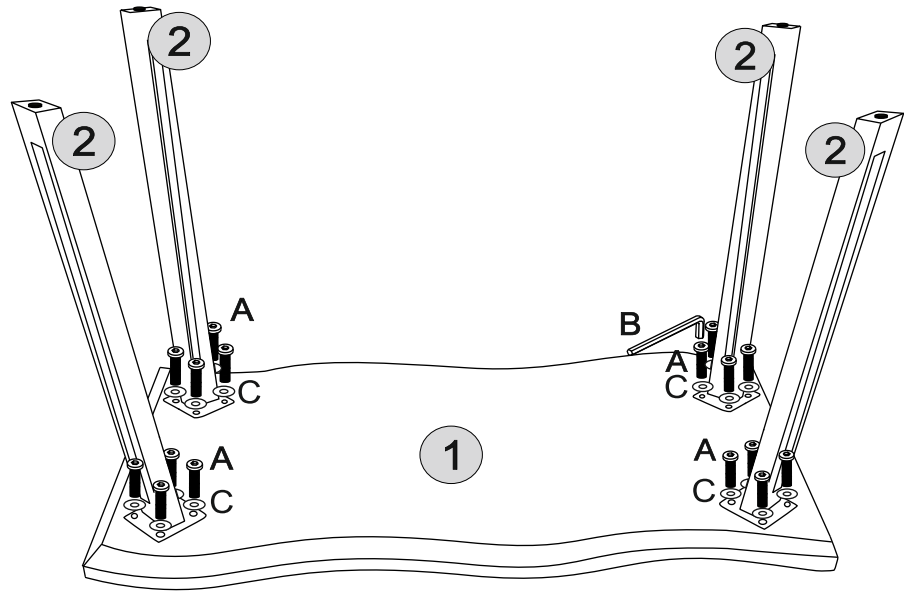
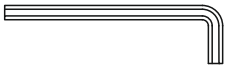

# STEP 2

## PARTS REQUIRED

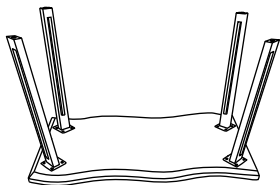

## HARDWARE REQUIRED

|   |   |   |
|---|---|---|
| D |  | 4 |
|---|---|---|

|   |   |   |
|---|---|---|
| E |  | 2 |
|---|---|---|

## TOOLS REQUIRED

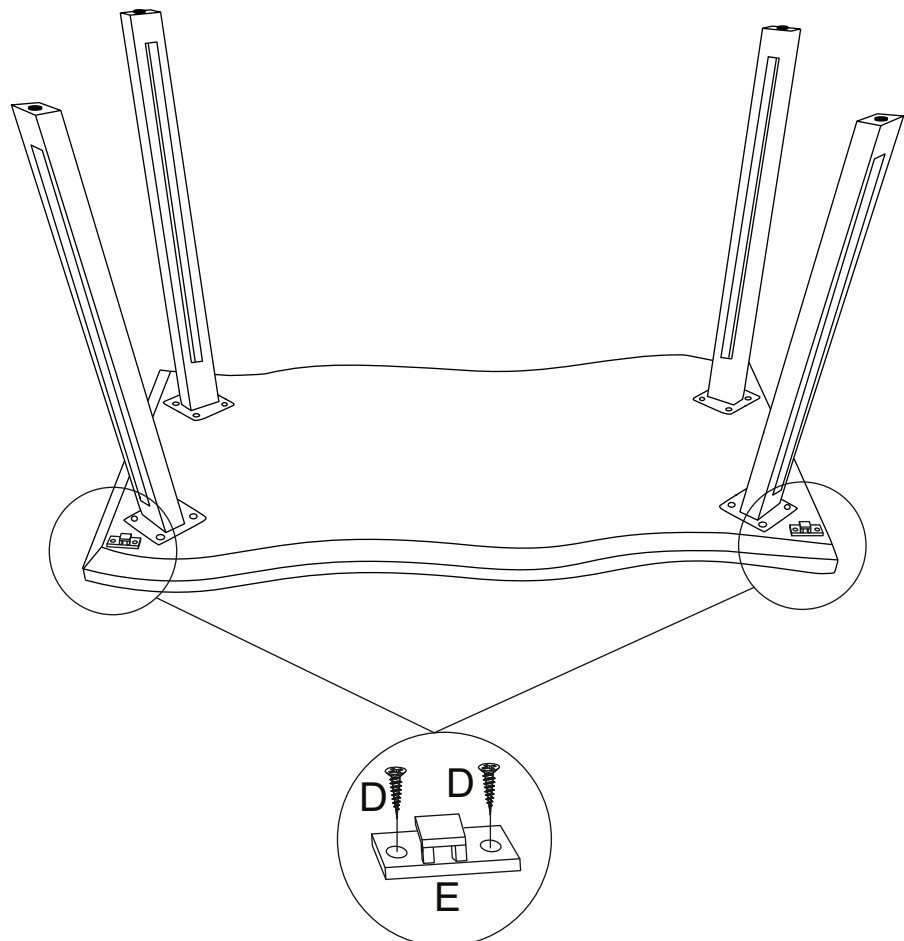
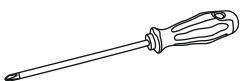

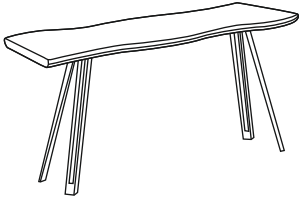

## STEP 3

### PARTS REQUIRED



### HARDWARE REQUIRED

|   |   |   |
|---|---|---|
| E |  | 2 |
| F |  | 2 |

### TOOLS REQUIRED

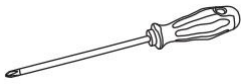

### WARNING

Serious or fatal injuries can occur from furniture tipping over . To prevent the furniture from tipping over we recommend that it is permanently fixed to the wall.

Wall fixings are not supplied with this product as different wall materials require different types of fixing devices. Please make sure you use fixings suitable for the walls in your home.

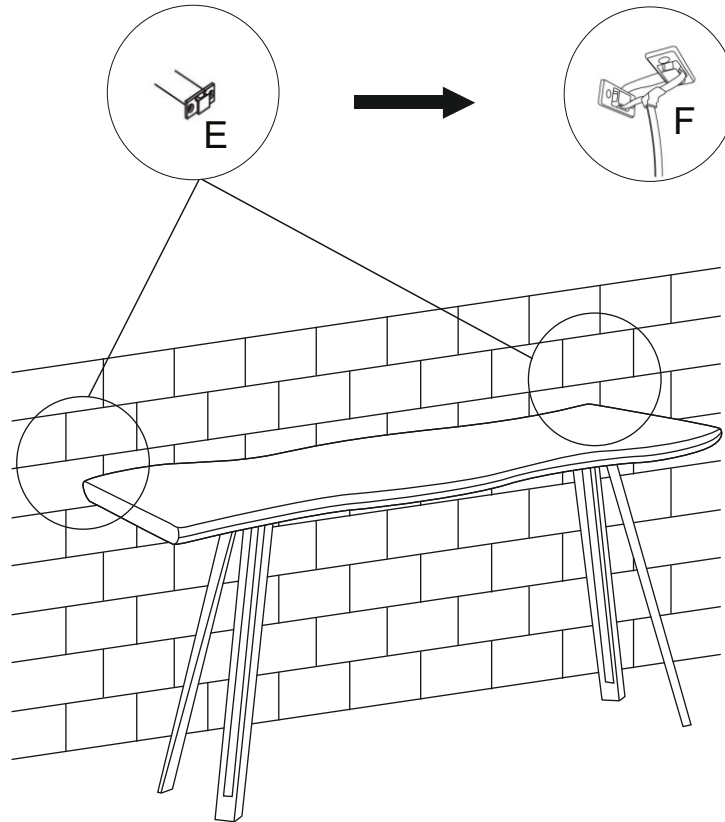

## STEP 4

### PARTS REQUIRED

### HARDWARE REQUIRED

### TOOLS REQUIRED

