

# 2 Seater Sofa Assembly Instructions

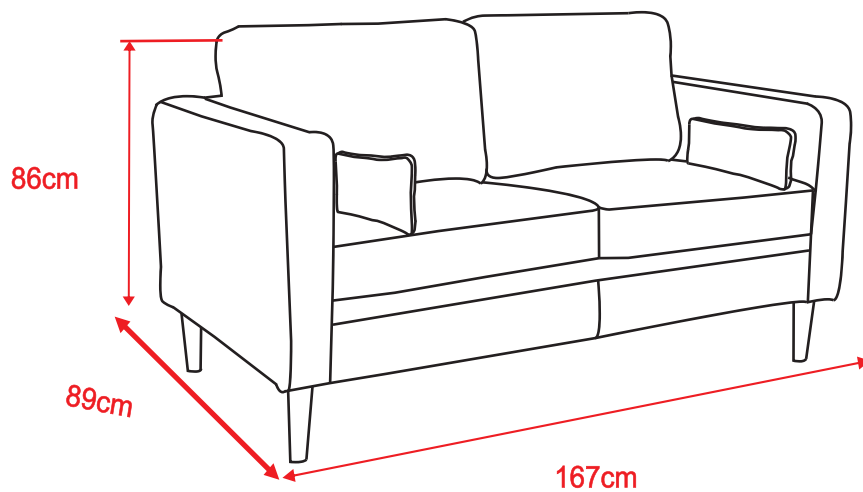

VERSION 190518

HAY002



No Extra  
Tools Required

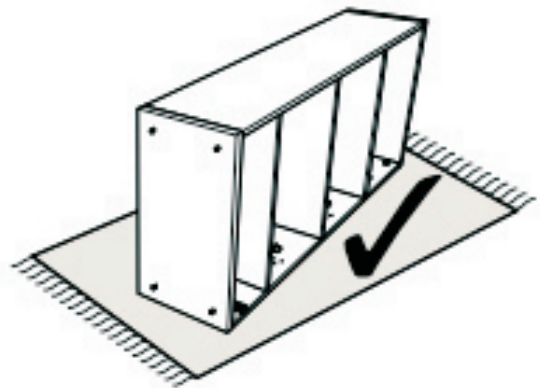
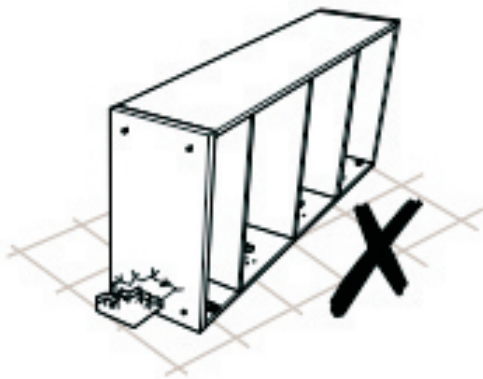
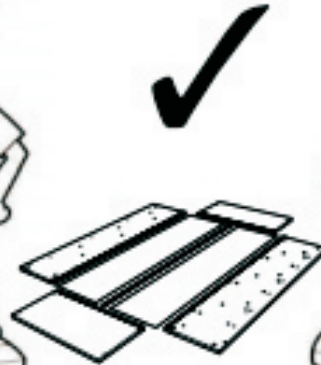
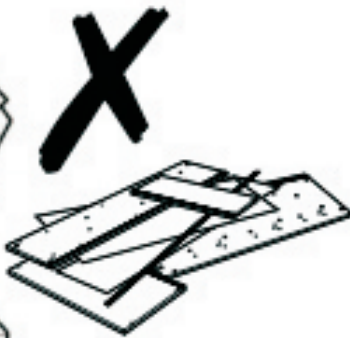
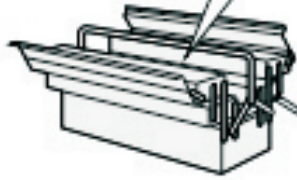

Customer Service  
(01623 727374)

# HARDWARE

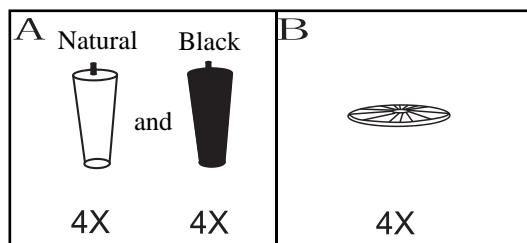

# PARTS

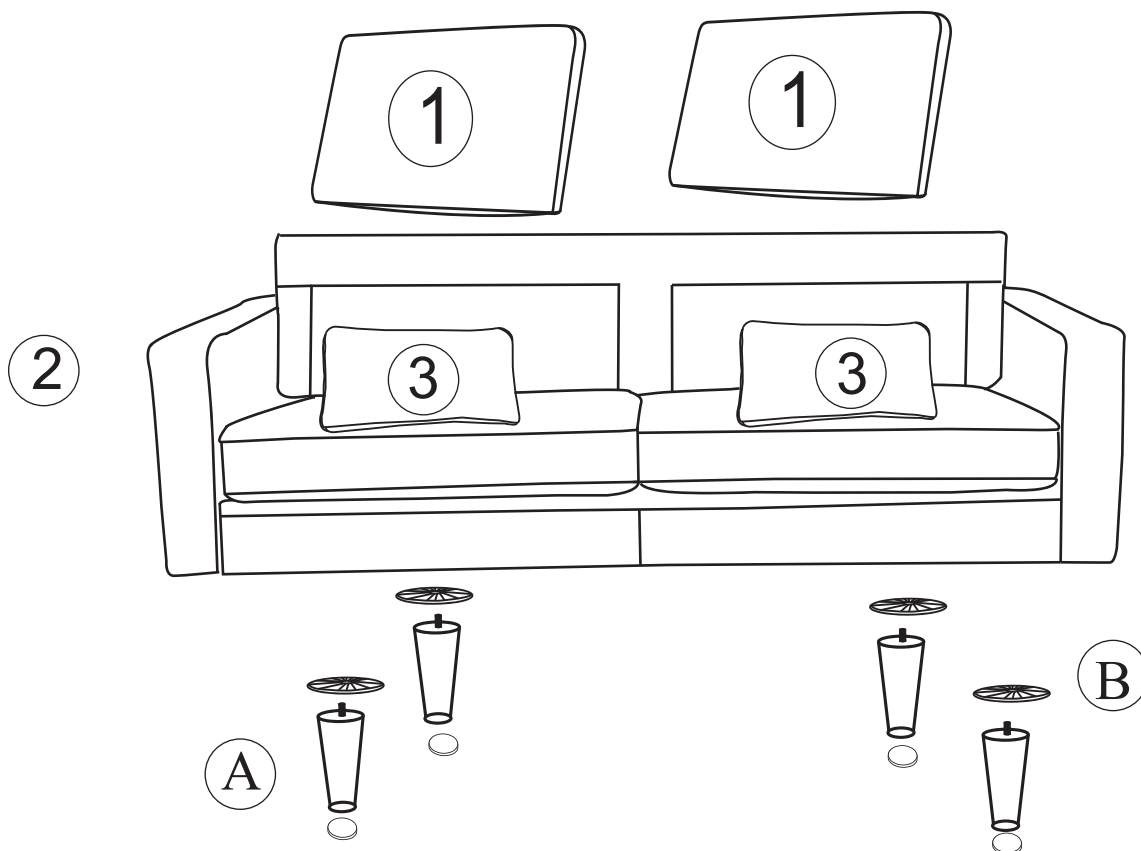

# **Safety Advice**

Please take the time to carefully read through the whole of these instructions before you commence.

Keep these instructions for future reference.

Unpack, inspect and check off all of the contents.

Please dispose of all packaging safely.

Small component parts could choke a child if swallowed.

We strongly recommend that you keep children well away from the work area.

It would be sensible to lay a sheet or blanket on the floor where you intend to work to avoid scratching this product and to protect your floor.

This product is heavy. Take extreme care when lifting to avoid personal injury or damage to the product.

Assemble the product as close to its intended final position in the room as possible.

**HANDY HINT:** If you keep the hardware in a bowl during assembly you will be less likely to lose them.

1

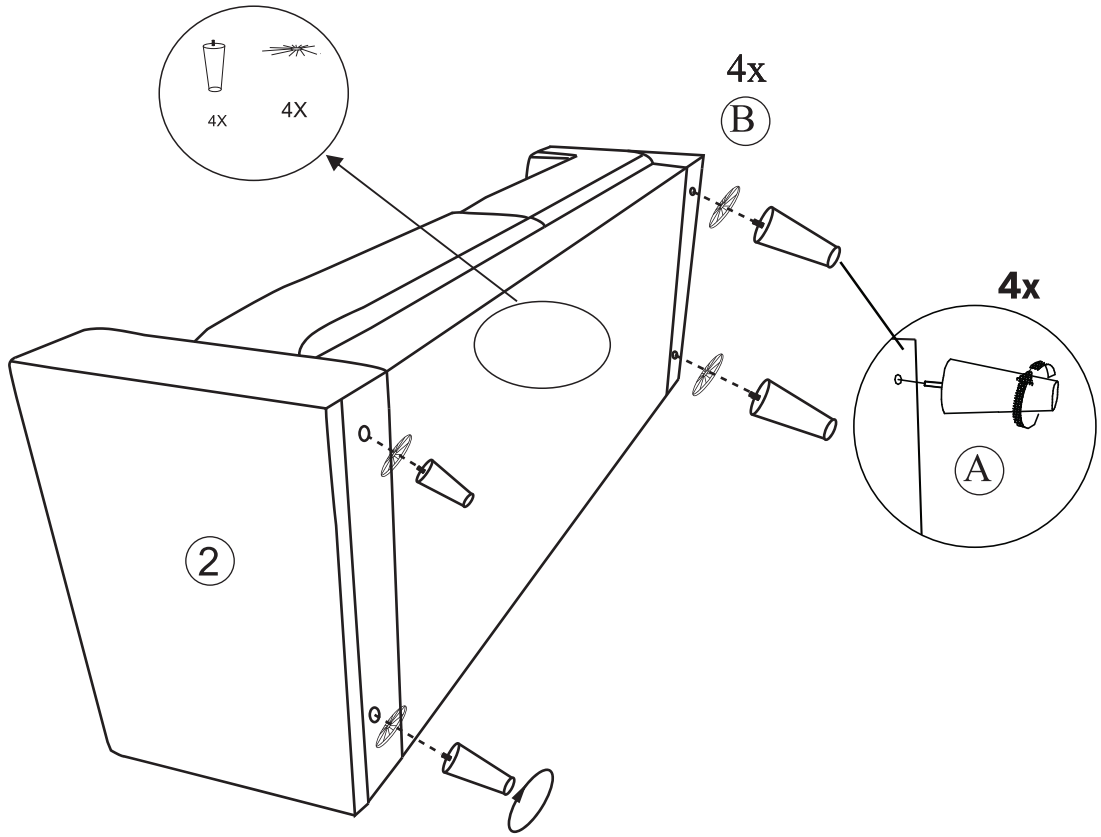

2

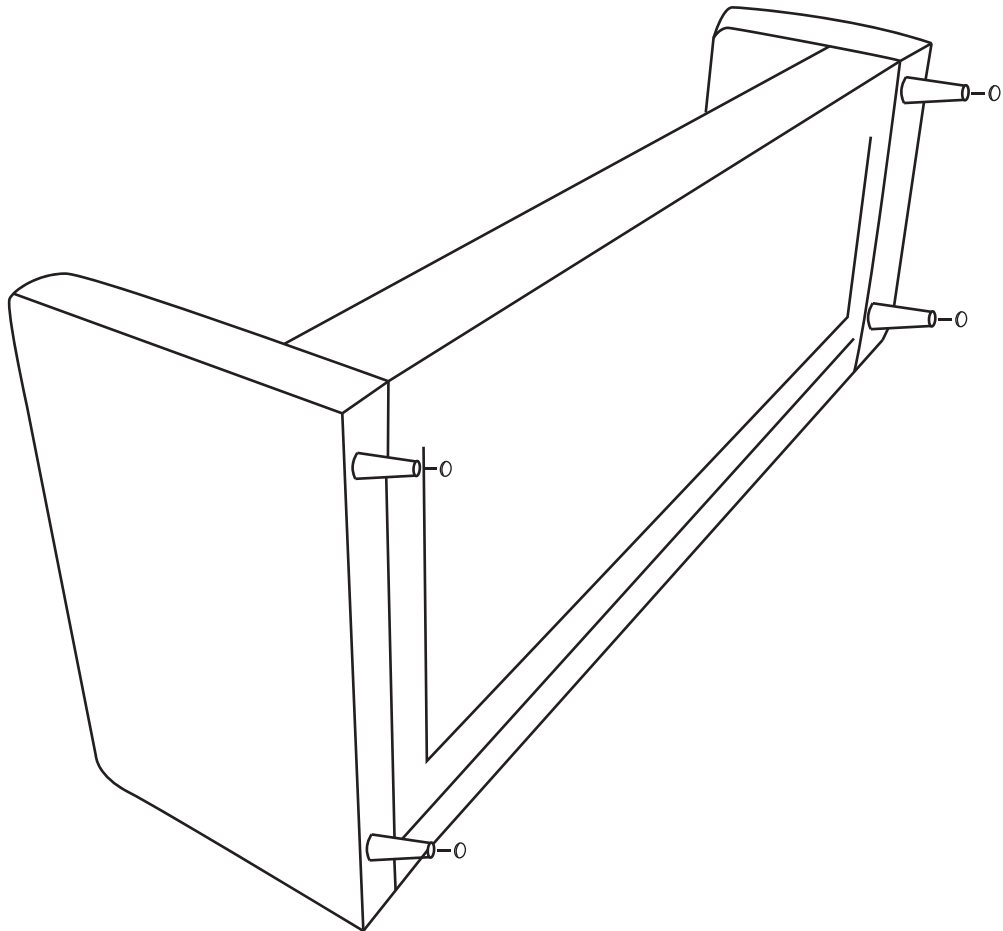

3

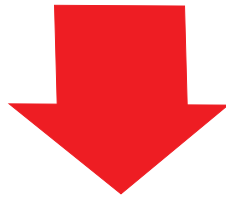
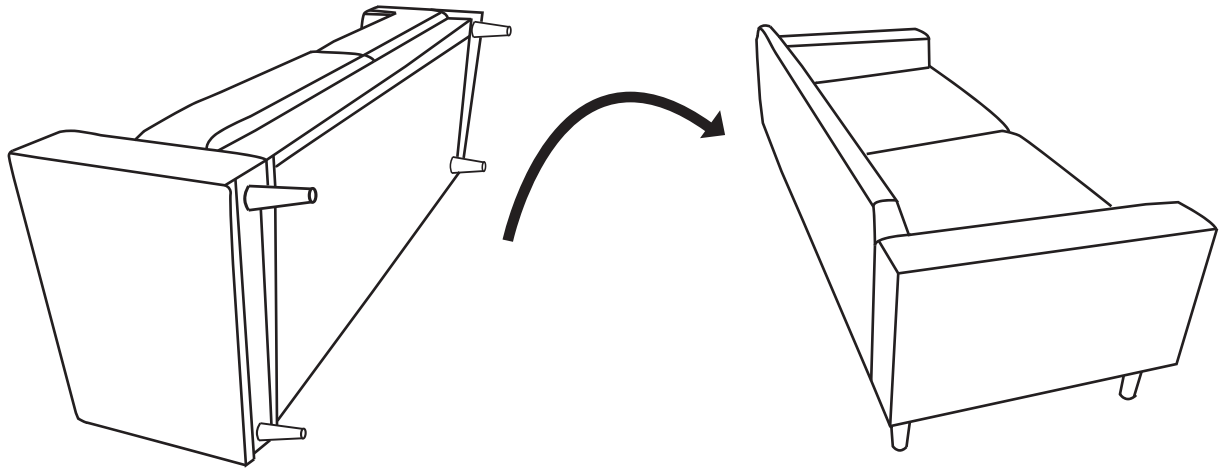

4

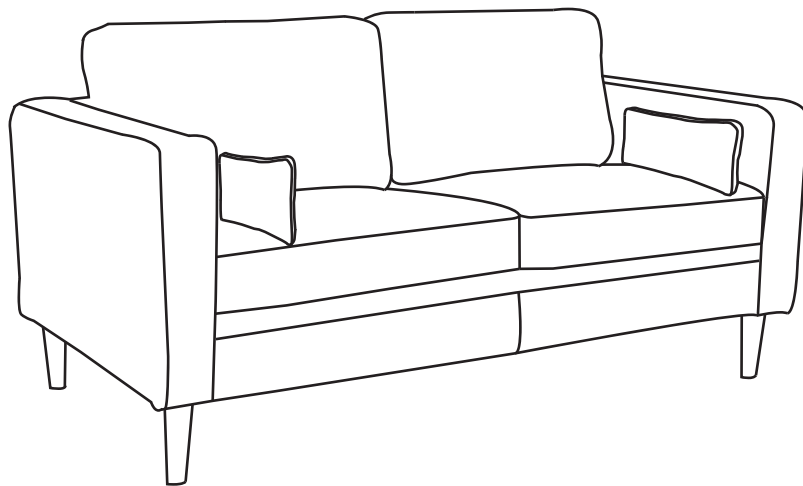

Your 2 seater sofa is now ready for use.

## Care and Maintenance

### Storage:

- **Keep the sofa dry and clean. Use a dust sheet to protect the sofa if it will not be used for a long period.**
- **Do not expose the sofa to strong sunlight or high temperatures as this could cause the fabric to fade.**
- **Do not put any heavy articles on to the armrests as this could damage the sofa and/or cause it to become unstable.**

### Cleaning:

- **Dust off any dust with a sofa bristled hairbrush or a special suede brush.**
- **Never use soap or detergent on the fabrics.**
- **Do not rub the fabric with hard or coarse objects.**
- **Use a damp cloth to wipe the legs, polish should not be used as this can cause abrasion of the wood.**

## Fair Wear and Tear Policy

**Your new sofa is covered by a 12 month manufacturers warranty. This warranty does not cover the following:**

- **Damage from misuse.**
- **Material fading over time or through sunlight.**
- **Damage from spills or leaks.**
- **Collision damage (rubbing against walls, etc).**
- **Accidental tears and damage.**
- **Cigarette and match burns.**

## **General Care**

### **Care and Maintenance**

**When moving your furniture, carefully lift into place. Never drag or push the pieces across the floor as this will cause damage to the joints and could result in failure to the product that will invalidate the warranty.**

## **Recommendations**

**Periodical re-tightening of fixings.**

## **Warning**

**This unit is heavy. Please use an assistant when lifting.**

## **Notes**

**We've tried to make this piece of furniture as easy to assemble as possible.**

**In the unlikely event that you have problems putting it together or have damaged or missing pieces, please contact our customer services on 01623 727374**