

ATHENS RECTANGULAR DINING TABLE ASSEMBLY INSTRUCTIONS



IMPORTANT FOR DOMESTIC USE ONLY PLEASE READ BEFORE YOU CONTINUE FURTHER

THE PRODUCT YOU HAVE PURCHASED WILL GIVE YOU MANY YEARS OF SERVICE IF YOU FOLLOW THE GUIDELINES FOR ITS SAFE ASSEMBLY AND PERIODIC MAINTENANCE AND CLEANING .

ASSEMBLE ON A SOFT CLEAN SURFACE

DO NOT USE ANY TOOLS OTHER THAN THOSE SHOWN.

ANY SPANNERS OR ALLEN KEYS REQUIRED ARE INCLUDED WITH THE FITTINGS KIT.

DO NOT FOR ANY REASON USE A POWER TOOL TO ASSEMBLE THIS PRODUCT. ITS USE WILL INVALIDATE ANY CLAIM YOU MAY HAVE AND COULD MAKE THIS PRODUCT UNSAFE.

DEPENDING ON THE AMOUNT OF USE THIS PRODUCT RECEIVES IT MAY BE NECESSARY TO TIGHTEN UP THE FIXINGS FROM TIME TO TIME . THIS IS COMPLETELY NORMAL FOR ANY FLAT PACK FURNITURE.
DO NOT OVERTIGHTEN FIXINGS.

FOR CLEANING, YOU MAY USE A DAMP CLOTH (NOT WET) DO NOT USE POLISH, DETERGENT OR CHEMICAL CLEANERS.

THIS PRODUCT MAY STAIN OR MARK IF ALLOWED TO COME INTO CONTACT WITH WET OR DAMP OBJECTS.

THE SURFACE OF THIS ITEM IS NOT HEAT RESISTANT. ALWAYS USE A PLACE MAT UNDER HOT OR COLD ITEMS TO PREVENT MARKING.

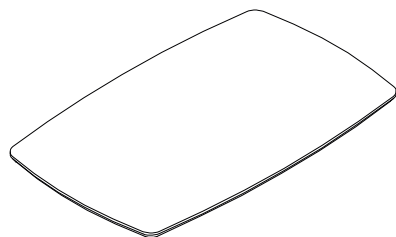

1

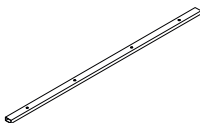

2

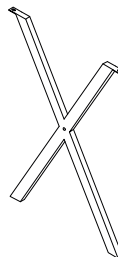

3



4

PARTS LIST

Part Number	Part Code	Part Description	Quantity	Carton
1	S400-403-043-SF1-01	Table Top	1	1/1
2	S400-403-043-SF1-02	Side Support Bar	2	1/1
3	S400-403-043-SF1-03	Table Legs	2	1/1
4	S400-403-043-SF1-04	End Support Bar	2	1/1

HARDWARE LIST

REF		HARDWARE NAME	QTY
A		Bolts M8x25mm	8PCS
B		Bolts M8x40mm	2PCS
C		Bolts M8x18mm	6PCS
D		Adjusting Foot	4PCS
E		Allen Key	1PCS
F		Metal Wsher	8PCS

PLEASE CHECK THAT YOU HAVE ALL THE PARTS LISTED BEFORE YOU START ASSEMBLING. IF YOU DO FIND THAT SOMETHING IS MISSING, DO NOT CONTINUE ASSEMBLY. PLEASE CONTACT YOUR SUPPLIER IMMEDIATELY.

STEP 1

PARTS REQUIRED

1 - TABLE TOP x1

2 - SIDE SUPPORT BAR x2

HARDWARE REQUIRED

A  08

TOOLS REQUIRED

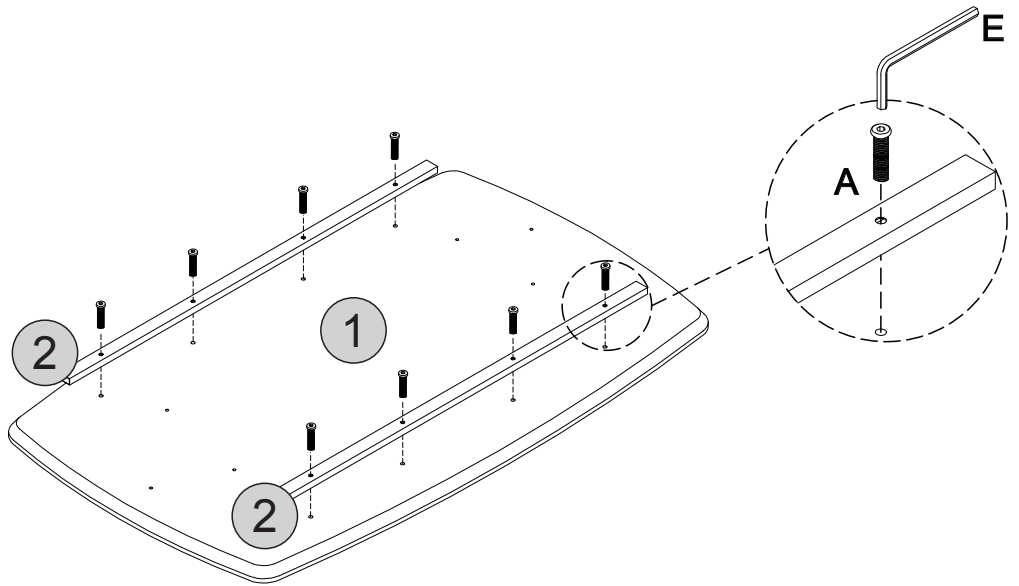
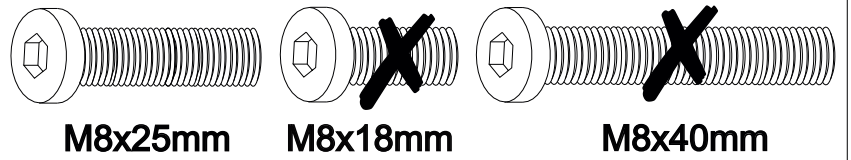

STEP 2

PARTS REQUIRED

3 - TABLE LEGS x2

4 - END SUPPORT BAR x2

HARDWARE REQUIRED

B  02

F  02

TOOLS REQUIRED

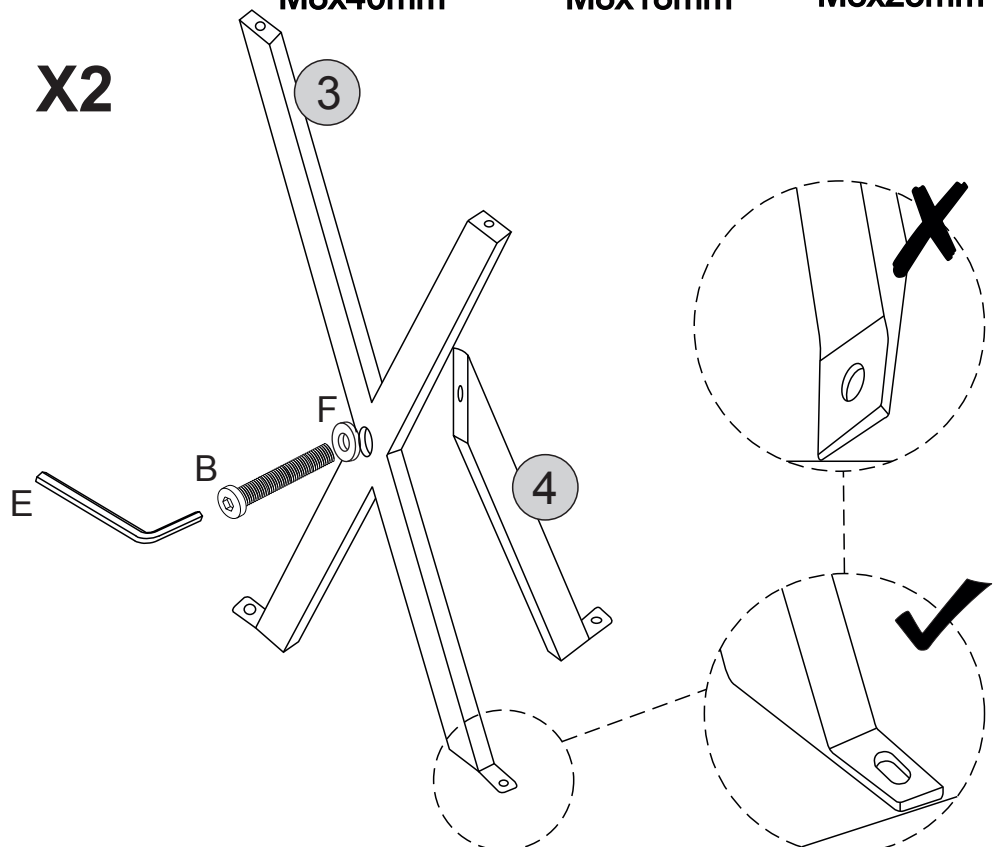
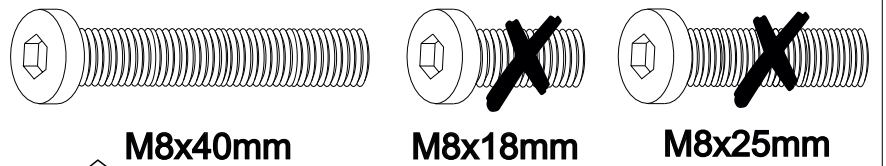
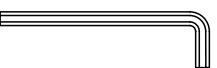

STEP 3

PARTS REQUIRED

1 - TABLE TOP x1

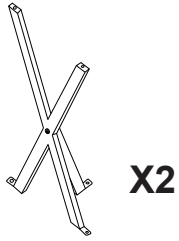

HARDWARE REQUIRED

C  06

D  04

F  06

TOOLS REQUIRED

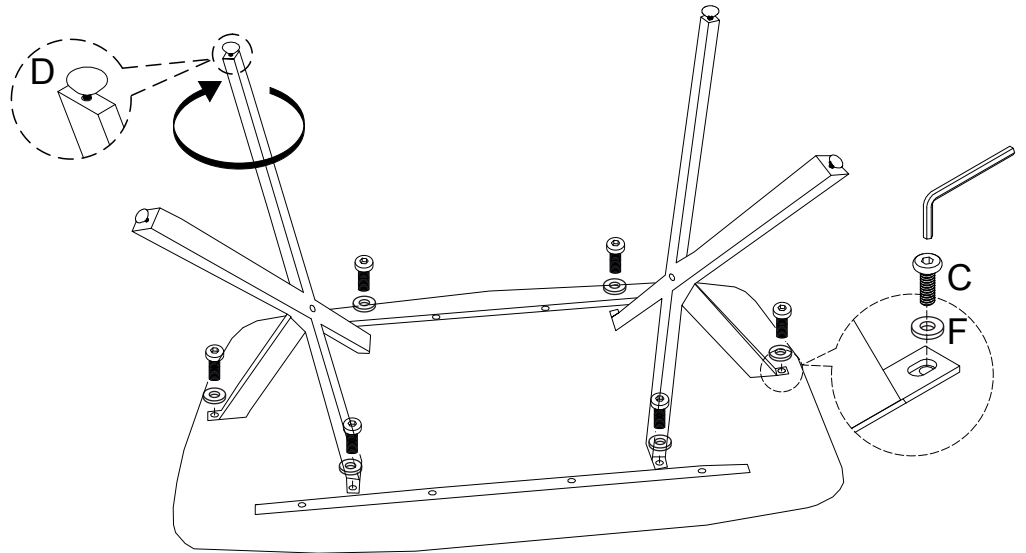
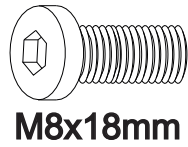
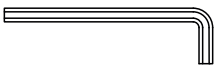

STEP 4

PARTS REQUIRED

HARDWARE REQUIRED

TOOLS REQUIRED



LUKAS DINING CHAIR ASSEMBLY INSTRUCTIONS

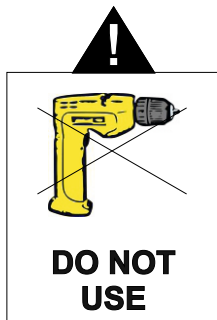

**MAX CHAIR
WEIGHT**

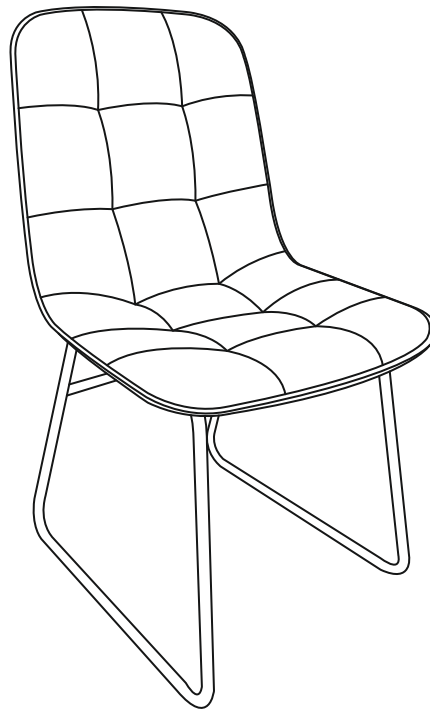

IMPORTANT FOR DOMESTIC USE ONLY PLEASE READ BEFORE YOU CONTINUE FURTHER

THE PRODUCT YOU HAVE PURCHASED WILL GIVE YOU MANY YEARS OF SERVICE IF YOU FOLLOW THE GUIDELINES FOR ITS SAFE ASSEMBLY AND PERIODIC MAINTENANCE AND CLEANING .

ASSEMBLE ON A SOFT CLEAN SURFACE

DO NOT USE ANY TOOLS OTHER THAN THOSE SHOWN.

ANY SPANNERS OR ALLEN KEYS REQUIRED ARE INCLUDED WITH THE FITTINGS KIT.

DO NOT FOR ANY REASON USE A POWER TOOL TO ASSEMBLE THIS PRODUCT. ITS USE WILL INVALIDATE ANY CLAIM YOU MAY HAVE AND COULD MAKE THIS PRODUCT UNSAFE.

DEPENDING ON THE AMOUNT OF USE THIS PRODUCT RECEIVES IT MAY BE NECESSARY TO TIGHTEN UP THE FIXINGS FROM TIME TO TIME . THIS IS COMPLETELY NORMAL FOR ANY FLAT PACK FURNITURE.

DO NOT OVERTIGHTEN FIXINGS.

FOR CLEANING, YOU MAY USE A DAMP CLOTH (NOT WET) DO NOT USE POLISH, DETERGENT OR CHEMICAL CLEANERS.

THIS PRODUCT MAY STAIN OR MARK IF ALLOWED TO COME INTO CONTACT WITH WET OR DAMP OBJECTS.

THE SURFACE OF THIS ITEM IS NOT HEAT RESISTANT. ALWAYS USE A PLACE MAT UNDER HOT OR COLD ITEMS TO PREVENT MARKING.

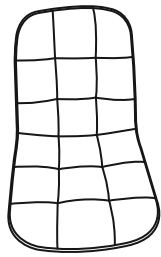

1



2



3



4

PARTS LIST

Part Number	Part Description	Quantity	Carton
1	Seat Pad	1	1/1
2	Chair Leg (L)	1	1/1
3	Chair Leg (R)	1	1/1
4	Chair Support Bar	1	1/1

HARDWARE LIST

REF		HARDWARE NAME	QTY
A		Bolts M6x18mm	8PCS
B		Bolts M6x13mm	2PCS
C		Metal Washer	8PCS
D		Metal Washer	2PCS
E		Allen Key	1PC

PLEASE CHECK THAT YOU HAVE ALL THE PARTS LISTED BEFORE YOU START ASSEMBLING. IF YOU DO FIND THAT SOMETHING IS MISSING, DO NOT CONTINUE ASSEMBLY. PLEASE CONTACT YOUR SUPPLIER IMMEDIATELY.

STEP 1

PARTS REQUIRED

2 - CHAIR LEG (A) x1

3 - CHAIR LEG (B) x1

4 - CHAIR SUPPORT BAR x1

HARDWARE REQUIRED

B  02

D  02

TOOLS REQUIRED

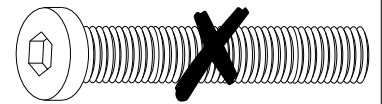

M6x18mm

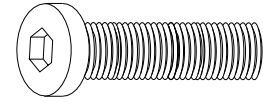

M6x13mm

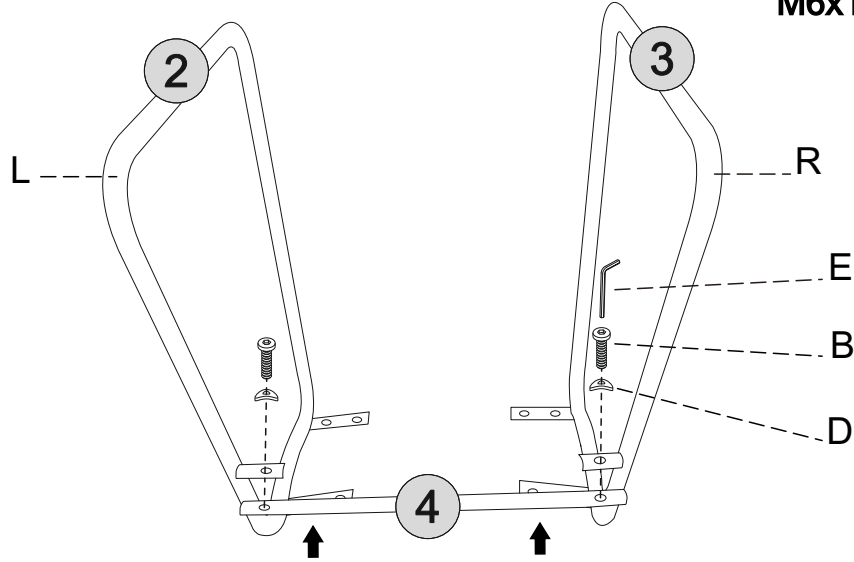

STEP 2

PARTS REQUIRED

1 - SEAT PAD x1

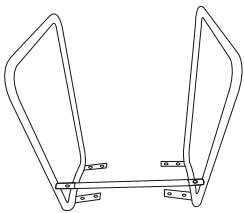

HARDWARE REQUIRED

A  08

C  08

TOOLS REQUIRED

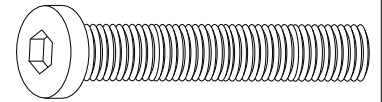

M6x18mm

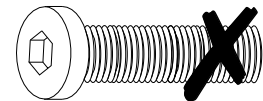

M6x13mm

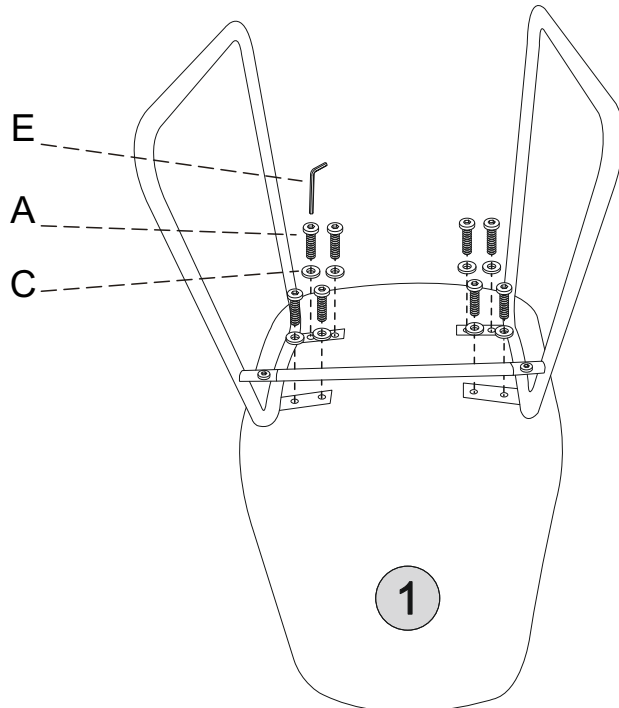

MAX CHAIR WEIGHT

