

NEVADA 3 DOOR 2 DRAWER WARDROBE ASSEMBLY INSTRUCTIONS

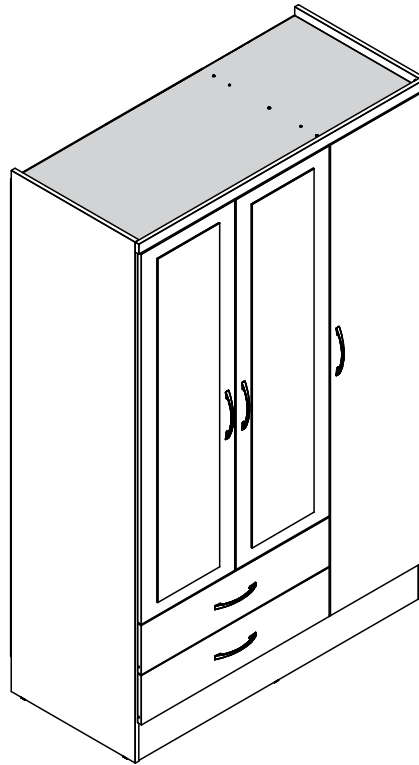

IMPORTANT FOR DOMESTIC USE ONLY PLEASE READ BEFORE YOU CONTINUE FURTHER CARE AND MAINTENANCE

After unpacking this product please keep the original packaging in case it needs to be returned for any reason.

- Please ensure all fittings and parts are present before commencing with assembly.
- Never drag or push products as this could cause damage to the joints making it inferior.
- We strongly recommend that you keep children away from your work area.
- We recommend that you lay a blanket or sheet on the floor to avoid damage to both your floor and the product.
- Assemble this product as close to its final position as possible.
- Do not place this product next to a radiator or in direct sunlight.
- Do not drag or push items across your high gloss furniture as this may cause the surface to scratch
- Wood is a natural product and may expand if subjected to damp and may shrink or crack if subjected to heat. Therefore it is recommended that room temperature is maintained, with no sudden temperature fluctuations.
- Make sure any spillage is wiped off immediately.
- Do not place hot or chilled items directly on to the surface, use a place mat or marking will occur.
- For general cleaning use a soft cotton or micro fibre cloth, and do not use detergents of any kind.
- From time to time it may be necessary to tighten fittings, regular inspections should be carried out.
- Do not place on a wet or damp floor as staining may occur to your floor.

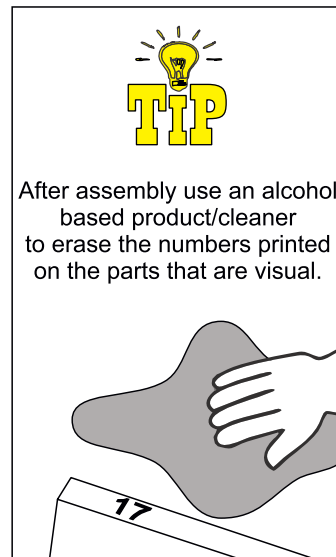
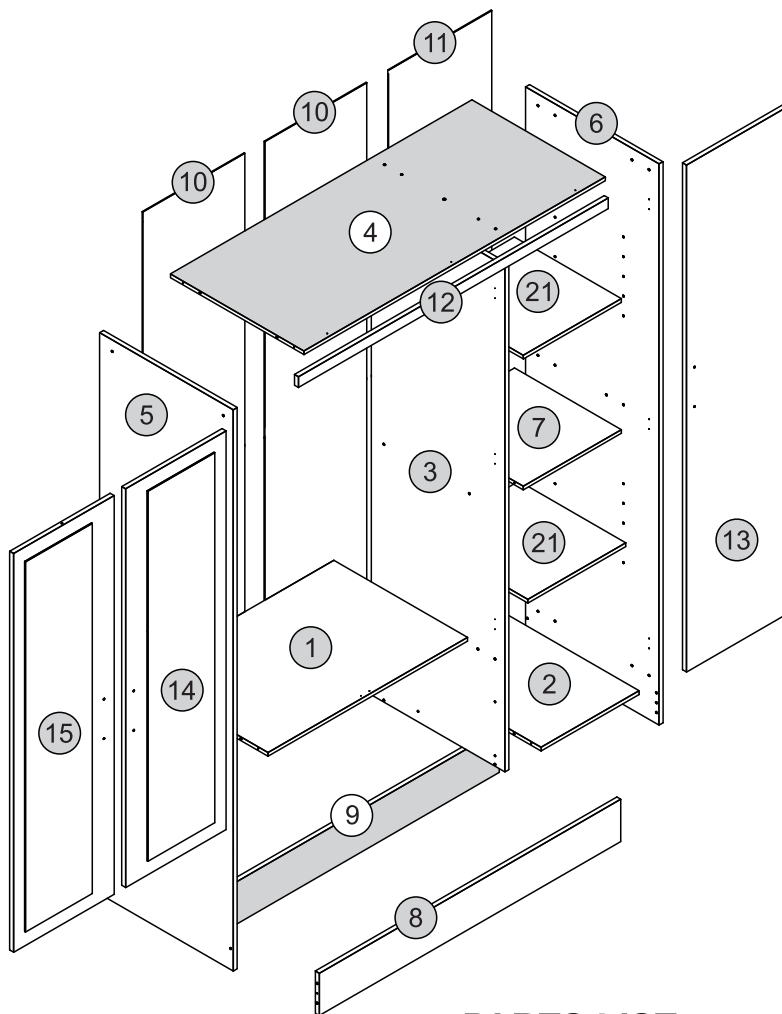

PARTS LIST







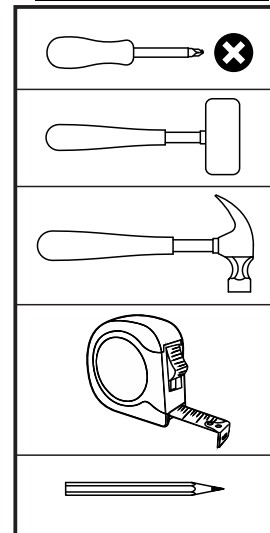

Please Note:
The below parts have all been stamped with the part number to help identify them during assembly.

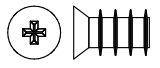
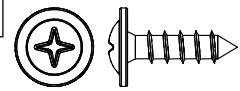
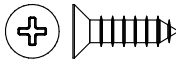
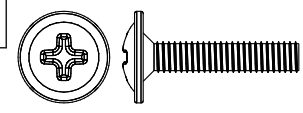
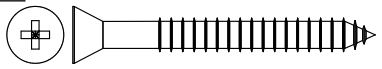
Part Number	Part Description	Quantity	Carton
01	Large Base Panel	1	2/3
02	Small Base Panel	1	2/3
03	Division Panel	1	1/3
04	Top Panel	1	2/3
05	Left Side Panel	1	1/3
06	Right Side Panel	1	1/3
07	Shelf	1	2/3
08	Front Baseboard	1	2/3
09	Back Baseboard	1	2/3
10	Small Back Panel	2	3/3
11	Large Back Panel	1	3/3
12	Frame	1	1/3
13	Large Door	1	3/3
14	Right Small Door	1	3/3
15	Left Small Door	1	3/3
16	Drawer Side	4	2/3
17	Drawer Back Panel	2	2/3
18	Drawer Front	2	2/3
19	Drawer Botom	2	1/3
20	Drawer Botom Support Bar	2	2/3
21	Movable Shelf	2	2/3

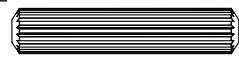
TOOLS REQUIRED

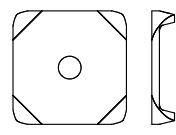
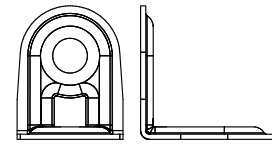
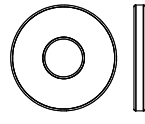
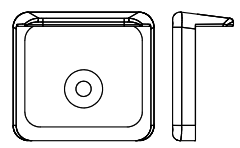
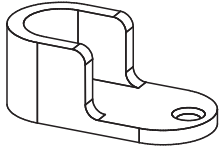
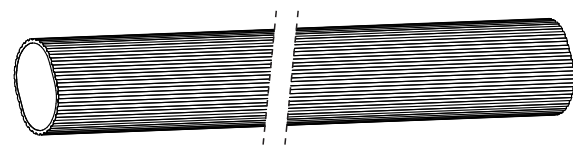
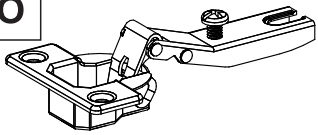
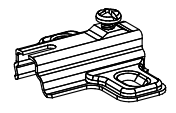
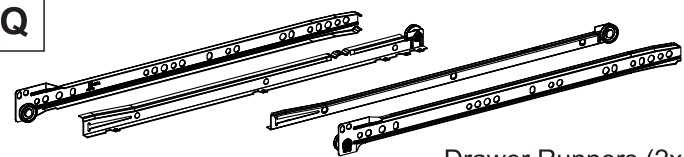
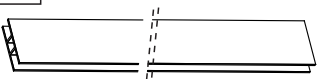

FITTINGS LIST

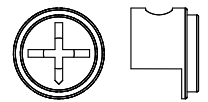
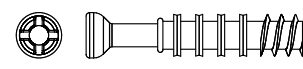
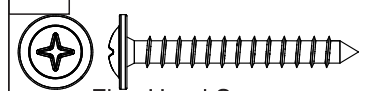
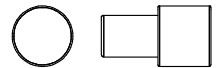
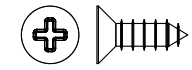
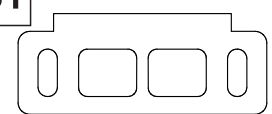
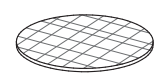
<p>A</p>  <p>Flat Head Screw Ø6,0 x 10mm (8x)</p> <p>1/+</p>	<p>B</p>  <p>Flan Head Screw Ø4,0 x 14mm (9x)</p> <p>1/+</p>	<p>C</p>  <p>Flat Head Screw Ø4,0 x 14mm (52x)</p> <p>2/+</p>	<p>D</p>  <p>Flan Head Screw Ø4,0 x 20mm (10x)</p> <p>2/+</p>
<p>E</p>  <p>Flat Head Screw Ø3,5 x 40mm (4x)</p> <p>1/+</p>	<p>F</p>  <p>Flat Head Screw Ø4,0 x 50mm (26x)</p> <p>2/+</p>		<p>G</p>  <p>2/+ Dowel Ø6,0 x 30mm (46x)</p>
<p>H</p>  <p>2/+ Nail 10 x 10 (88x)</p>	<p>I</p>  <p>2/+ Back Panel Bracket (16x)</p>	<p>J</p>  <p>1/+ 'L' Metallic Support (7x)</p>	<p>K</p>  <p>1/+ Washer (4x)</p>
<p>L</p>  <p>1/+ Plastic Foot (6x)</p>	<p>M</p>  <p>Hanging Rail Support (2x)</p>	<p>N</p>  <p>Hanging Rail (1x)</p>	
<p>O</p>  <p>Hinge (9x)</p>	<p>P</p>  <p>Hinge Plate (9x)</p>	<p>Q</p>  <p>Drawer Runners (2x)</p>	
<p>R</p>  <p>Back Panel Strip (1x)</p>	<p>S</p>  <p>Strap (2x)</p>	<p>T</p>  <p>Handle (5x)</p>	<p>U</p>  <p>4/+ Hole Plugs (14x)</p>
<p>V</p>  <p>Glue (2x)</p>	<p>W</p>  <p>1/+ Cam Nut (4x)</p>	<p>X</p>  <p>1/+ Cam Bolt (4x)</p>	<p>Y</p>  <p>1/+ Flan Head Screw Ø3,5 x 30mm (2x)</p>
<p>Z</p>  <p>1/+ Support Pin (8x)</p>	<p>A1</p>  <p>2/+ Flat Head Screw Ø4,0 x 12mm (18x)</p>	<p>B1</p>  <p>Door Support (2x)</p>	<p>C1</p>  <p>4/+ Hole Plugs (08x)</p>

TIPS FOR FITTINGS CAM-LOCKS

WHEN FITTING CAM NUT. ENSURE STARTING POSITION IS CORRECT BEFORE YOU INSERT CONNECTING CAM BOLT TURN CLOCKWISE UNTIL SECURE

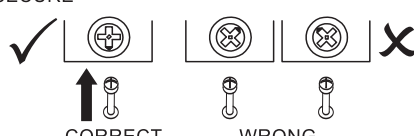

↑ CORRECT
↑ WRONG

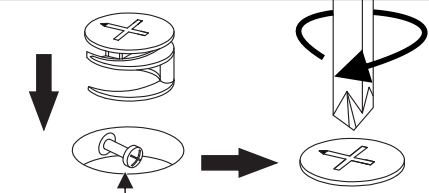

Cam bolt head needs to be in centre

CAMBOLT

Tighten until shoulder in flush with panel. Do not overtighten or undertighten (see example beside)

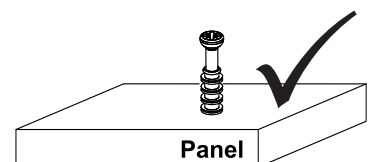
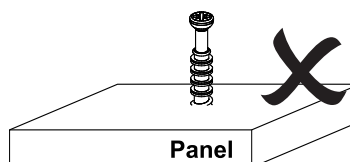
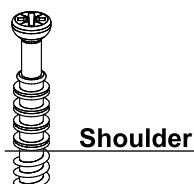



STEP 1

PARTS REQUIRED

3 - DIVISION PANEL x1

HARDWARE REQUIRED

G  02
Ø6.0 x 30mm

V  01
Glue

Z  04

TOOLS REQUIRED

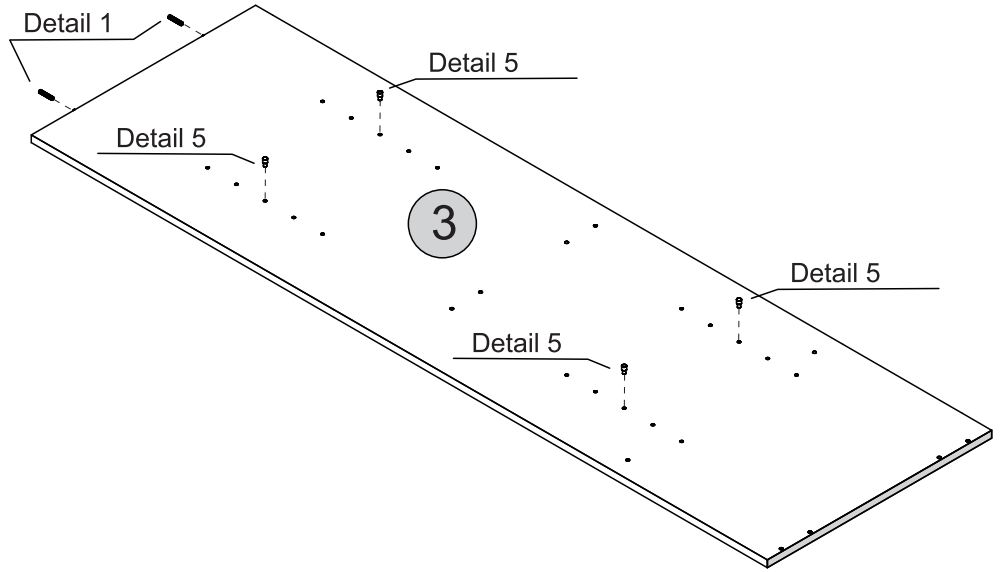
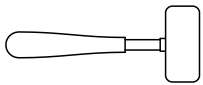

Detail 1

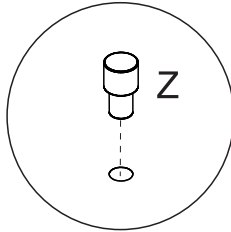

Detail 5

STEP 2

PARTS REQUIRED

3 - DIVISION PANEL x1

HARDWARE REQUIRED

C  08
Ø4,0 x 14mm

M  01

P  03

TOOLS REQUIRED

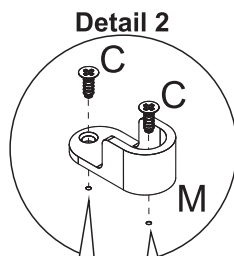
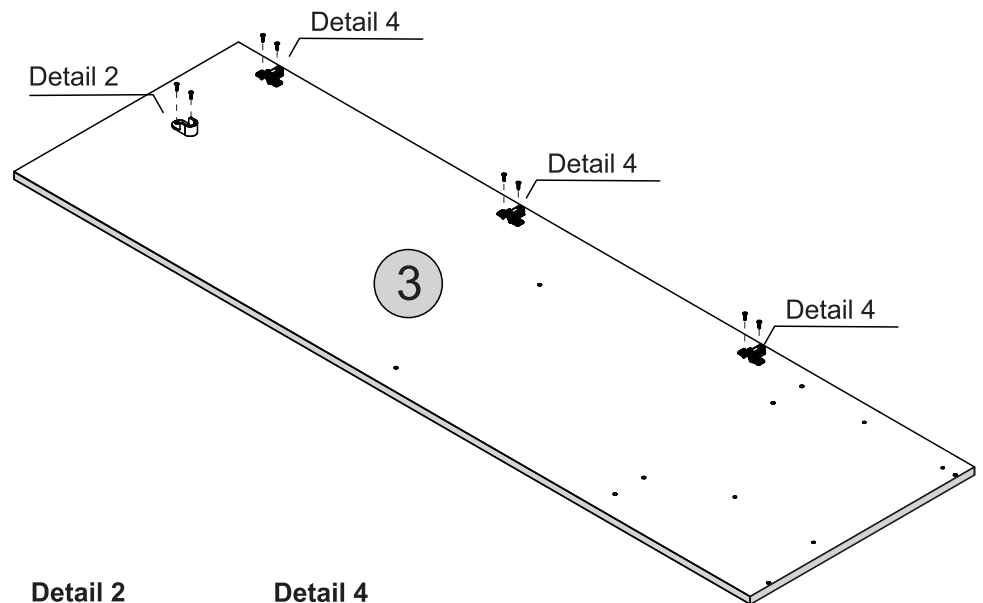
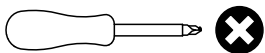

Please note:
Pre-marked
Holes

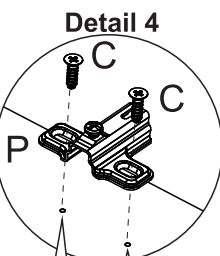

Please note:
Pre-marked
Holes

STEP 3

PARTS REQUIRED

3 - DIVISION PANEL x1

HARDWARE REQUIRED

A  04
Ø6,0 x 10mm

Q  02
Right

TOOLS REQUIRED

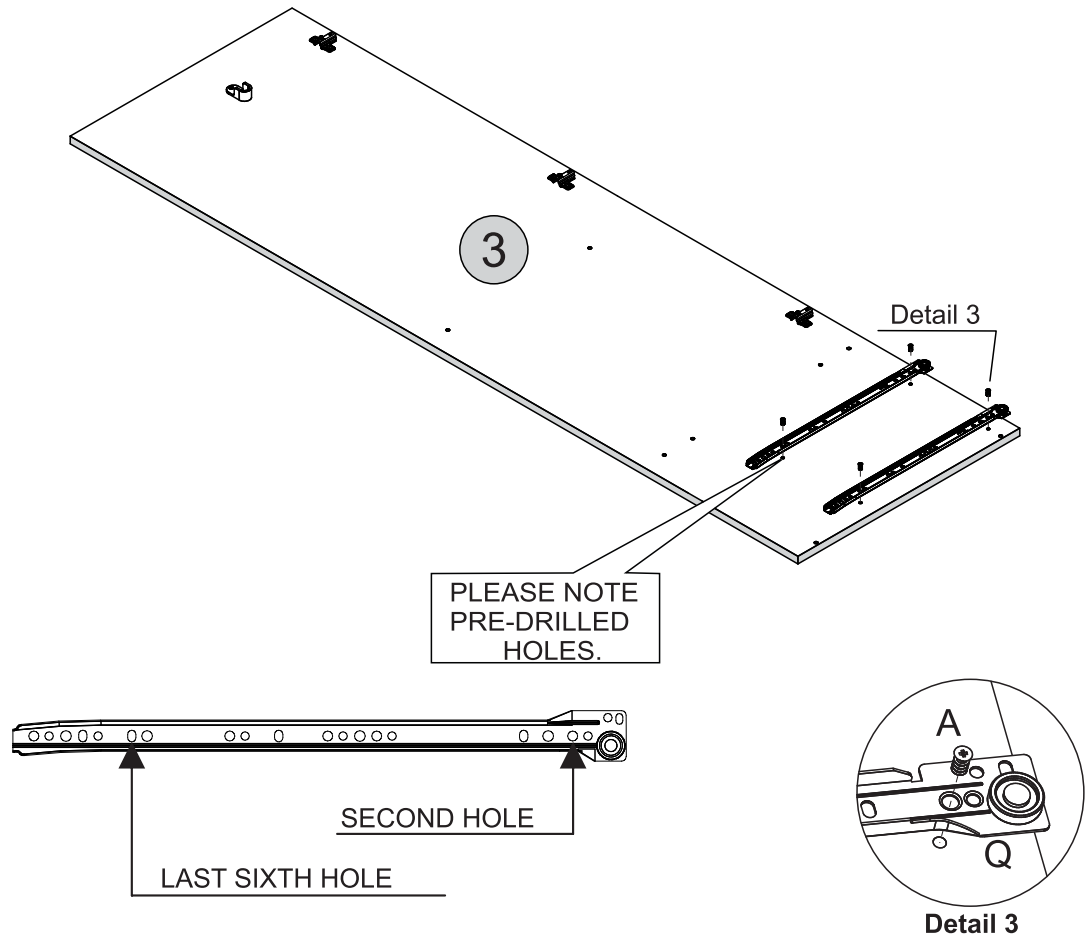
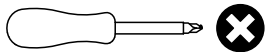

STEP 4

PARTS REQUIRED

5 - LEFT SIDE PANEL x1

HARDWARE REQUIRED

C  08
Ø4,0 x 14mm

M  01

P  03

TOOLS REQUIRED

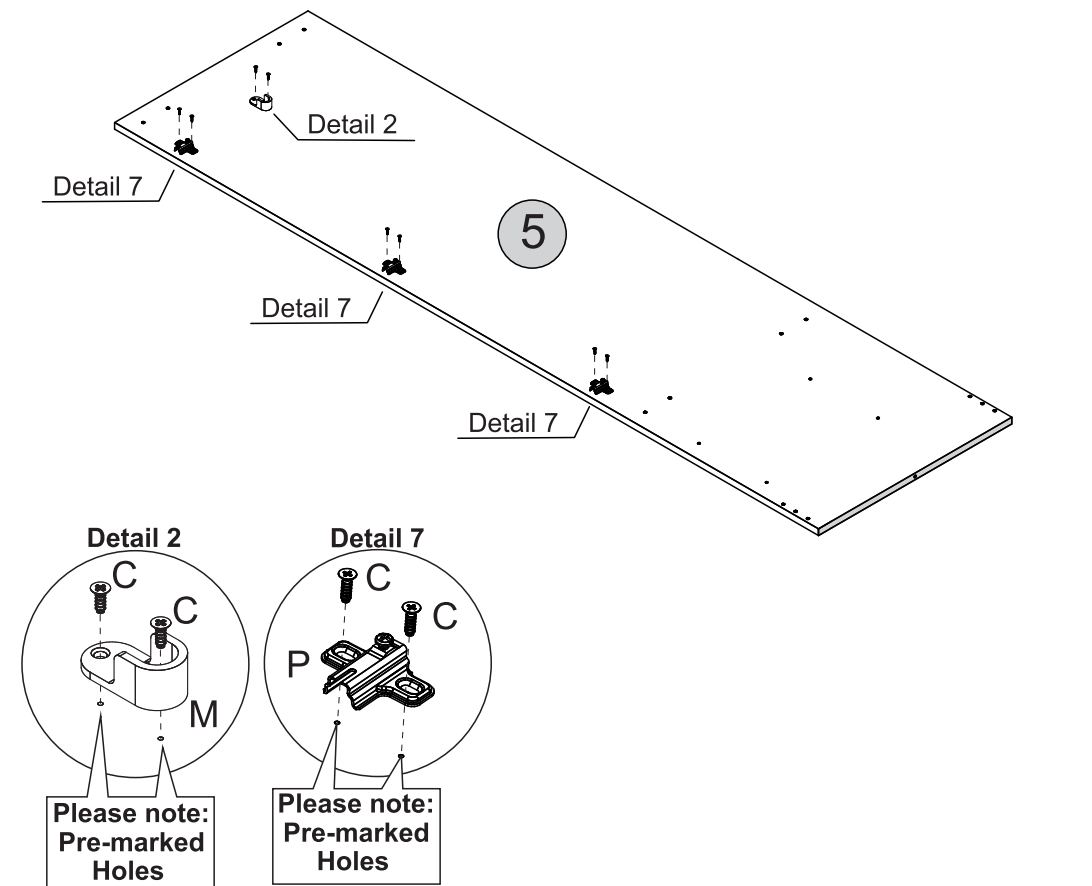
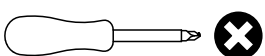

STEP 5

PARTS REQUIRED

5 - LEFT SIDE PANEL x1

HARDWARE REQUIRED

A  04
Ø6,0 x 10mm

H  02

L  02

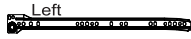
Q  02

TOOLS REQUIRED

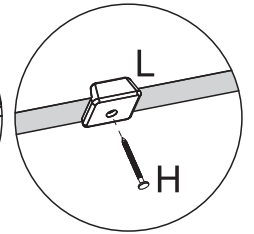
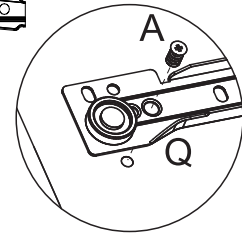
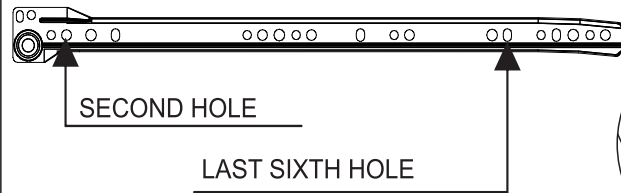
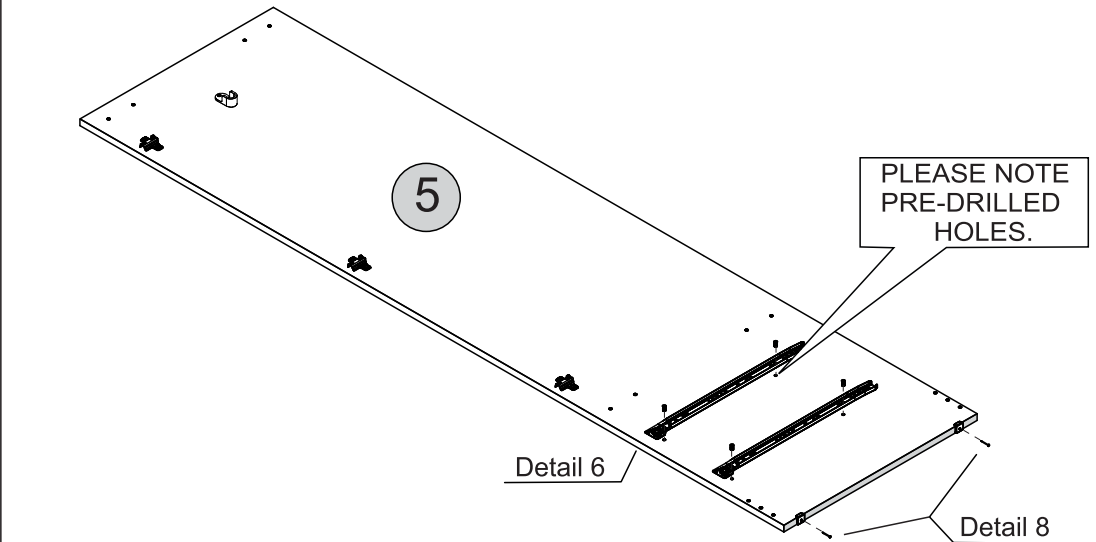
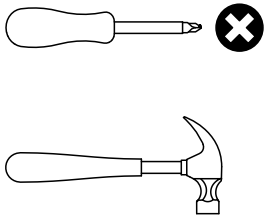



STEP 6

PARTS REQUIRED

6 - RIGHT SIDE PANEL x1

HARDWARE REQUIRED

C  06
Ø4,0 x 14mm

P  03

Z  04

TOOLS REQUIRED

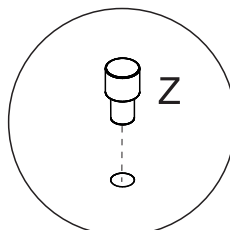
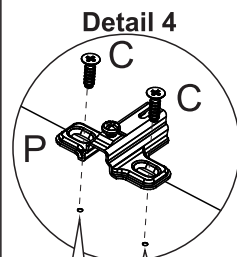
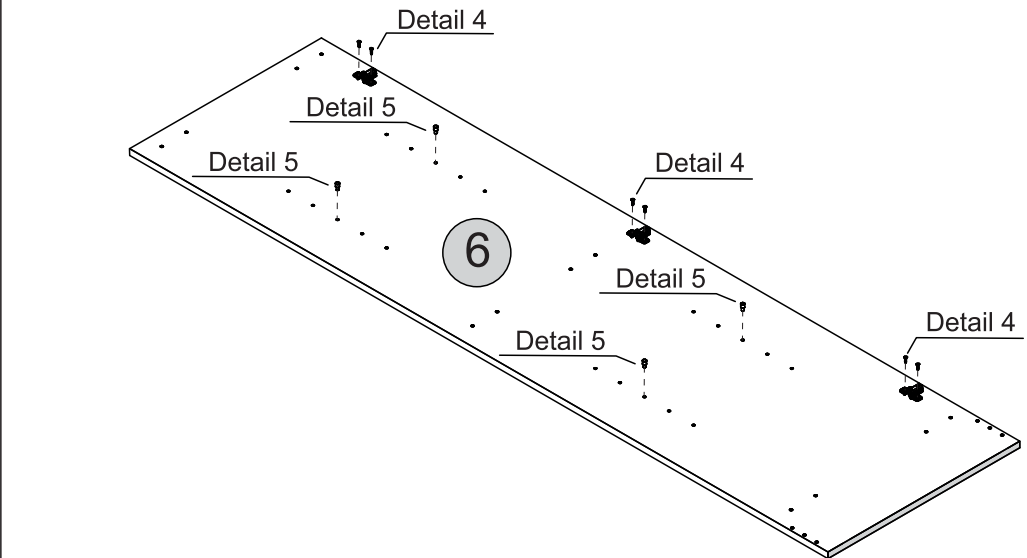
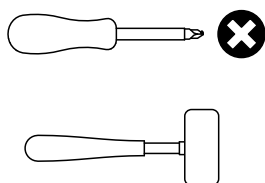

Please note:
Pre-marked
Holes

STEP 7

PARTS REQUIRED

6 - RIGHT SIDE PANEL x1

8 - FRONT BASEBOARD x1

9 - BACK BASEBOARD x1

HARDWARE REQUIRED

G  08
Ø6,0 x 30mm

H  04

L  04

V  01

TOOLS REQUIRED

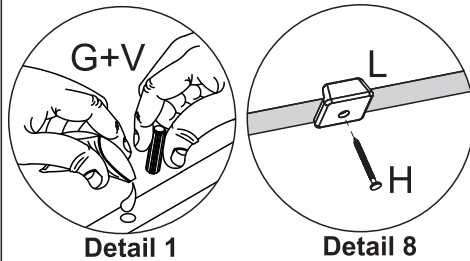
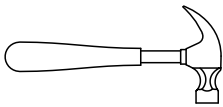

Detail 1

Detail 8

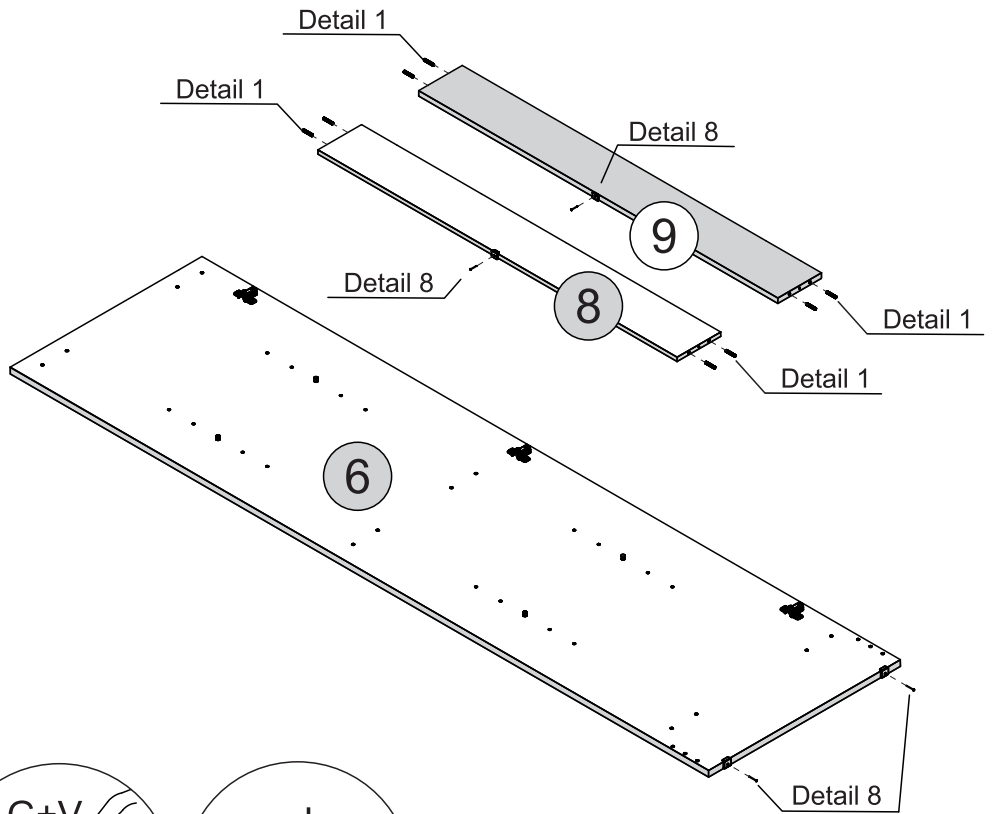

STEP 8

PARTS REQUIRED

1 - LARGE BASE PANEL x1

2 - SMALL BASE PANEL x1

4 - TOP PANEL x1

7 - SHELF x1

HARDWARE REQUIRED

G  16
Ø6,0 x 30mm

V  01

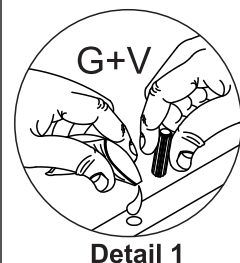

Detail 1

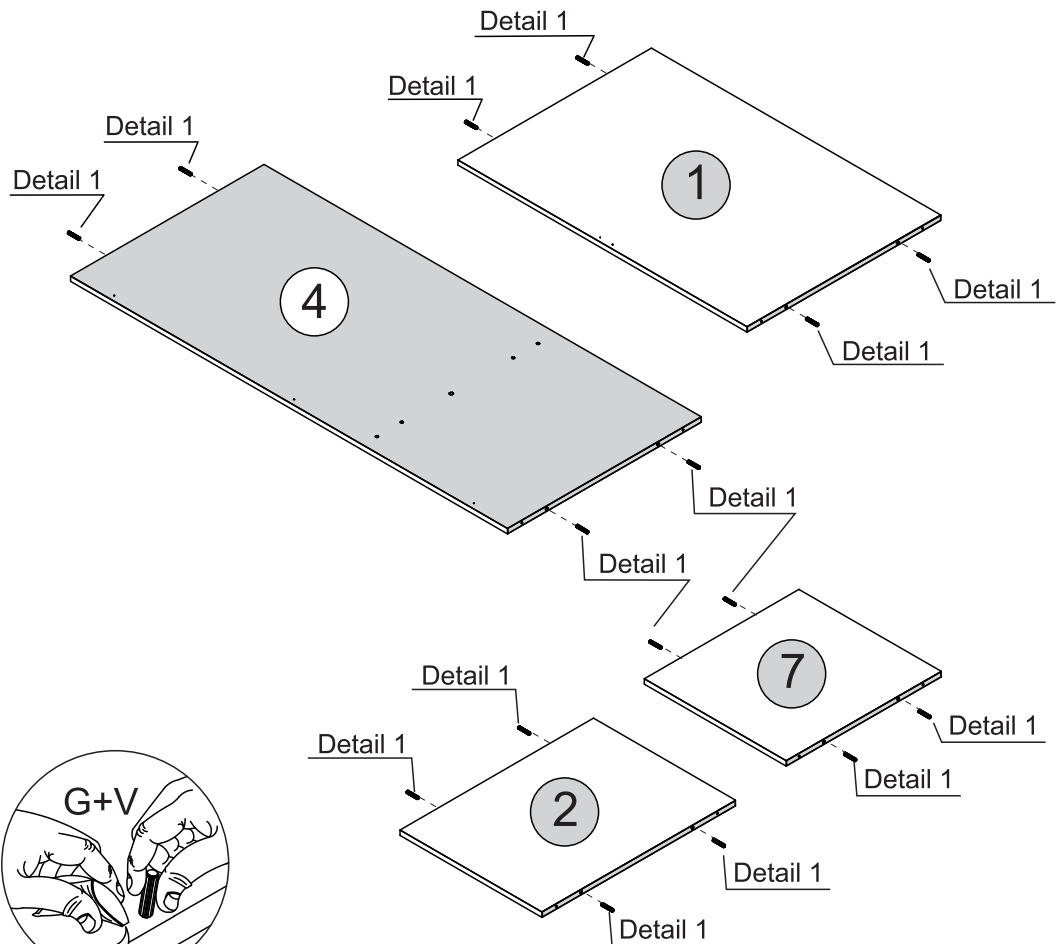

STEP 9

PARTS REQUIRED

1 - LARGE BASE PANEL x1

4 - TOP PANEL x1

HARDWARE REQUIRED

A1  07
Ø4,0 x 12mm

B1  02

J  03

TOOLS REQUIRED

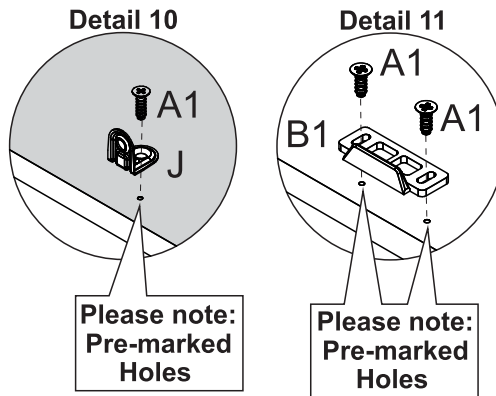
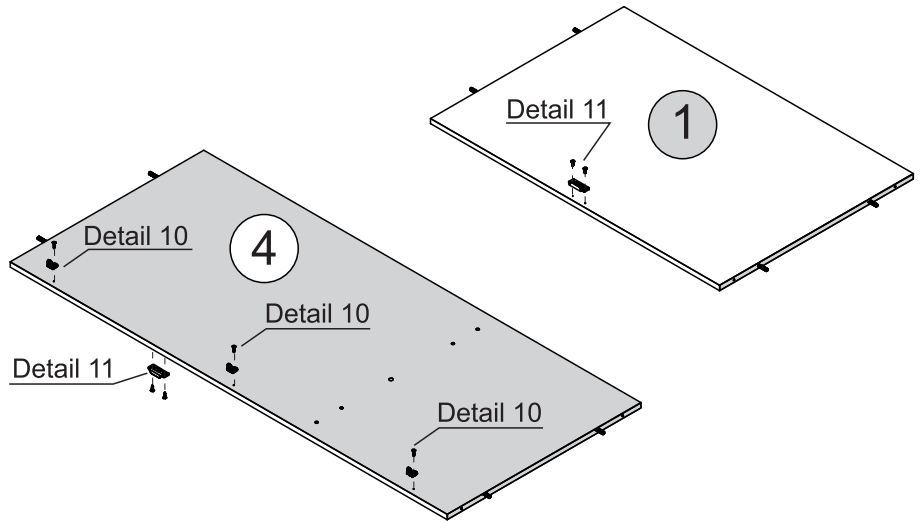
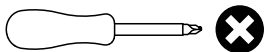

STEP 10

PARTS REQUIRED

1 - LARGE BASE PANEL x1

2 - SMALL BASE PANEL x1

3 - DIVISION PANEL x1

4 - TOP PANEL x1

HARDWARE REQUIRED

F  06
Ø4,0 x 50mm

V  01

TOOLS REQUIRED

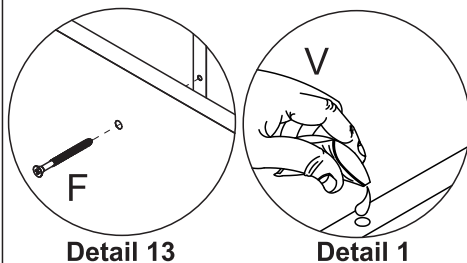
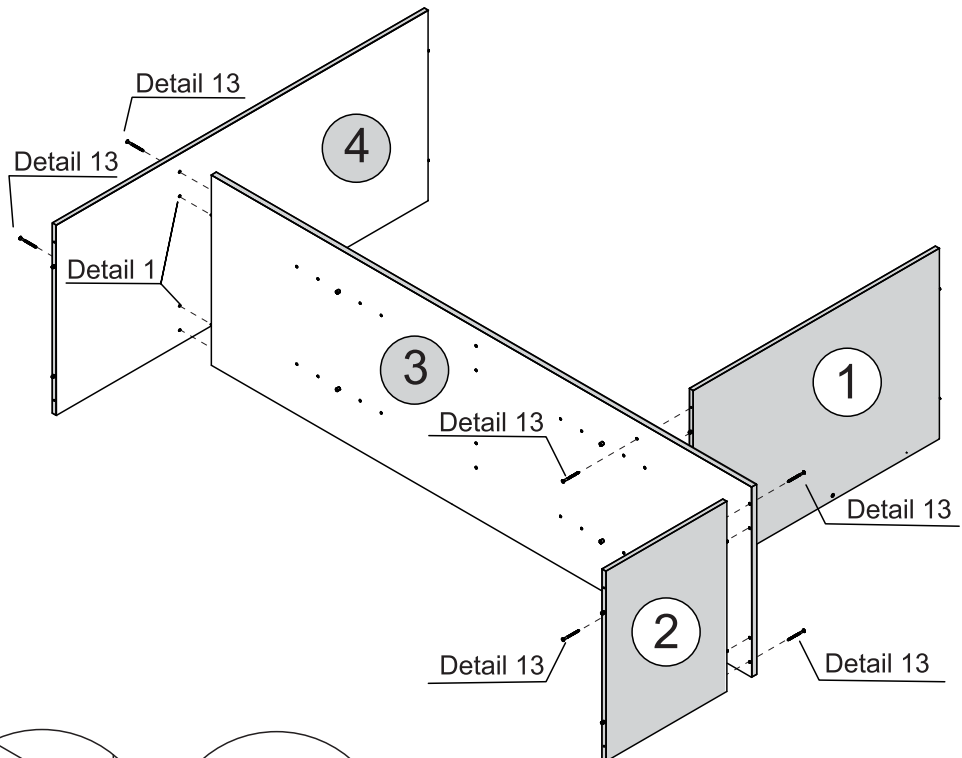
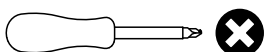

STEP 11

PARTS REQUIRED

5 - LEFT SIDE PANEL x1

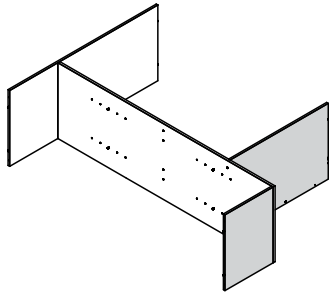

HARDWARE REQUIRED

F  Ø4,0 x 50mm 04

V  01

TOOLS REQUIRED

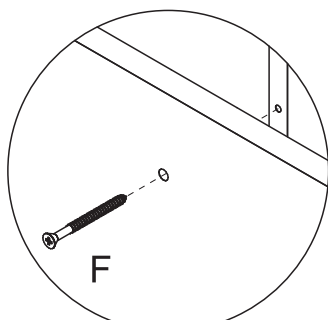
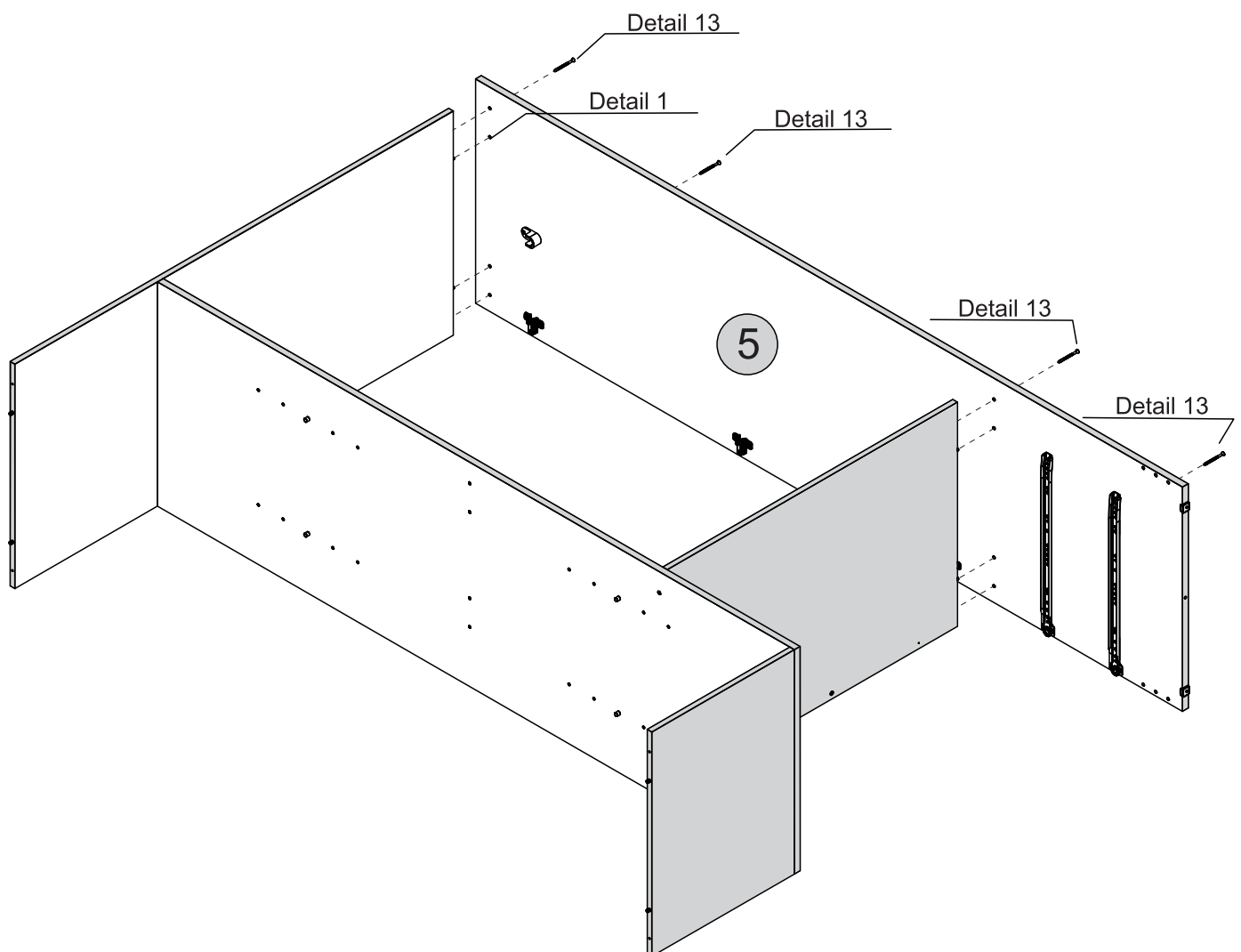
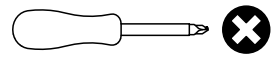

Detail 13

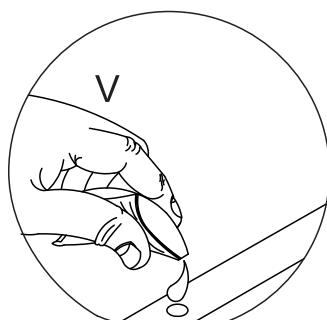



Detail 1

STEP 12

PARTS REQUIRED

6 - RIGHT SIDE PANEL	x1
7 - SHELF	x1
8 - FRONT BASEBOARD	x1
9 - BACK BASEBOARD	x1

HARDWARE REQUIRED

F	 Ø4,0 x 50mm	12
V	 Glue	01

TOOLS REQUIRED

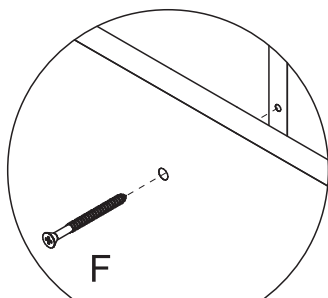
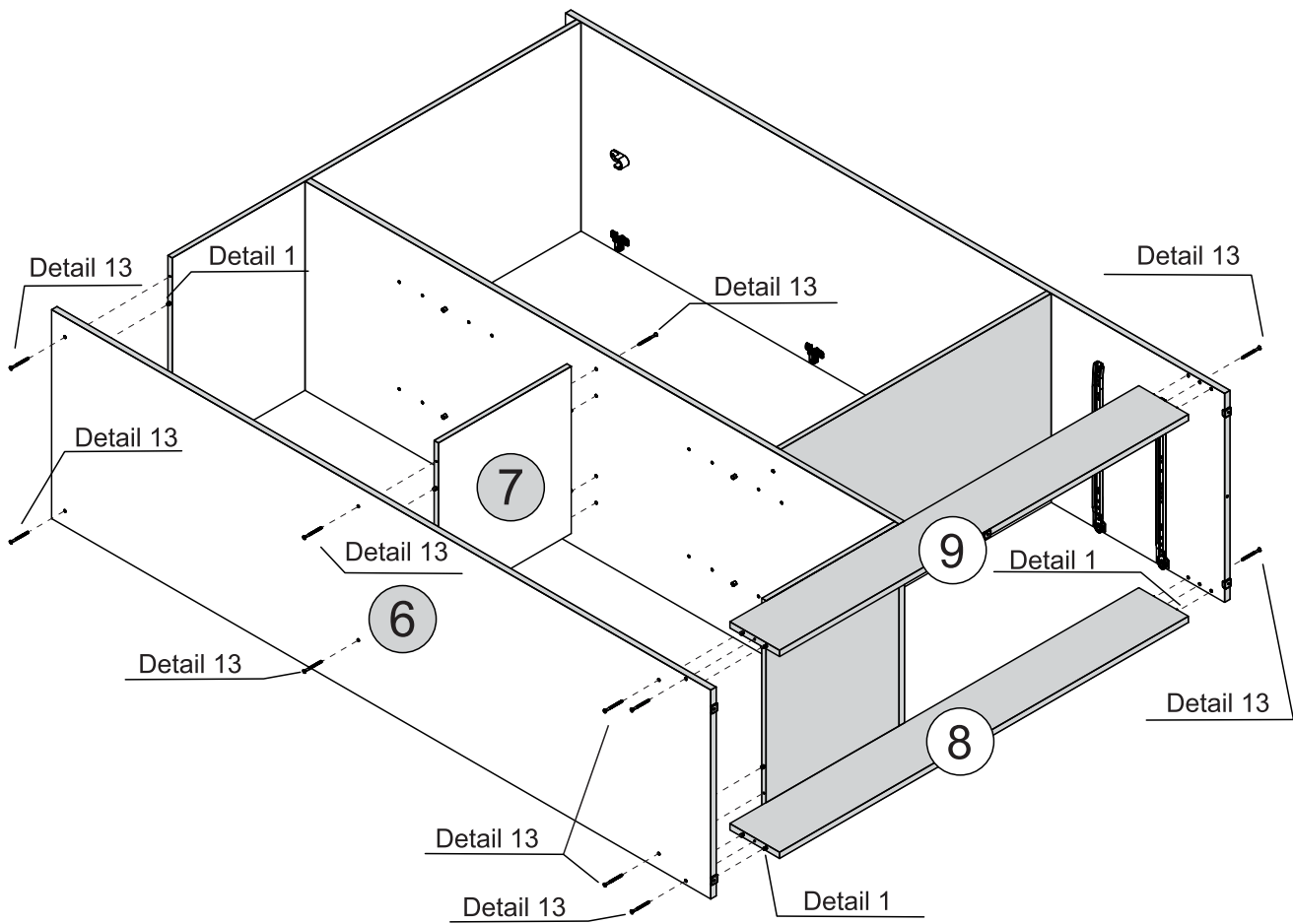
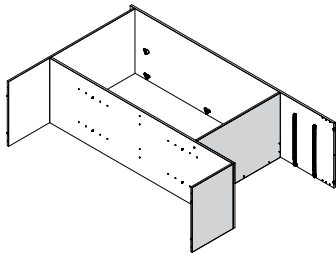
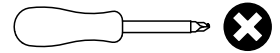

Detail 13

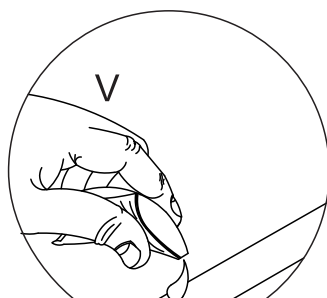

Detail 1



STEP 13

PARTS REQUIRED

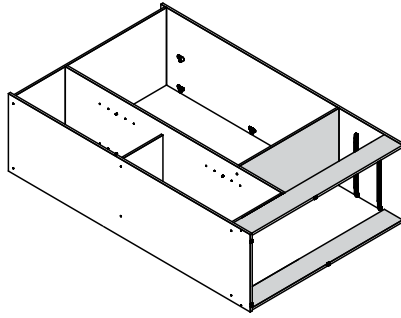
- 10 - SMALL BACK PANEL x2
- 11 - LARGE BACK PANEL x1

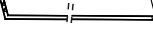

HARDWARE REQUIRED

- B  09
Ø4,0 x 14mm
- H  09
10 x 10
- R  01

TOOLS REQUIRED

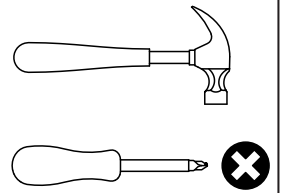

IMPORTANT PLEASE FOLLOW !

Please make sure Part 10/11 is lined up correctly at the top before placing fitting H into the panel as this can affect the alignment of the doors once assembled.

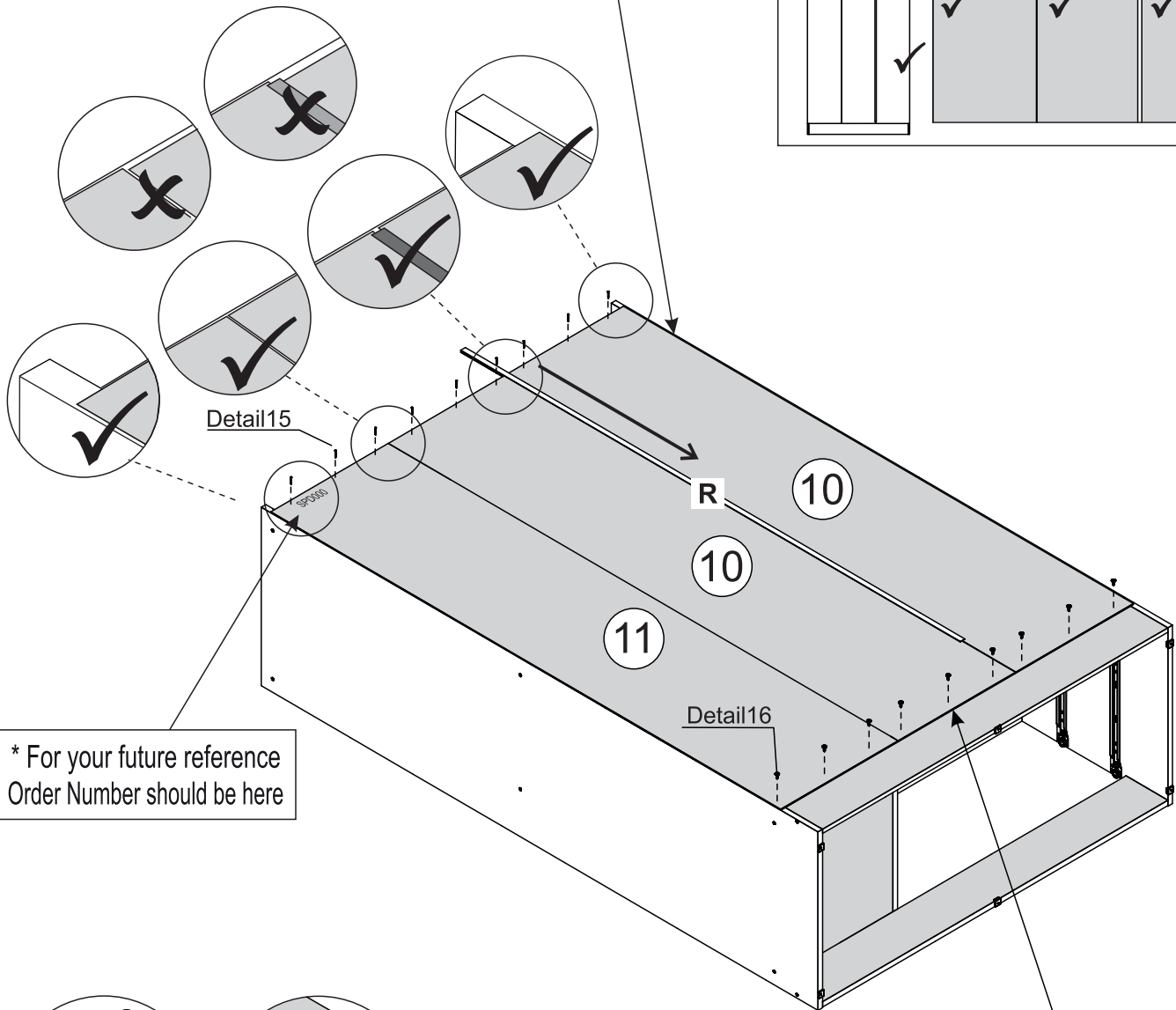
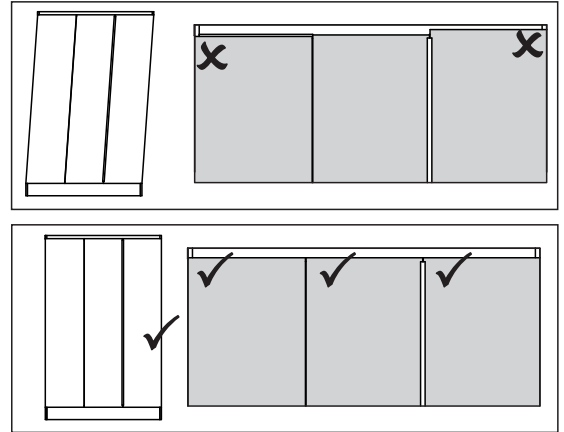

* For your future reference Order Number should be here

IMPORTANT PLEASE FOLLOW !

Please make sure Part 10/11 isn't overhanging at the sides before you screw fitting B into the plinth.

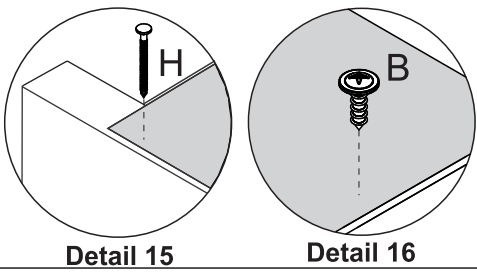

STEP 14

PARTS REQUIRED

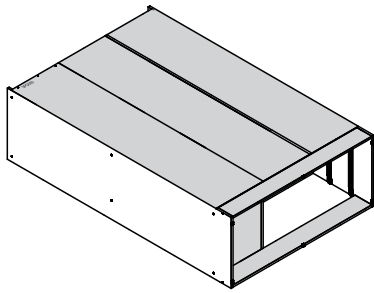

HARDWARE REQUIRED

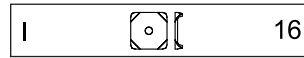
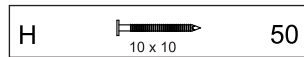

TOOLS REQUIRED

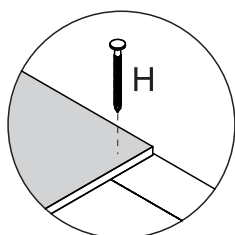
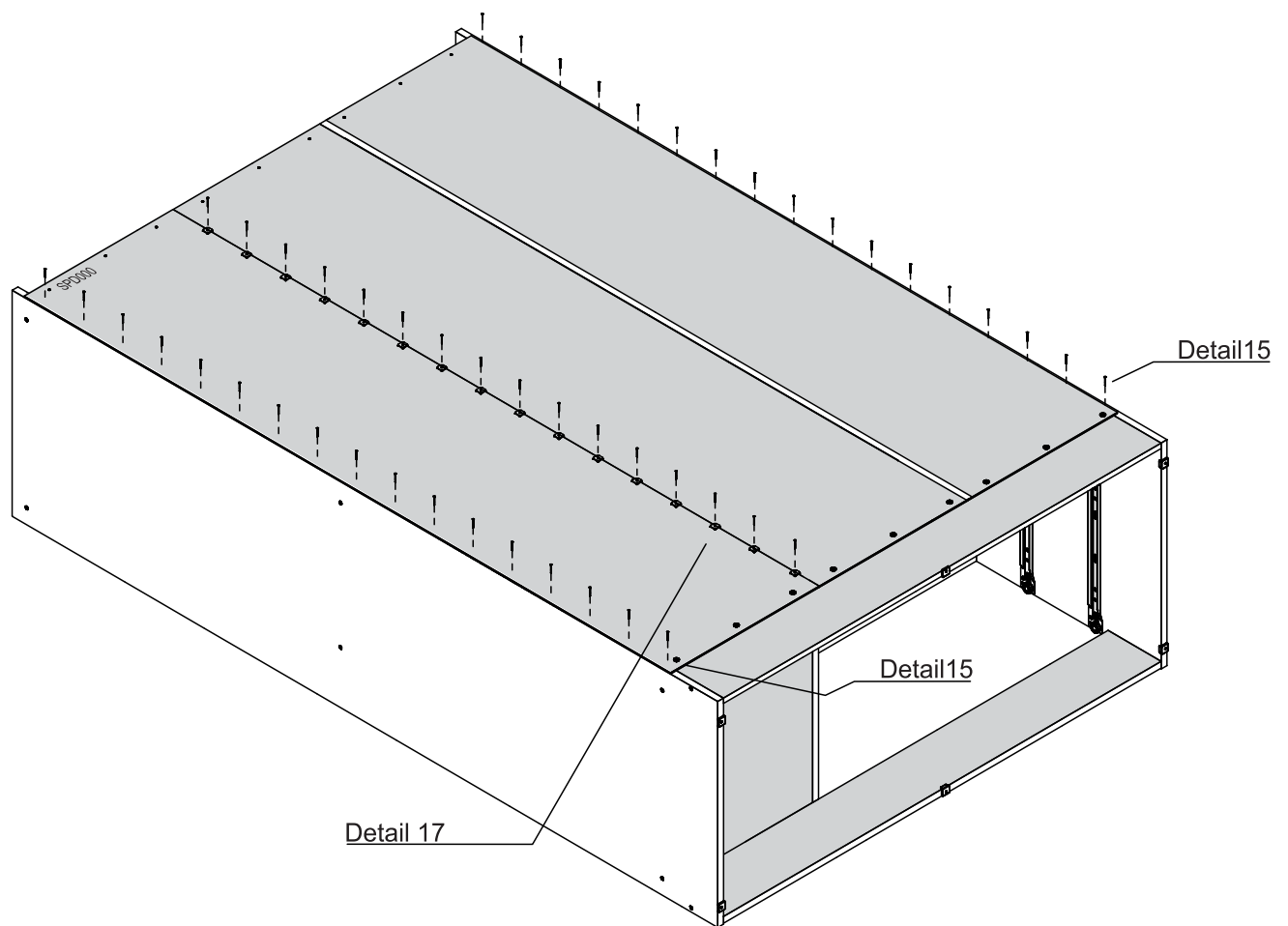
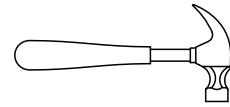

Detail 15

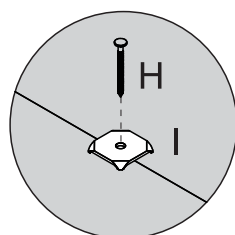

Detail 17

STEP 15

PARTS REQUIRED

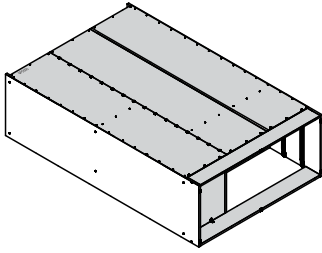

HARDWARE REQUIRED

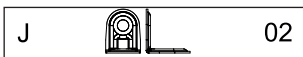
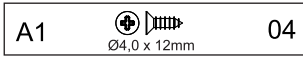
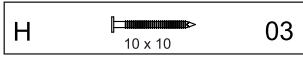

TOOLS REQUIRED

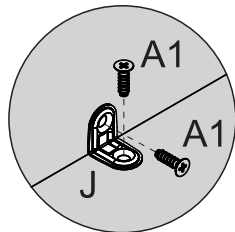
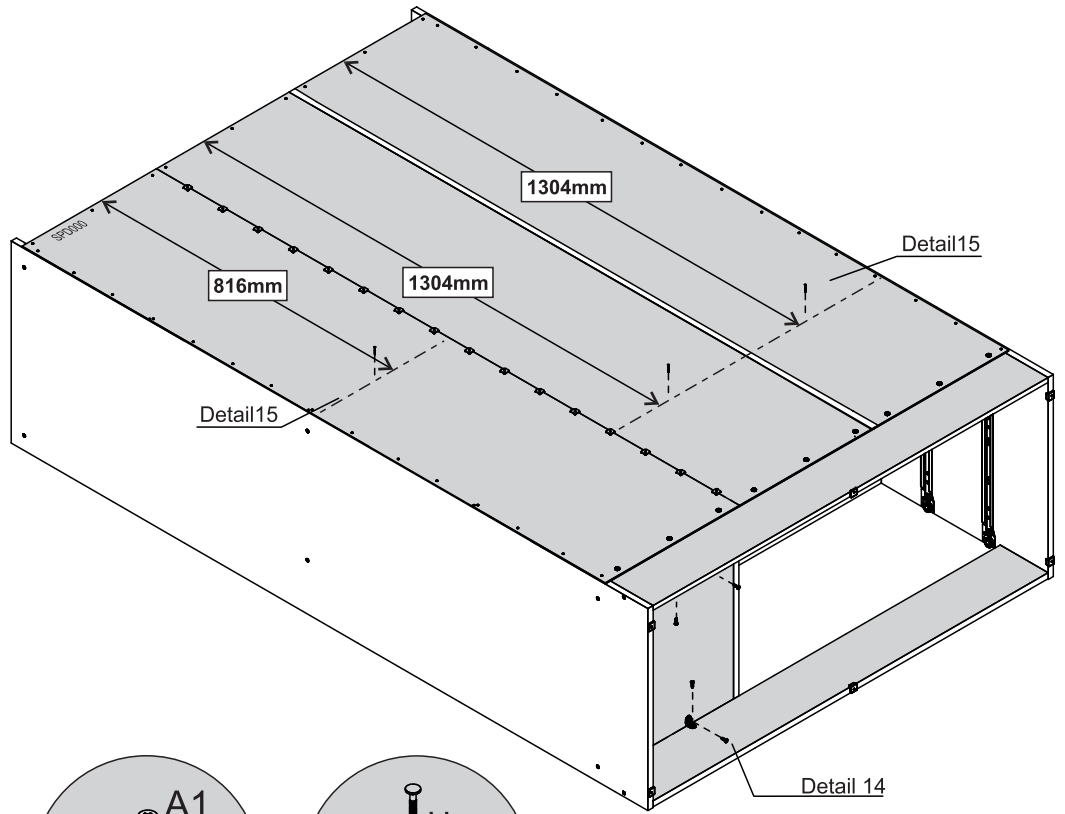
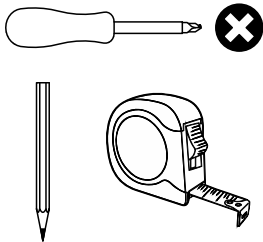

Detail 14

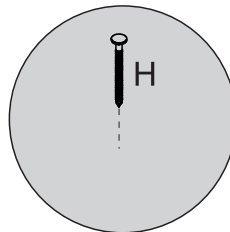

Detail 15

STEP 16

PARTS REQUIRED

12 - FRAME x1

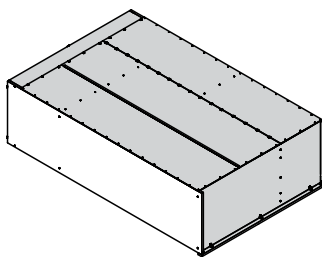

HARDWARE REQUIRED

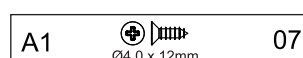

TOOLS REQUIRED

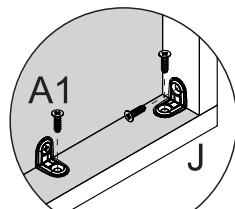
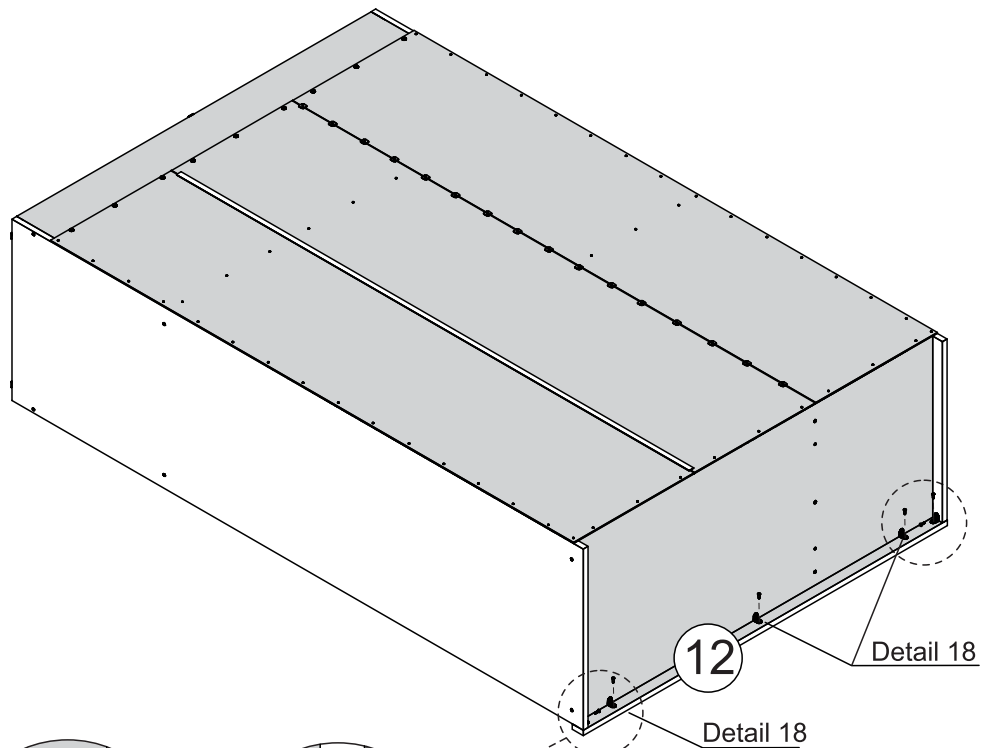
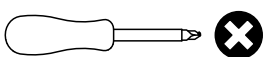

Detail 18

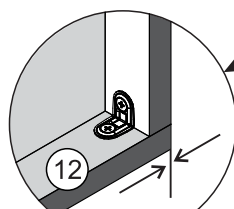



Align corners

STEP 17

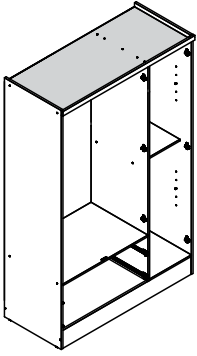
PARTS REQUIRED



HARDWARE REQUIRED

N		01
C1		04

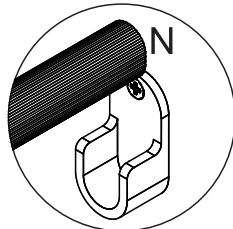
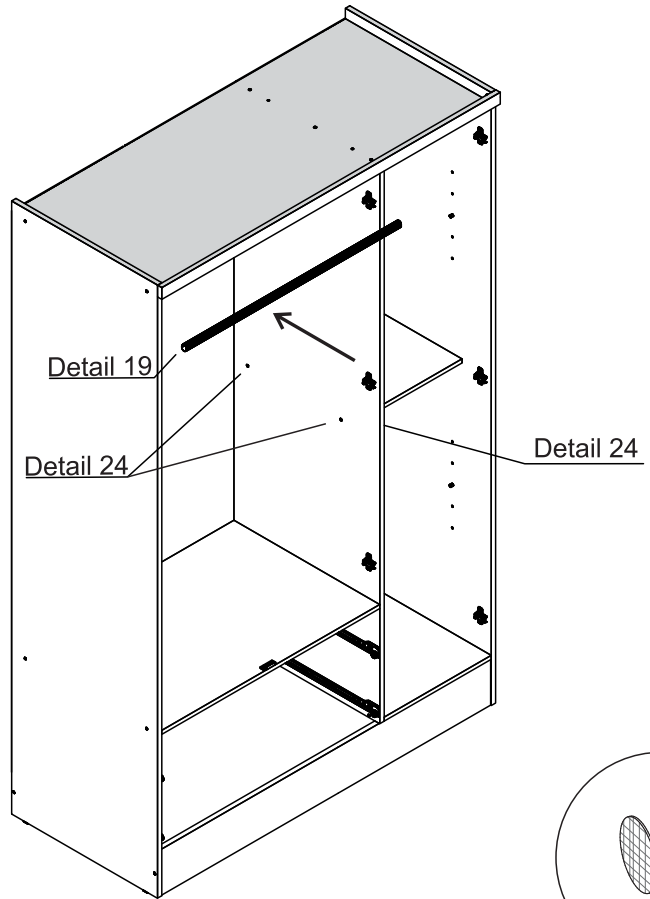

Detail 19

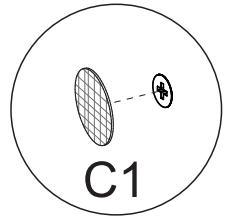



Detail 24

STEP 18

PARTS REQUIRED

16 - DRAWER SIDE	x4
17 - DRAWER BACK PANEL	x2
20 - DRAWER BOTTOM SUPPORT BARx2	

HARDWARE REQUIRED

G		20
V		01

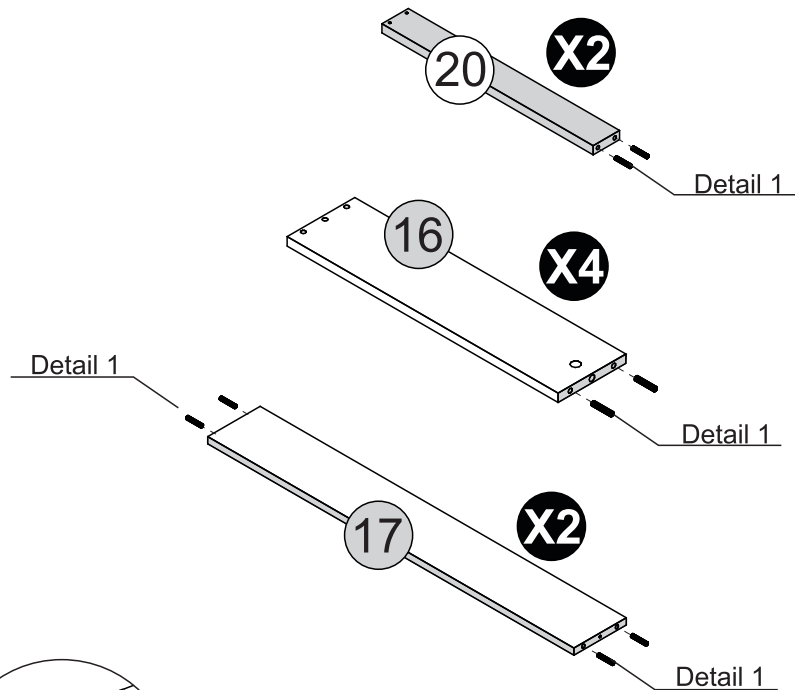

Detail 1

STEP 19

PARTS REQUIRED

18 - DRAWER FRONT x2

HARDWARE REQUIRED

X  04

TOOLS REQUIRED

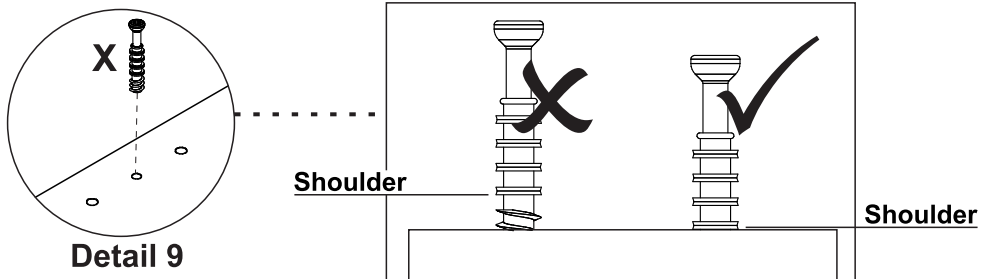
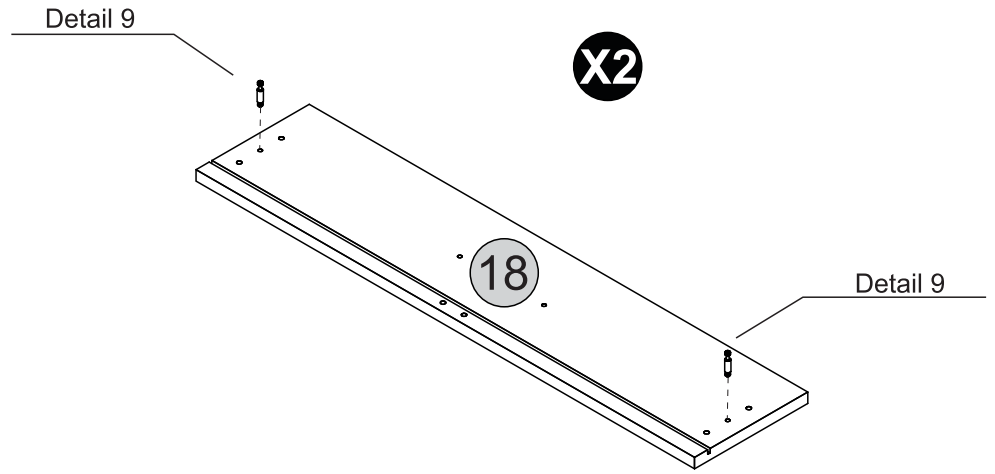
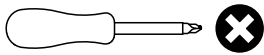

STEP 20

PARTS REQUIRED

16 - DRAWER SIDE x4

17 - DRAWER BACK PANEL x2

HARDWARE REQUIRED

F  Ø4,0 x 50mm 04

TOOLS REQUIRED

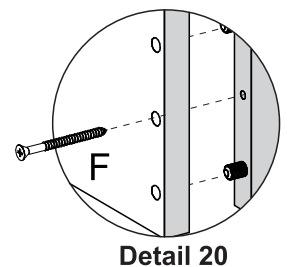
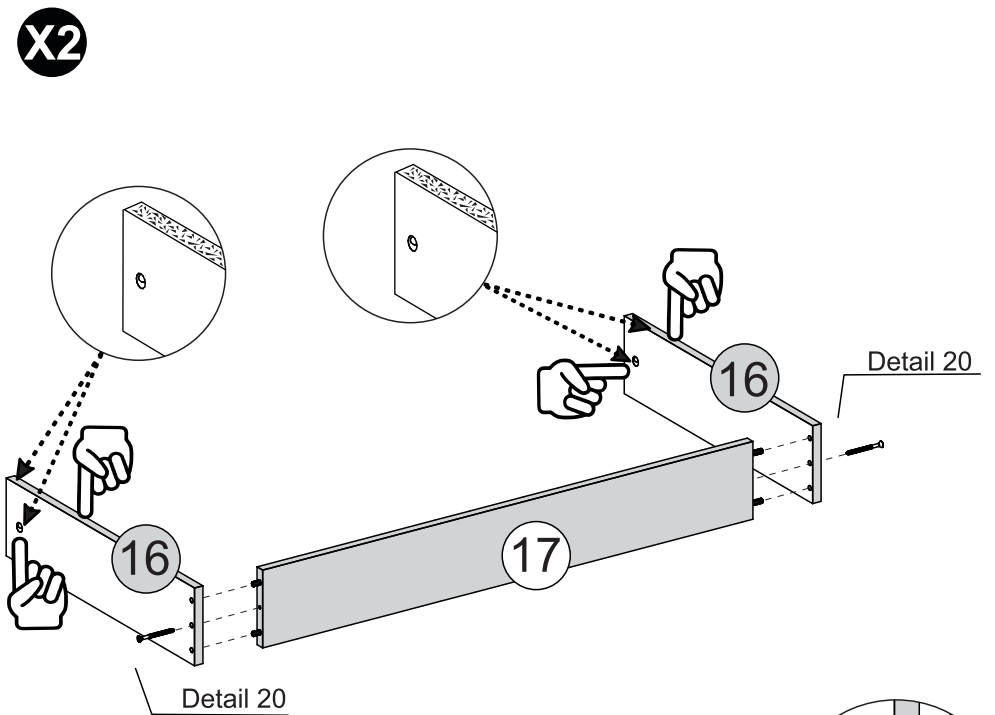
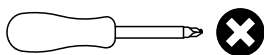

STEP 21

PARTS REQUIRED

18 - DRAWER FRONT x2

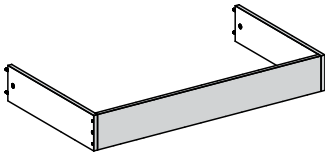

HARDWARE REQUIRED

V  01

W  04

C1  04

TOOLS REQUIRED

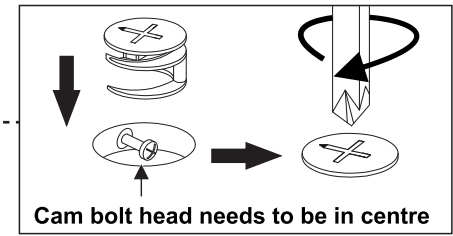
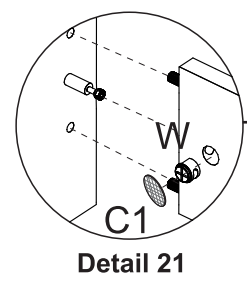
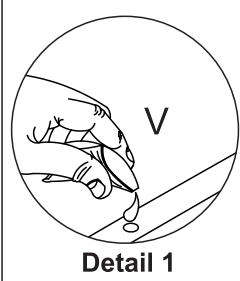
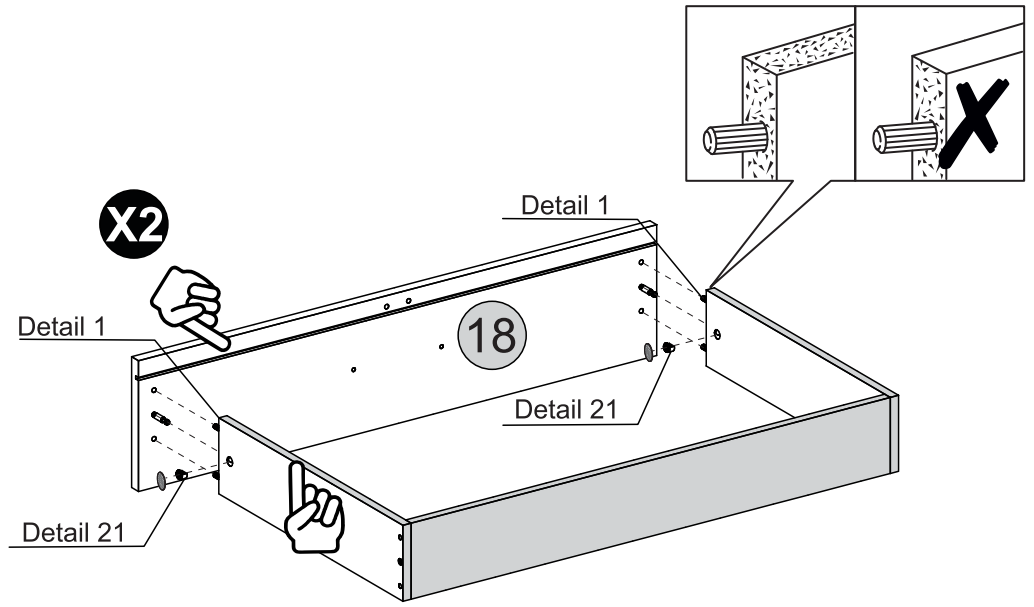
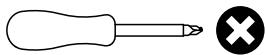

STEP 22

PARTS REQUIRED

19 - DRAWER BOTTOM x2

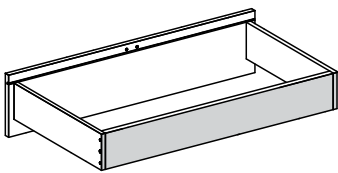

HARDWARE REQUIRED

H  10 x 10 08

TOOLS REQUIRED

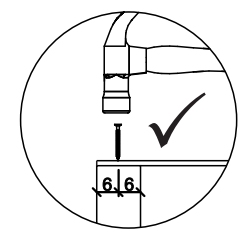
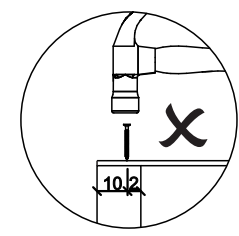
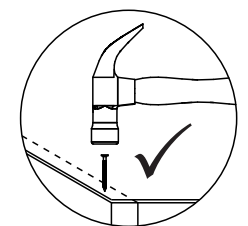
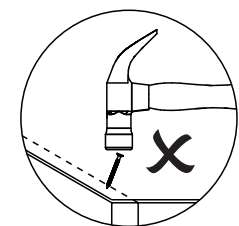
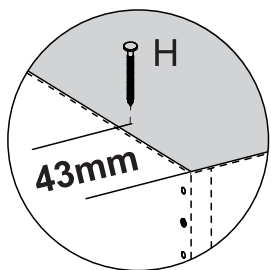
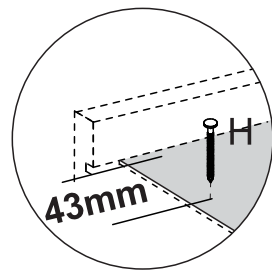
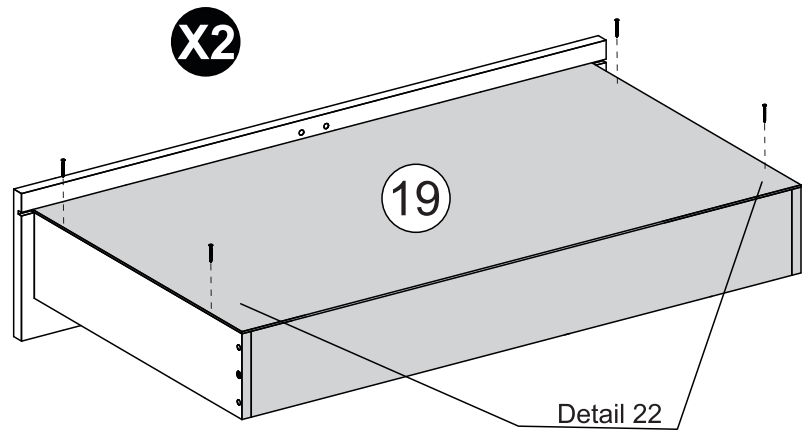
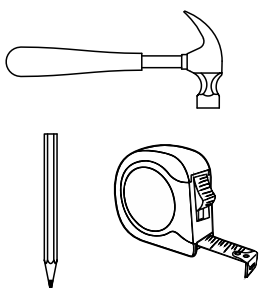

STEP 23

PARTS REQUIRED

20 - DRAWER BOTTOM SUPPORT BAR x2

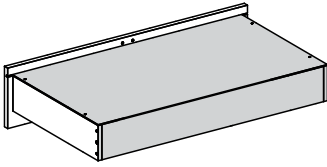

HARDWARE REQUIRED

H  12
10 x 10

V  01
Glue

TOOLS REQUIRED

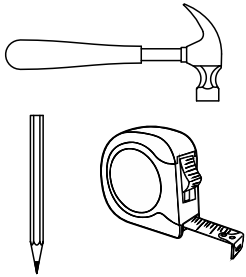

X2

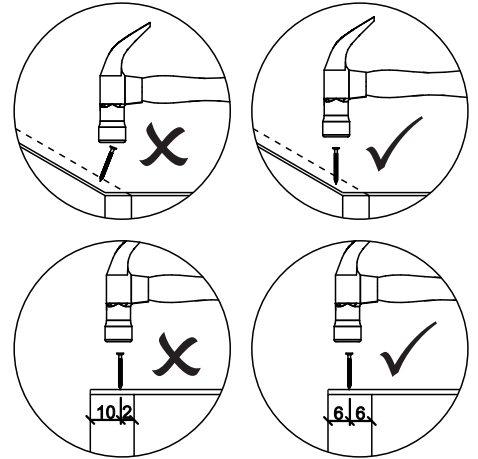
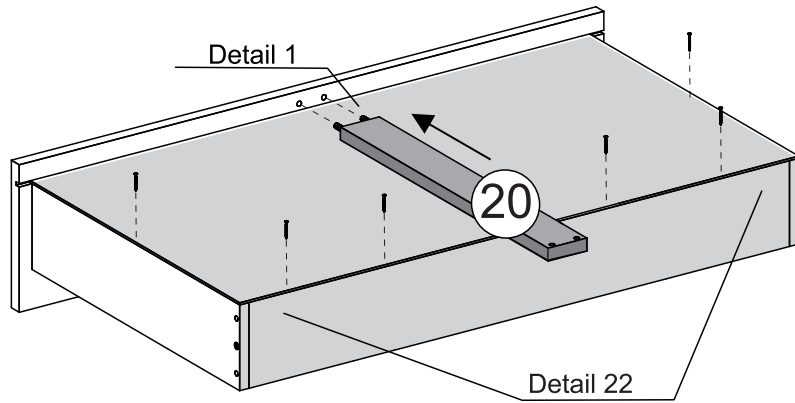

Detail 1

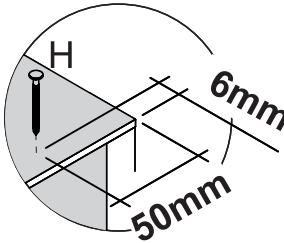

Detail 22

STEP 24

PARTS REQUIRED

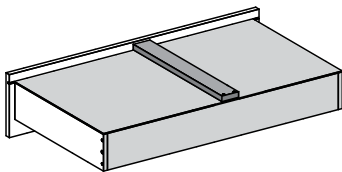

HARDWARE REQUIRED

C  08
Ø4,0 x 14mm

E  04
Ø3,5 x 40mm

Q  02
LEFT

Q  02
RIGHT

TOOLS REQUIRED

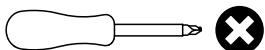

X2

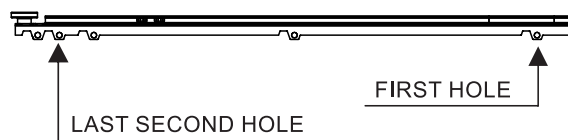
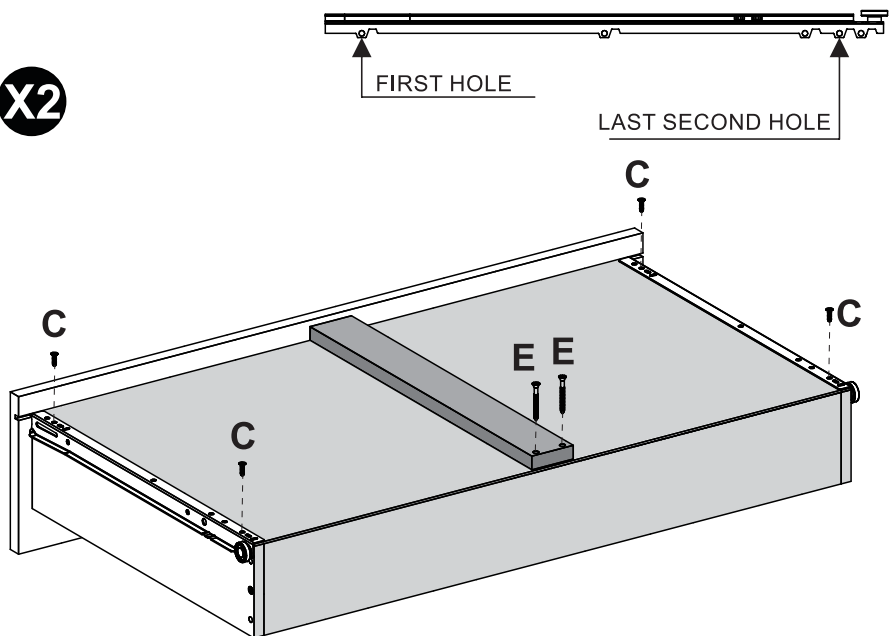

STEP 25

PARTS REQUIRED

13 - LARGE DOOR x1

14 - RIGHT SMALL DOOR x1

15 - LEFT SMALL DOOR x1

HARDWARE REQUIRED

C  18
Ø4,0 x 14mm

O  09

TOOLS REQUIRED

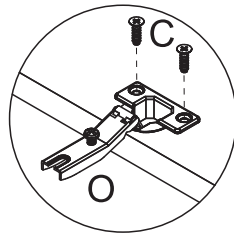
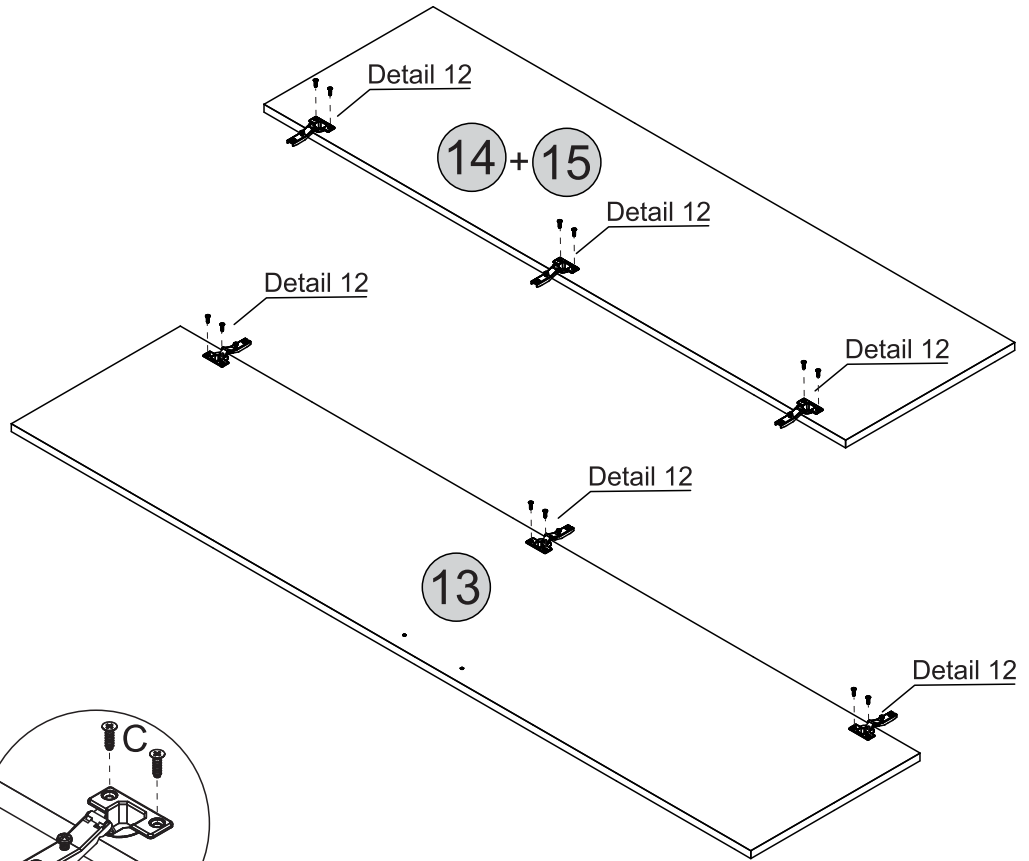
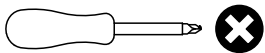

Detail 12

STEP 26

PARTS REQUIRED

13 - LARGE DOOR x1

14 - RIGHT SMALL DOOR x1

15 - LEFT SMALL DOOR x1

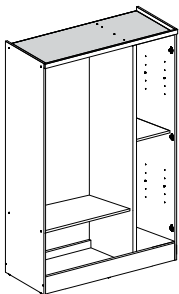

HARDWARE REQUIRED

U  14

TOOLS REQUIRED

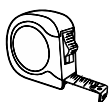
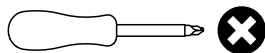

!
Please note the top or bottom edges of the doors are labelled LEFT or RIGHT to make them easier to identify when assembling.

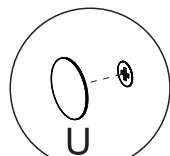
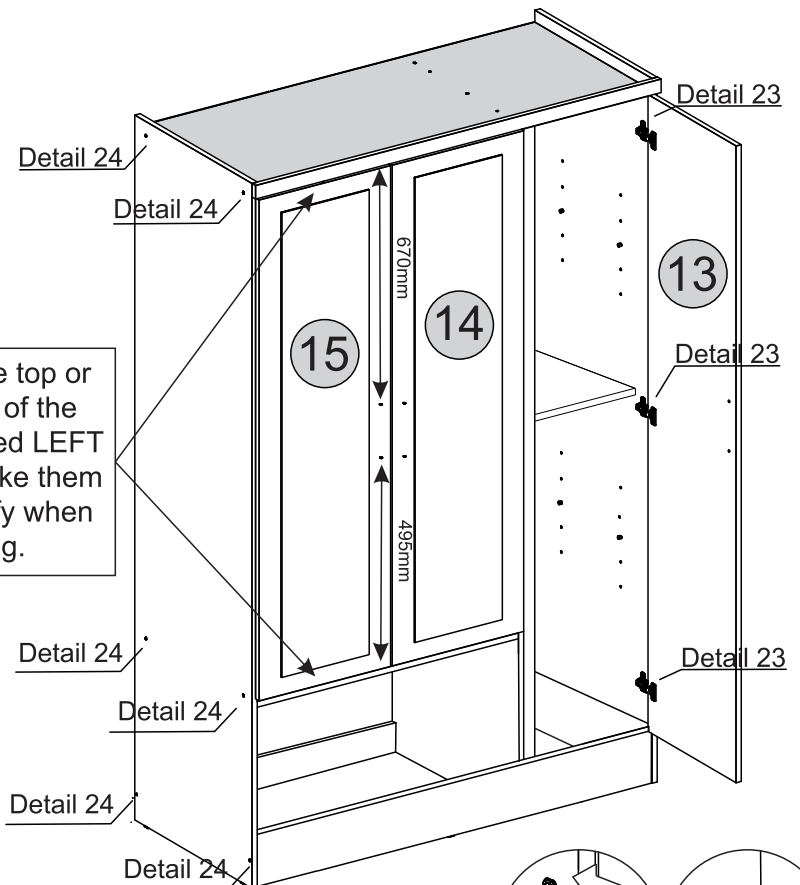

Detail 24

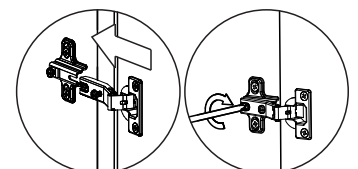

Detail 23

STEP 27

PARTS REQUIRED

21 - MOVEABLE SHELF x2

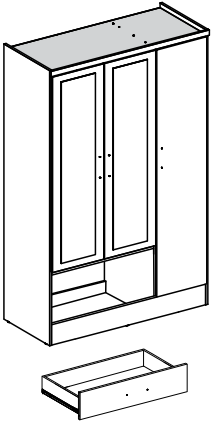

HARDWARE REQUIRED

D  10
Ø4,0 x 20mm

T  05

TOOLS REQUIRED

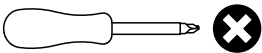

TIP
If desired, after assembly use an alcohol cleaner to erase the number printed on the parts.

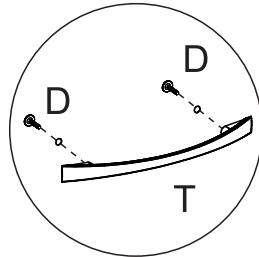
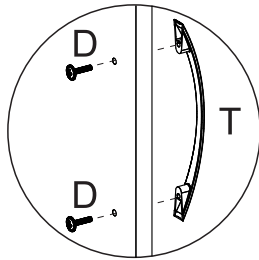
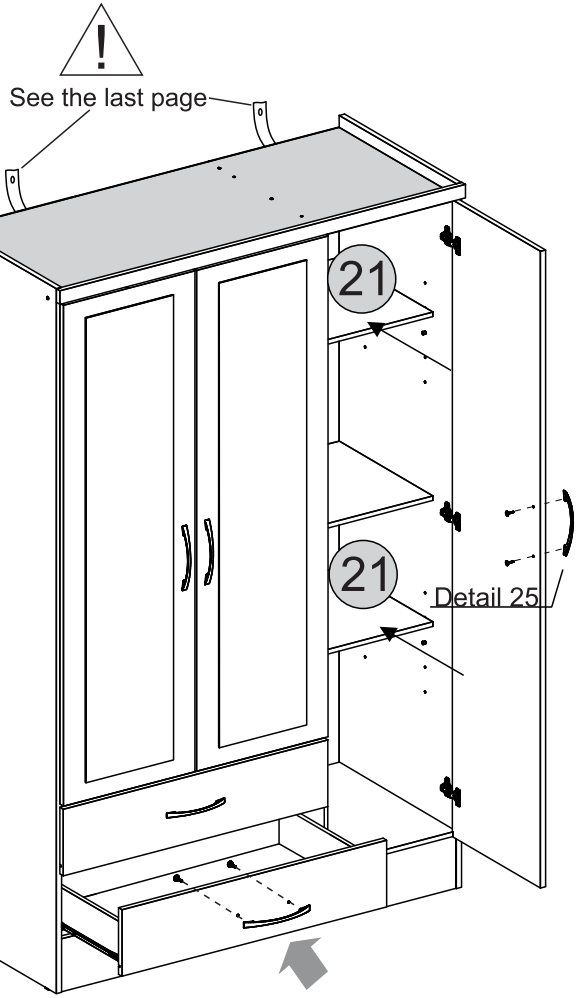

Detail 25

STEP 28

PARTS REQUIRED

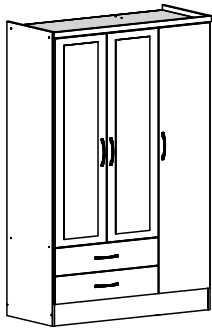

HARDWARE REQUIRED

C  04
Ø4,0 x 14mm

TOOLS REQUIRED

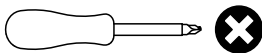

Height Adjustment

Internal Adjustment

Depth Adjustment

Drawer Adjustment

Drawer Lock

Detail 26

WARNING

Serious or fatal injuries can occur from furniture tipping over. To prevent the furniture from tipping over we recommend that it is permanently fixed to the wall.

Wall fixings are not supplied with this product as different wall materials require different types of fixing devices.

Please make sure you use fixings suitable for the walls in your home.

