

# NEVADA 2 DOOR SLIDER WARDROBE ASSEMBLY INSTRUCTIONS

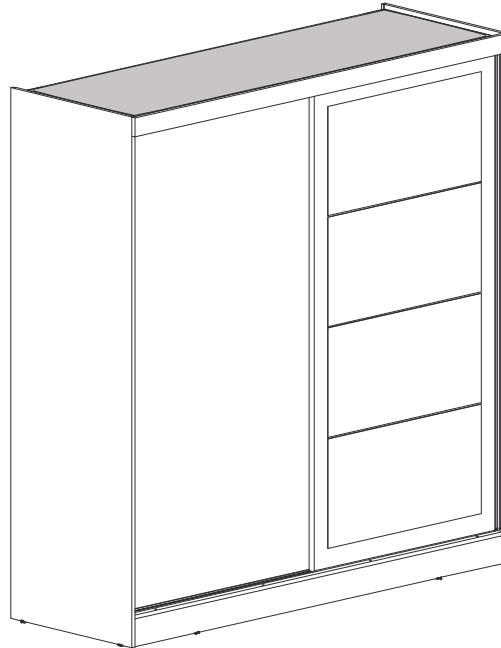
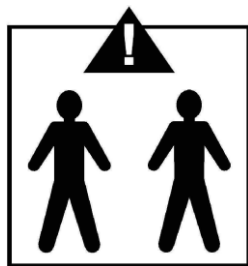

## IMPORTANT FOR DOMESTIC USE ONLY

PLEASE READ BEFORE YOU CONTINUE FURTHER

## CARE AND MAINTENANCE

After unpacking this product please keep the original packaging in case it needs to be returned for any reason.

- Please ensure all fittings and parts are present before commencing with assembly.
- Never drag or push products as this could cause damage to the joints making it inferior.
- We strongly recommend that you keep children away from your work area.
- We recommend that you lay a blanket or sheet on the floor to avoid damage to both your floor and the product.
- Assemble this product as close to its final position as possible.
- Do not place this product next to a radiator or in direct sunlight.
- Do not drag or push items across your high gloss furniture as this may cause the surface to scratch
- Wood is a natural product and may expand if subjected to damp and may shrink or crack if subjected to heat. Therefore it is recommended that room temperature is maintained, with no sudden temperature fluctuations.
- Make sure any spillage is wiped off immediately.
- Do not place hot or chilled items directly on to the surface, use a place mat or marking will occur.
- For general cleaning use a soft cotton or micro fibre cloth, and do not use detergents of any kind.
- From time to time it may be necessary to tighten fittings, regular inspections should be carried out.
- Do not place on a wet or damp floor as staining may occur to your floor.

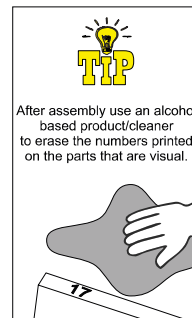
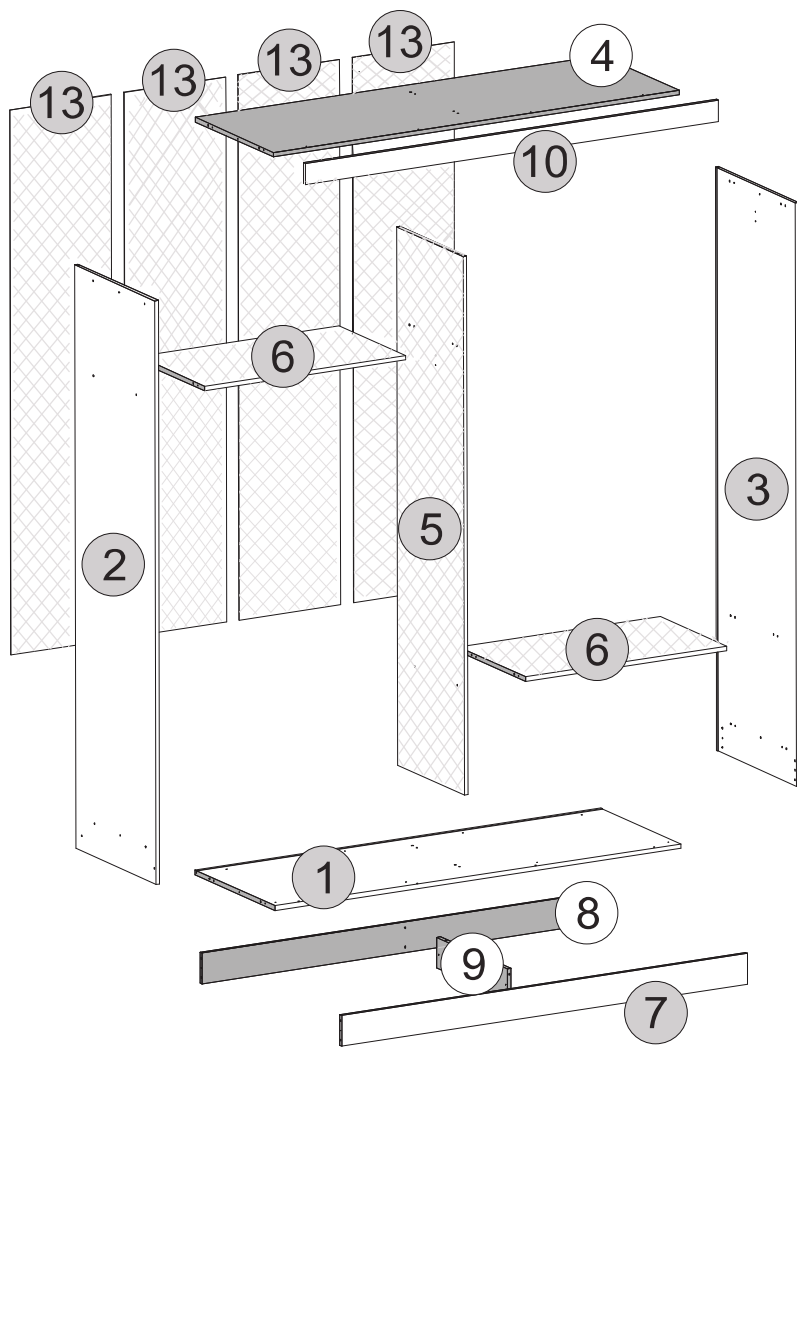



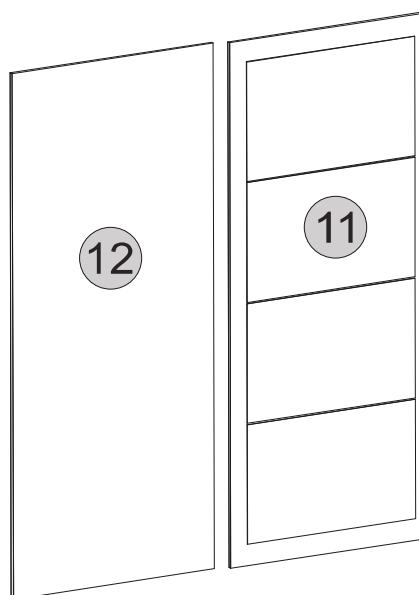
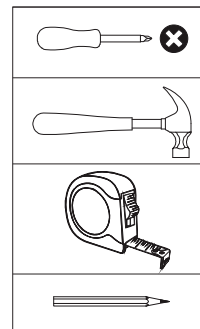











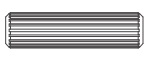



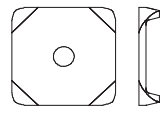
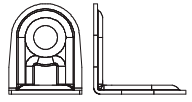

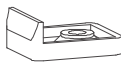



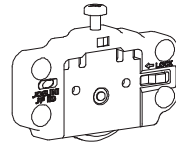

**TOOLS REQUIRED**

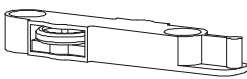

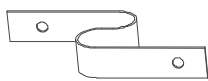
**Please Note:**  
The below parts have all been stamped with the part number to help identify them during assembly.

Part Number	Part Description	Quantity	Carton
1	Base Panel	1	1/3
2	Left Side	1	2/3
3	Right Side	1	2/3
4	Top Panel	1	1/3
5	Division Panel	1	2/3
6	Shelf	2	1/3
7	Front Baseboard	1	1/3
8	Back Baseboard	1	1/3
9	Crossbeam	1	1/3
10	Frame	1	2/3
11	Mirrored Door	1	3/3
12	Door	1	3/3
13	Back Panel	4	2/3

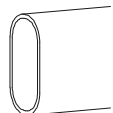
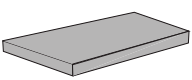
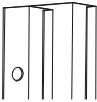
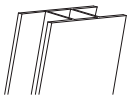

# FITTINGS LIST

<b>A</b> x 4  <b>Cam Bolt 32xØ6mm</b> 1/+	<b>B</b> x 4  <b>Can Nut Ø15 mm</b> 1/+	<b>C</b> x 28  <b>Screw Ø4 x 14 mm</b> 2/+	<b>D</b> x 34  <b>Triangle Support Angle</b> 2/+	<b>E</b> x 30  <b>Dowel Ø6 x 30 mm</b> 2/+
<b>F</b> x24  <b>Screw Ø4 x 50 mm</b> 2/+	<b>G</b> x 1  <b>Glue 10g</b> 1/+	<b>H</b> x 45  <b>Nail 10x10</b> 2/+	<b>I</b> x 11  <b>Back Panel Bracket</b> 2/+	<b>J</b> x 10  <b>Metalic Support 18x18 "L"</b> 1/+
<b>K</b> x 4  <b>Washer Ø16x7 mm</b> 1/+	<b>L</b> x 10  <b>Plastic Foot L 19x17x8mm Ø2mm</b> 2/+	<b>M</b> x 4  <b>Support Pipe Oblongo Plastic</b>	<b>N</b> x 2  <b>Screw Ø3,5 x 30 mm</b> 1/+	<b>O</b> x 24  <b>Screw Ø3,5 x 14mm</b> 2/+
<b>P</b> x 34  <b>Screw Ø3 x 16 mm</b> 2/+	<b>Q</b> x28  <b>Hole Plugs 19mm</b> 2/+	<b>R</b> x 8  <b>Screw Ø3.5 x 35 mm</b> 1/+	<b>B1</b> SLIDING SYSTEM KIT x2  Lower Pulley x4  Sliding System Brake x4  Upper Pulley x4  Screw Ø3.5 x 16 mm x28 (2/+)	
<b>S</b> x 2  <b>Strap 200x20x1mm</b>	<b>T</b> x 2  <b>Dowel Ø6 x 70 mm</b> 1/+	<b>U</b> x 12  <b>Silicone Drop Ø6x2mm</b>	<b>V</b> x 1  <b>Lower Rail 1754x42x5mm</b> Cart. 1/3	<b>W</b> x 2  <b>Hanging Rail 861x27x16 mm</b> Cart. 1/3
<b>Y</b> x1  <b>Gabarito MDF 80x29x3mm</b>	<b>Z</b> x 2  <b>Handle Profile 1760x38x16mm</b> Cart. 2/3	<b>A1</b> x 2  <b>Back Panel Strip H 1787x19x7mm</b> Cart. 2/3	<b>C1</b> x 8  <b>Hole Plugs Lineo 19mm</b> 2/+	

## TIPS FOR FITTINGS CAM-LOCKS

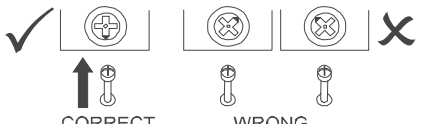
WHEN FITTING CAM NUT, ENSURE STARTING POSITION IS CORRECT BEFORE YOU INSERT CONNECTING CAM BOLT TURN CLOCKWISE UNTIL SECURE



 CORRECT  
 WRONG

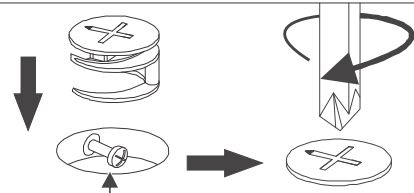

Cam bolt head needs to be in centre

### CAMBOLT

Tighten until shoulder in flush with panel. Do not overtighten or undertighten (see example beside)

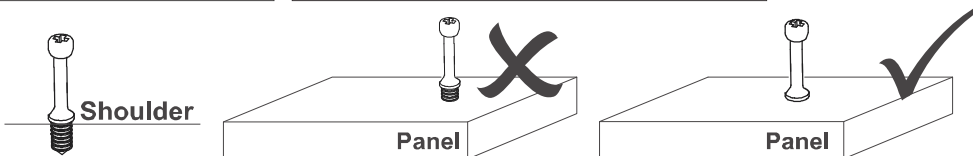





# STEP 1

## PARTS REQUIRED

7 - FRONT BASEBOARD	x1
8 - BACK BASEBOARD	x1
9 - CROSSBEAM	x1

## HARDWARE REQUIRED

C		02
H		06
J		02
L		06

## TOOLS REQUIRED

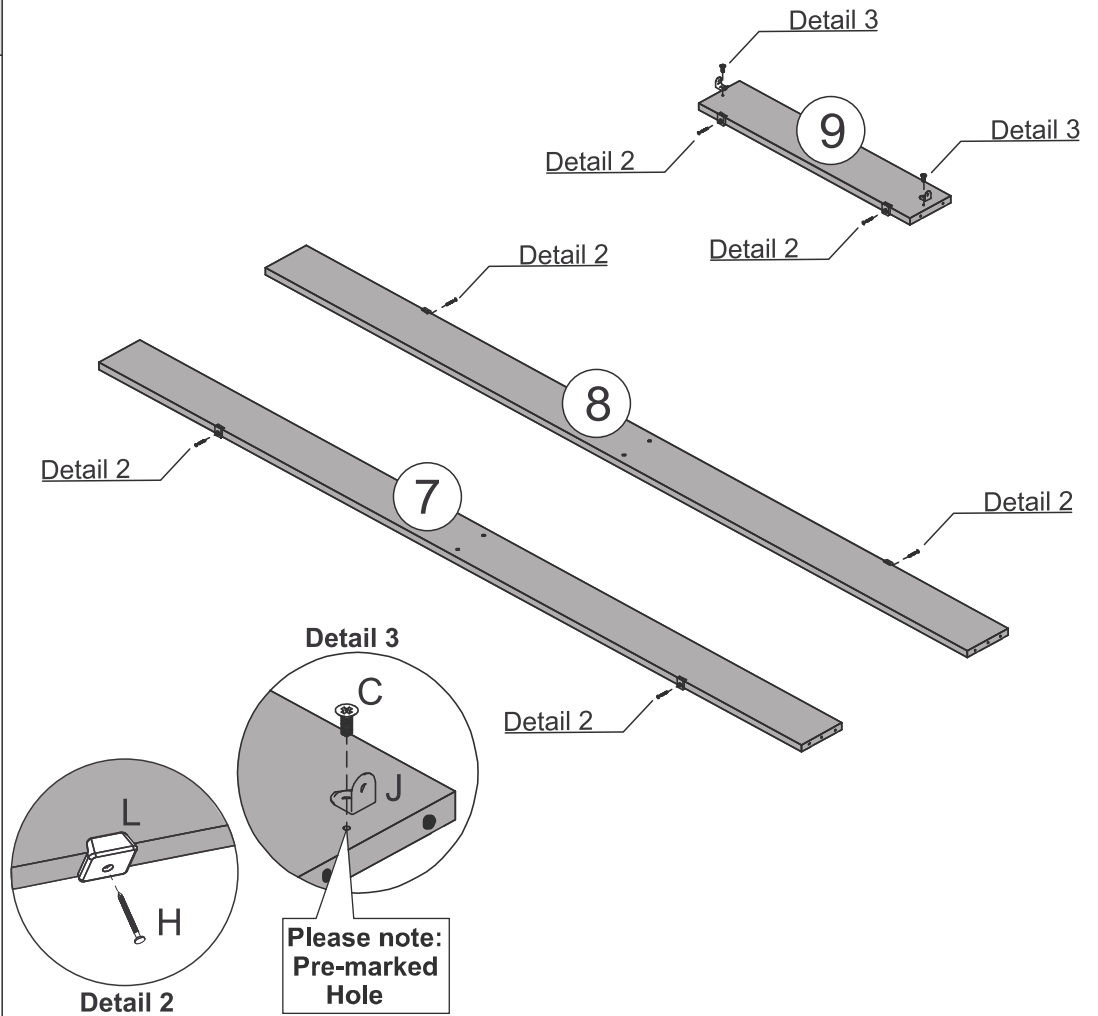
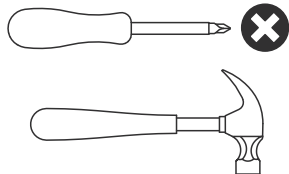



# STEP 2

## PARTS REQUIRED

7 - FRONT BASEBOARD	x1
8 - BACK BASEBOARD	x1
9 - CROSSBEAM	x1

## HARDWARE REQUIRED

E		12
G		01
T		02

## TOOLS REQUIRED

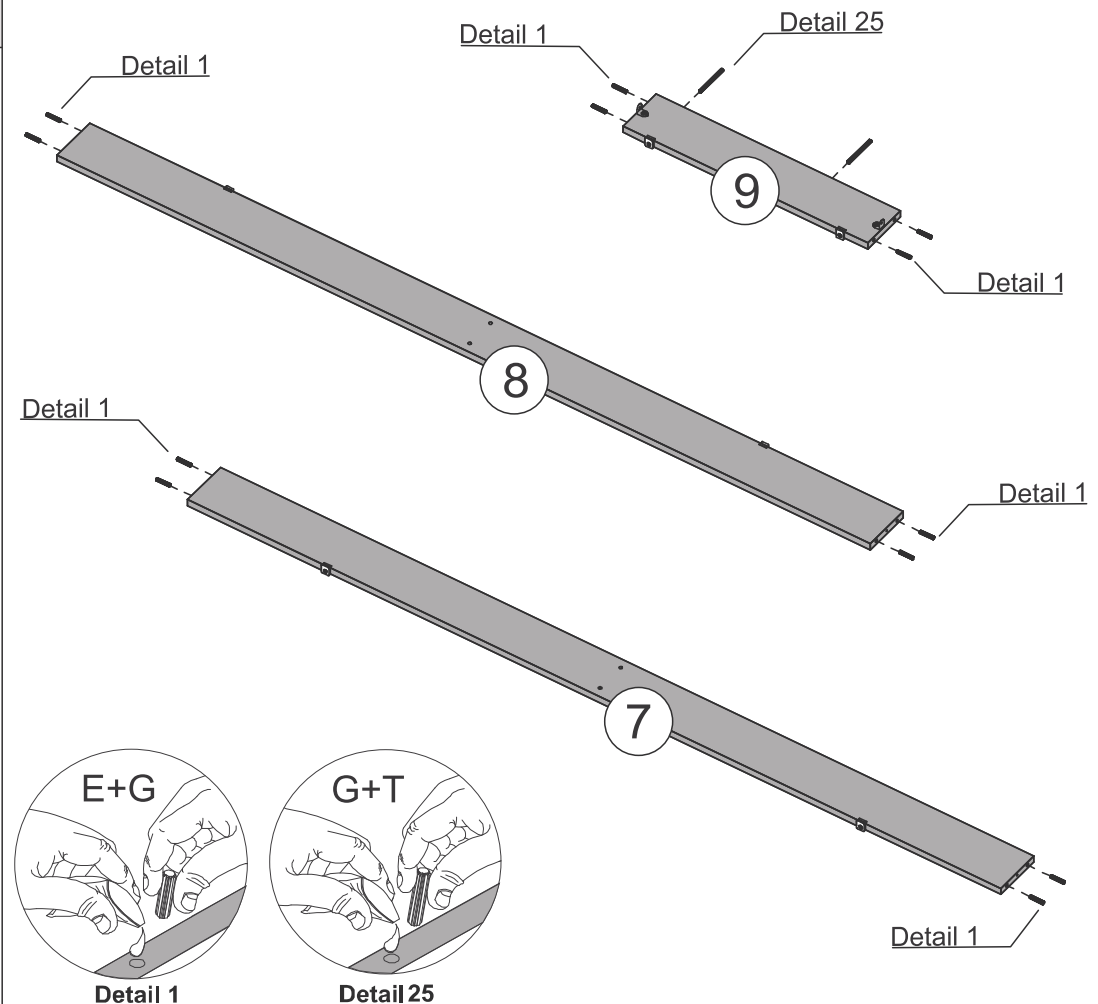
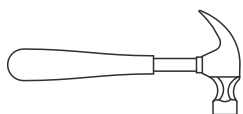



# STEP 3

## PARTS REQUIRED

1 - BASE PANEL x1

## HARDWARE REQUIRED

A  02

E  04

G  01

## TOOLS REQUIRED

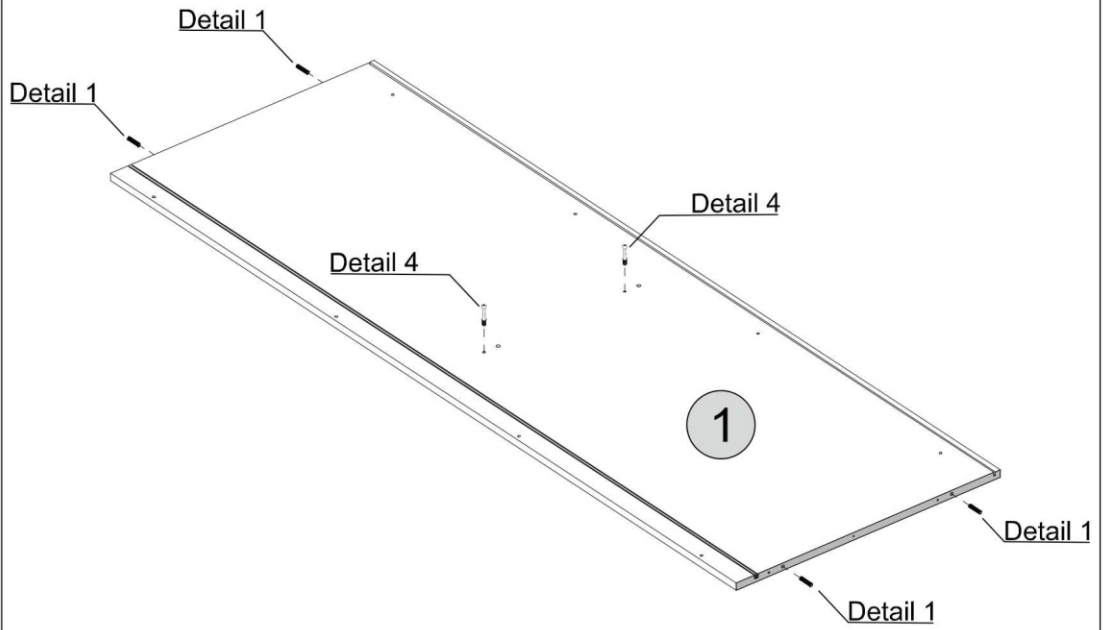
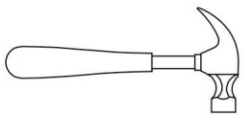
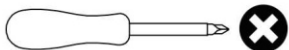

Detail 1

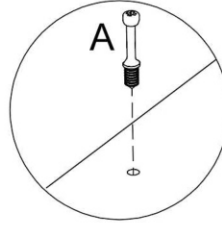

Detail 4

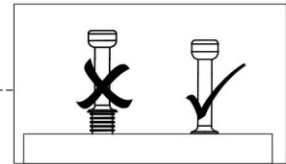

# STEP 4

## PARTS REQUIRED

1 - BASE PANEL x1

## HARDWARE REQUIRED

O  04

V  01

## TOOLS REQUIRED

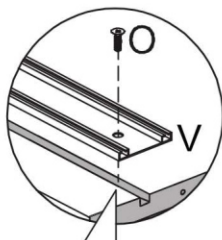
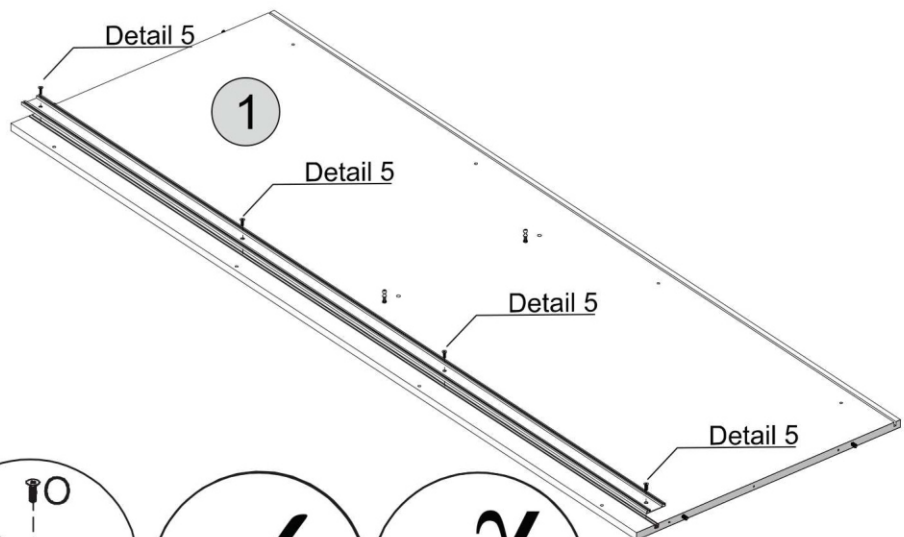
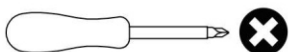

Please use the Groove as a guide for fixing  
**Detail 5**

# STEP 5

## PARTS REQUIRED

6 - SHELF x2

10- FRAME x1

## HARDWARE REQUIRED

C  02

E  08

G  01

J  02

## TOOLS REQUIRED

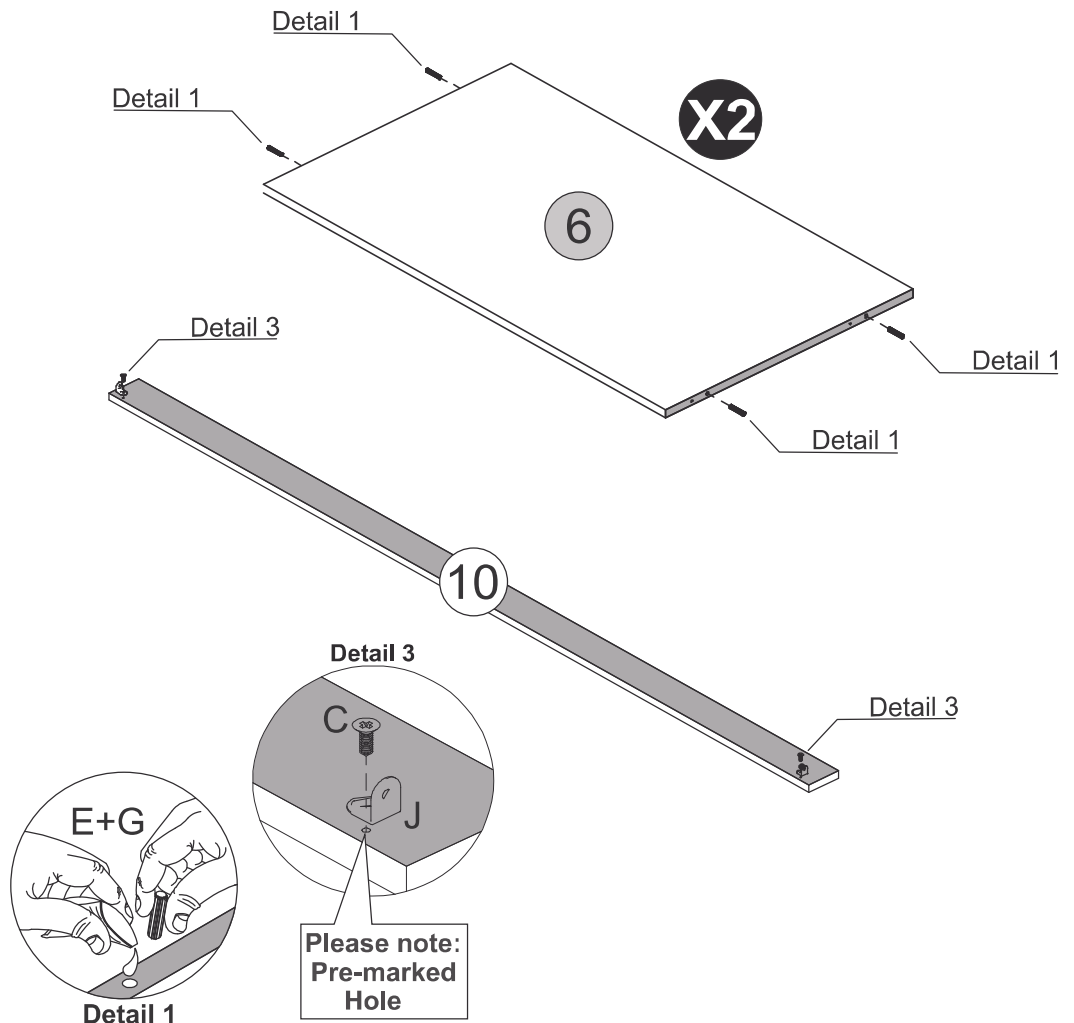
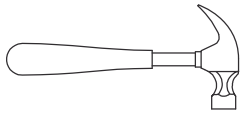
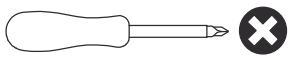

# STEP 6

## PARTS REQUIRED

2 - LEFT SIDE x1

## HARDWARE REQUIRED

C  02

H  02

L  02

M  01

## TOOLS REQUIRED

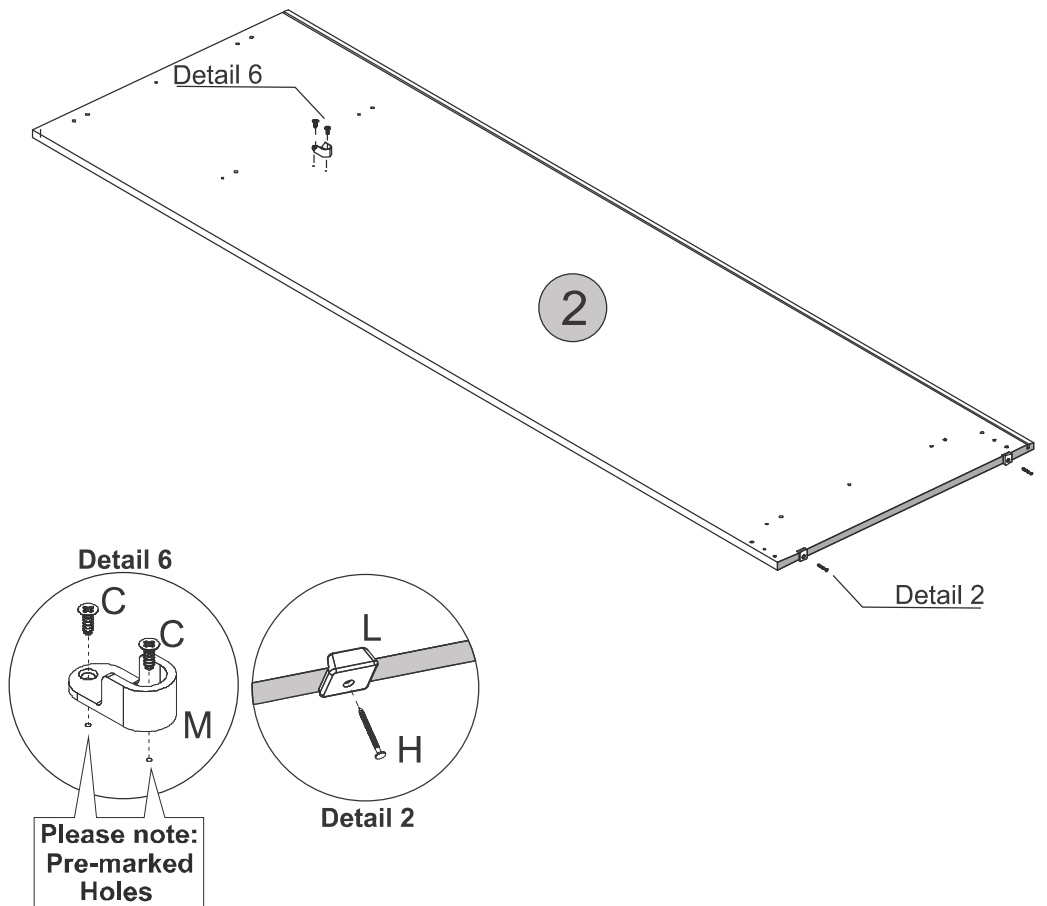
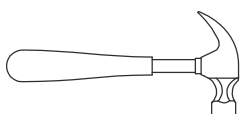
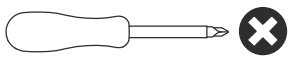

# STEP 7

## PARTS REQUIRED

3 - RIGHT SIDE x1

## HARDWARE REQUIRED

C  02

H  02

L  02

M  01

## TOOLS REQUIRED

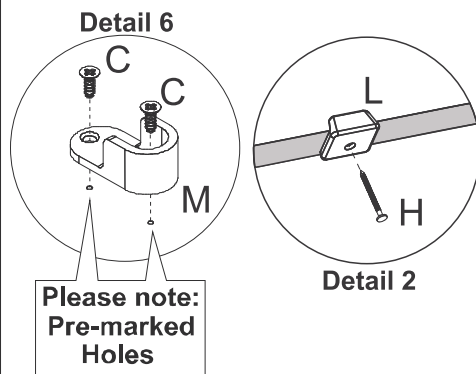
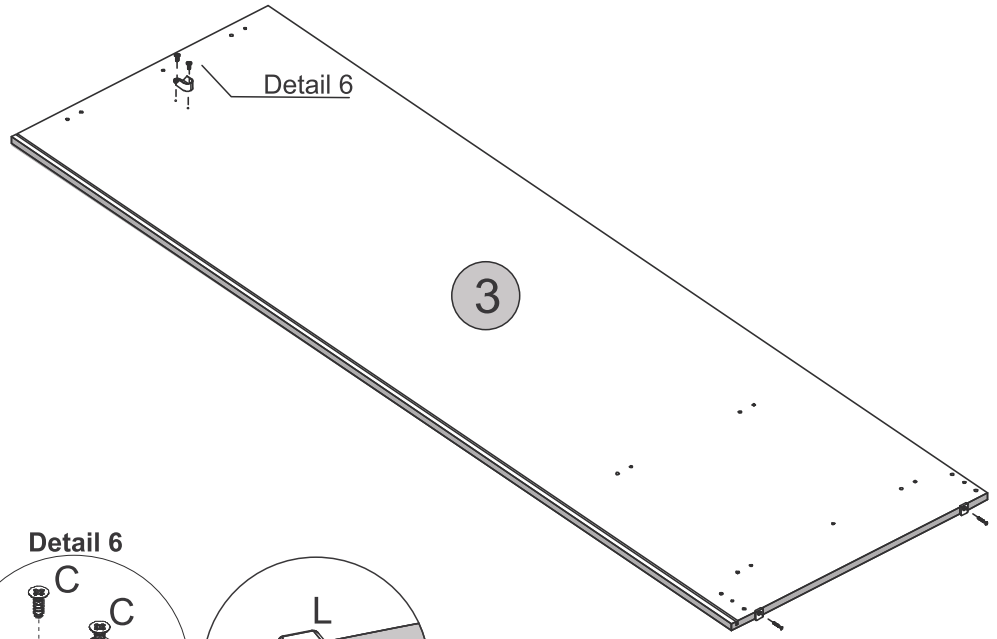
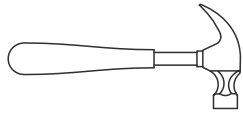
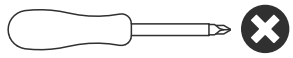

# STEP 8

## PARTS REQUIRED

5 - DIVISION PANEL x1

## HARDWARE REQUIRED

C  02

E  02

G  01

M  01

## TOOLS REQUIRED

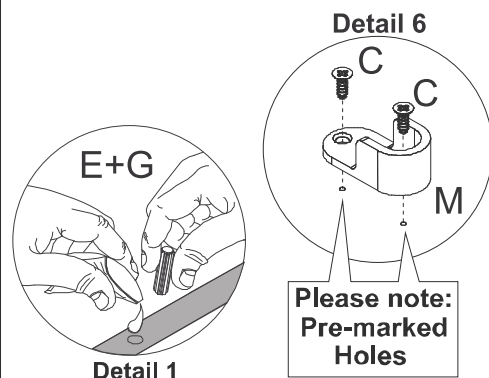
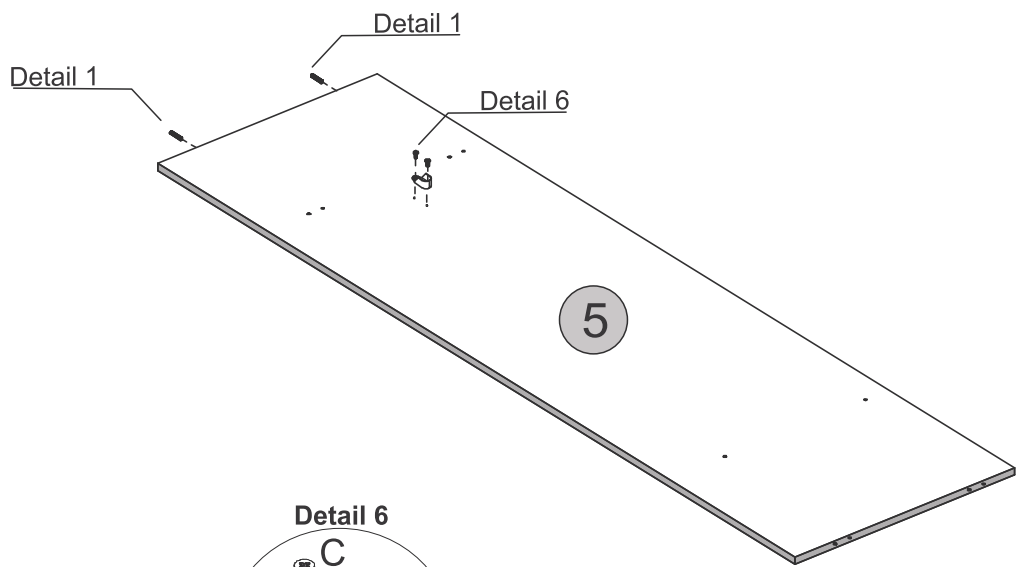
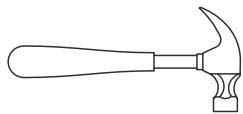
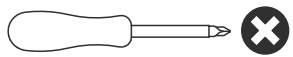

# STEP 9

## PARTS REQUIRED

5 - DIVISION PANEL x1

## HARDWARE REQUIRED

C  02

M  01

## TOOLS REQUIRED

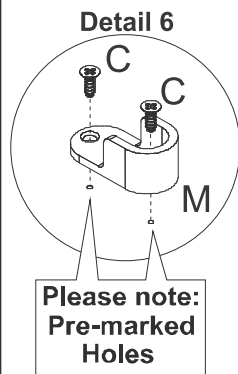
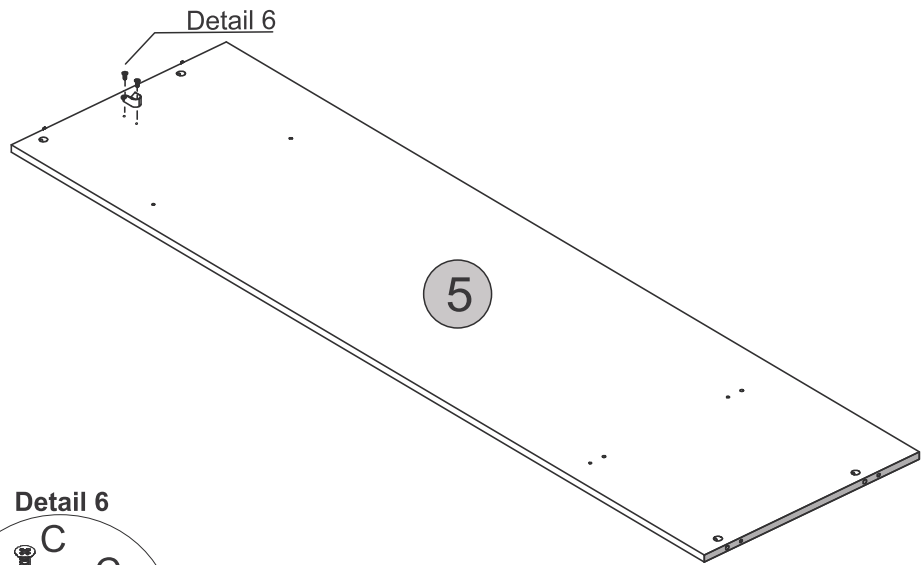
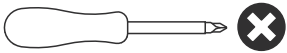

# STEP 10

## PARTS REQUIRED

4 - TOP PANEL x1

## HARDWARE REQUIRED

C  04

E  04

G  01

J  04

## TOOLS REQUIRED

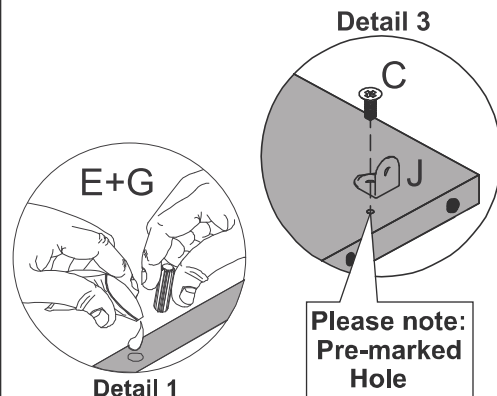
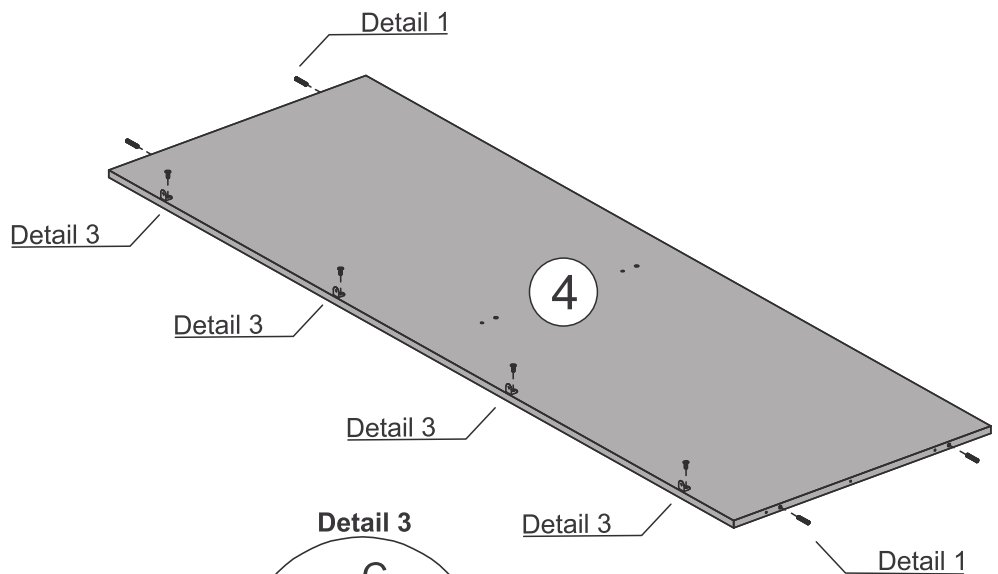
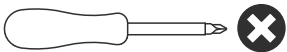



# STEP 11

## PARTS REQUIRED

4 - TOP PANEL x1

## HARDWARE REQUIRED

O  05

X  01

## TOOLS REQUIRED

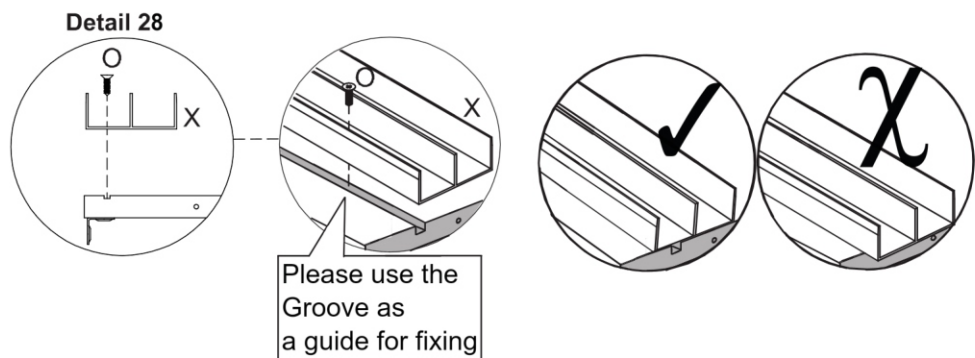
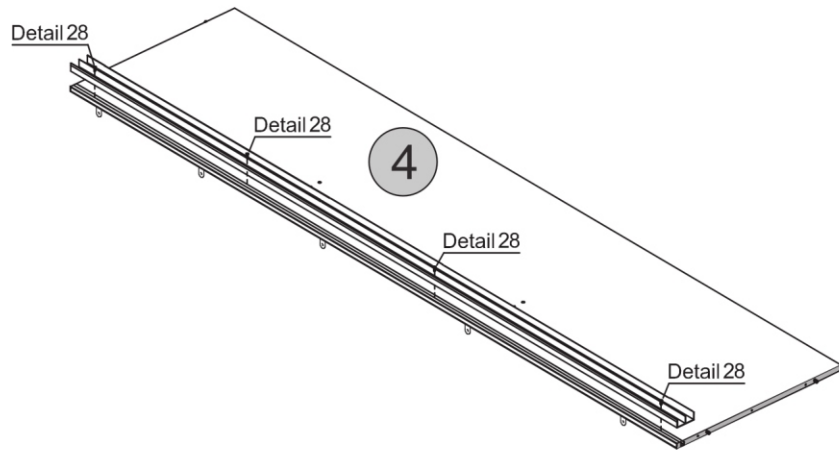



# STEP 12

## PARTS REQUIRED

4 - TOP PANEL x1

## HARDWARE REQUIRED

A  02

O  05

X  01

## TOOLS REQUIRED

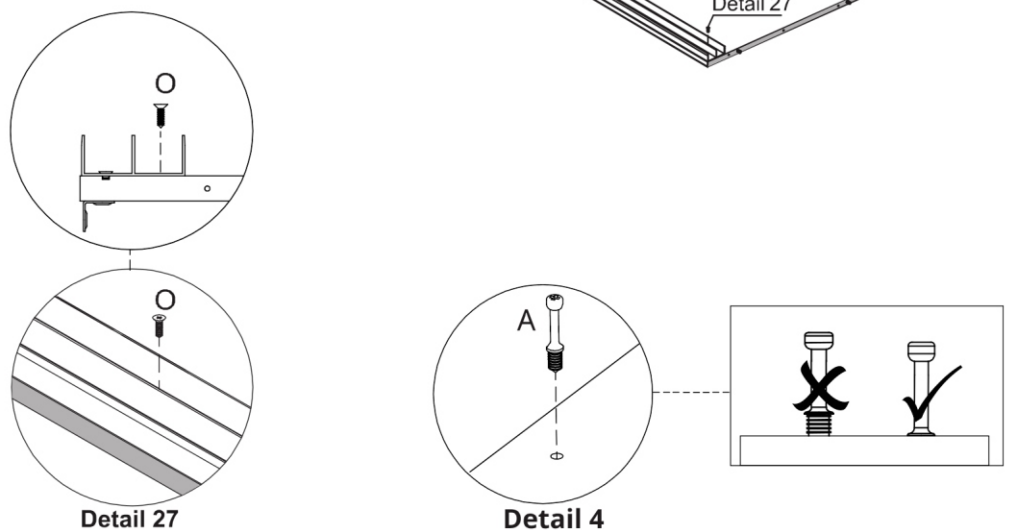
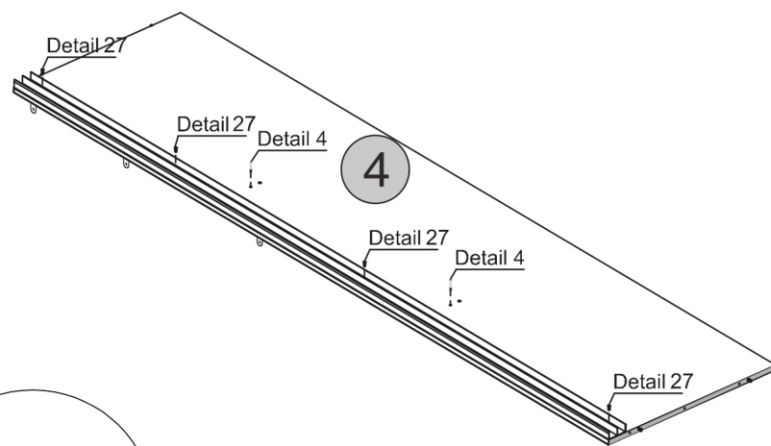



# STEP 13

## PARTS REQUIRED

7 - FRONT BASEBOARD	x1
8 - BACK BASEBOARD	x1
9 - CROSSBEAM	x1

## HARDWARE REQUIRED

C		02
G		01

## TOOLS REQUIRED

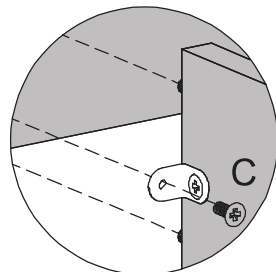
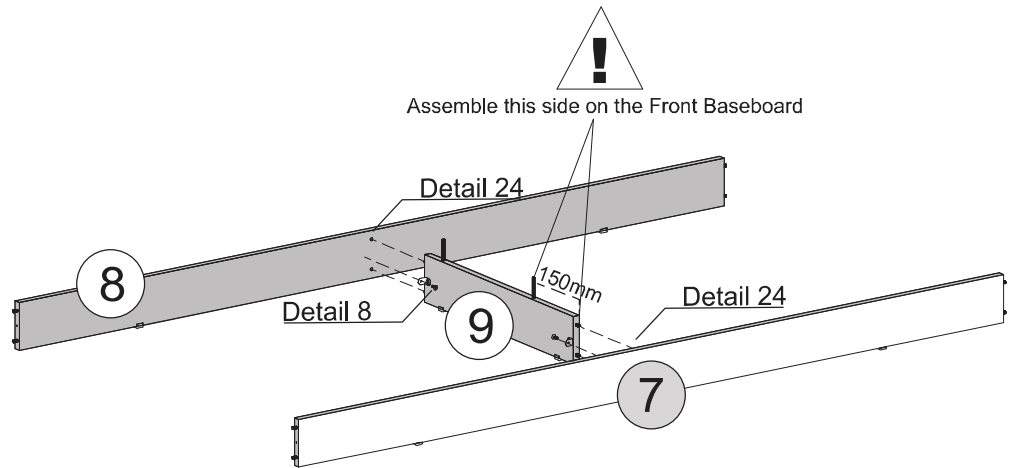
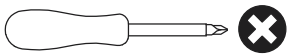

Detail 8

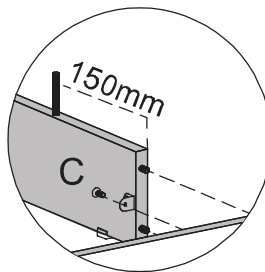

Detail 24



# STEP 14

## PARTS REQUIRED

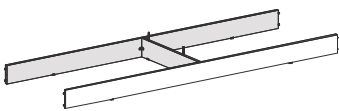
2 - LEFT SIDE	x1
---------------	----



## HARDWARE REQUIRED

F		02
G		01
Q		02

## TOOLS REQUIRED

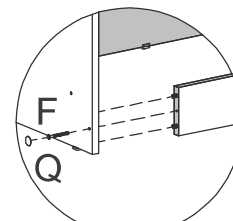
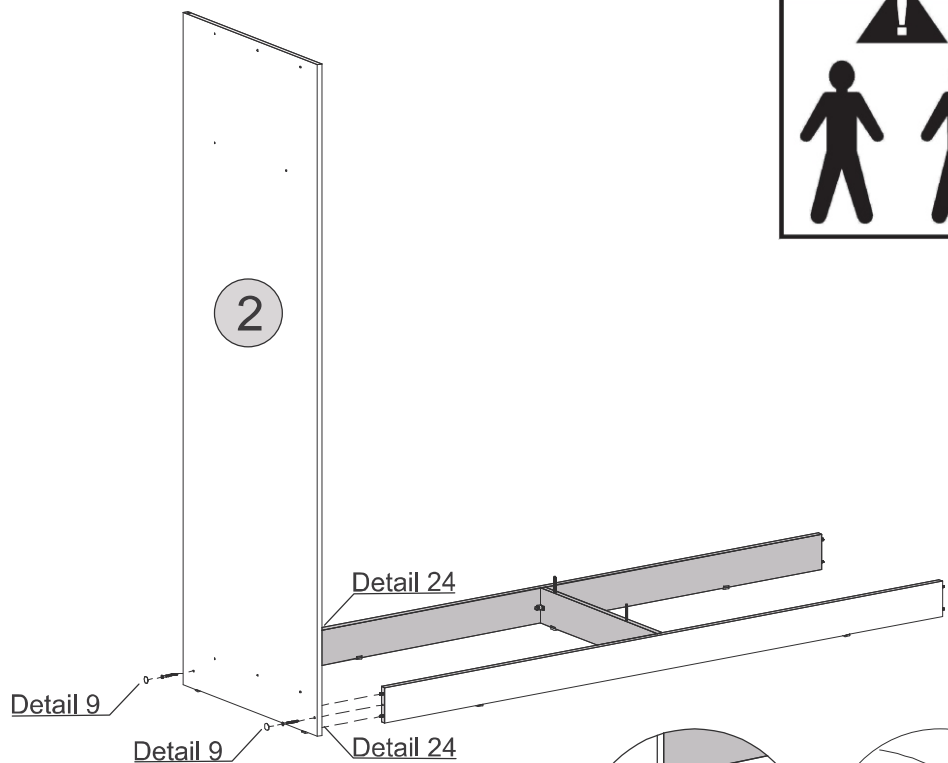
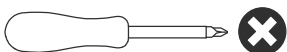

Detail 9

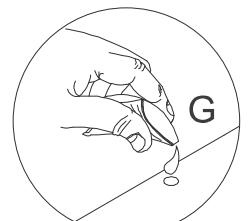

Detail 24

# STEP 15

## PARTS REQUIRED

1 - BASE PANEL x1

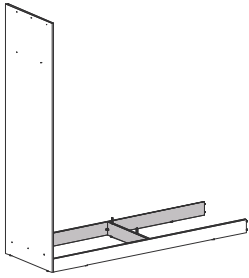

## HARDWARE REQUIRED

F  03

G  01

Q  03

## TOOLS REQUIRED

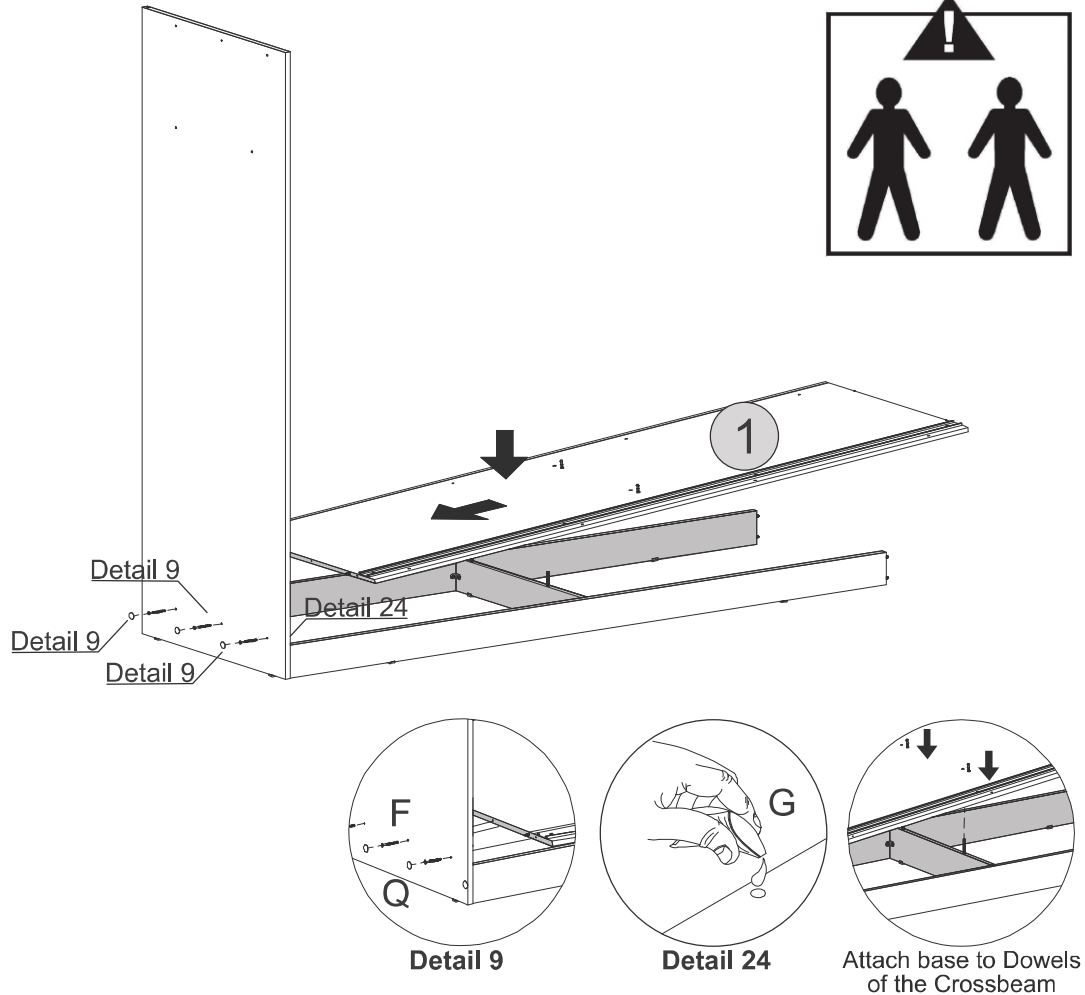
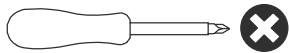

# STEP 16

## PARTS REQUIRED

3 - RIGHT SIDE x1

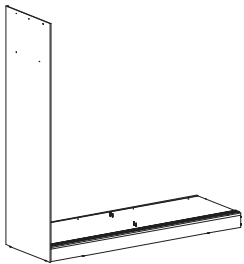

## HARDWARE REQUIRED

F  05

G  01

Q  05

## TOOLS REQUIRED

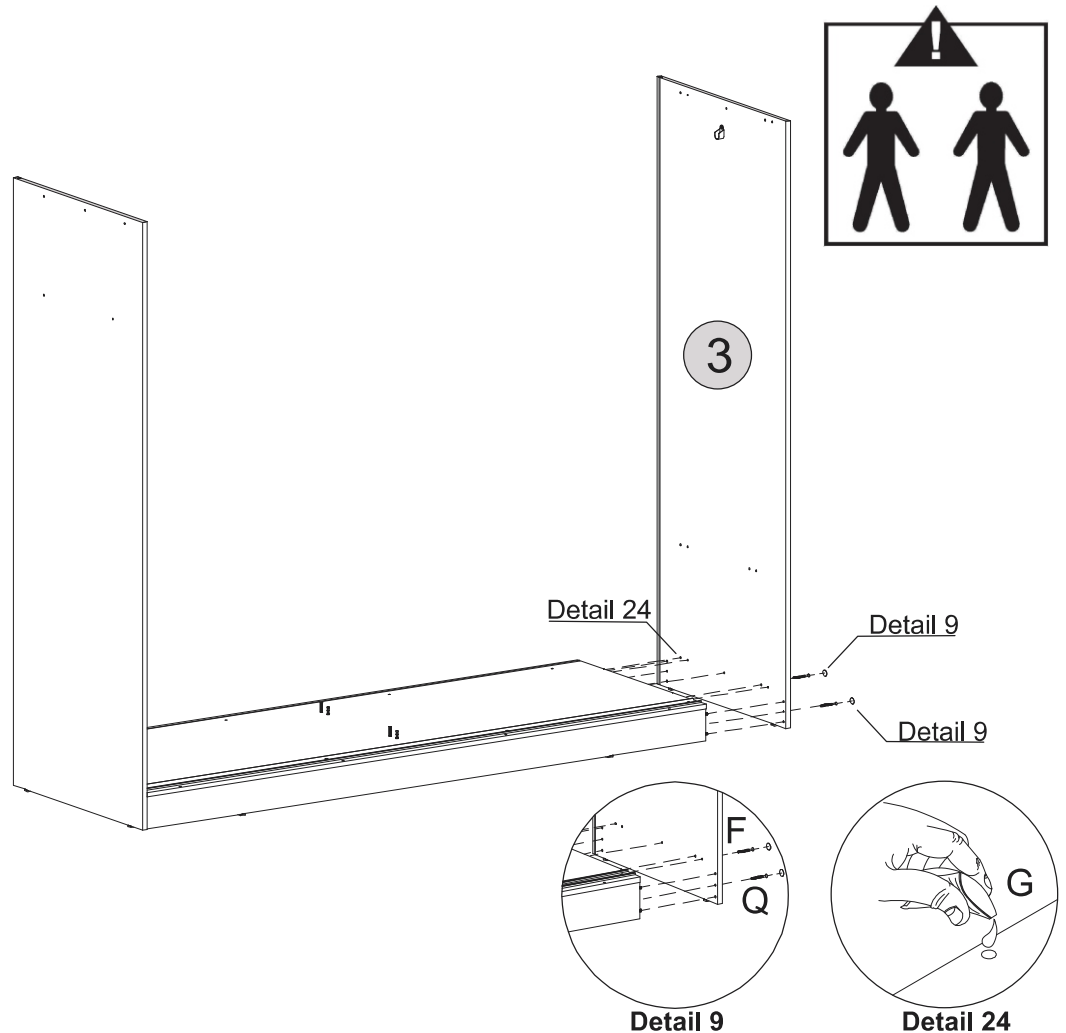
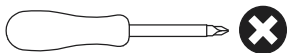



# STEP 17

**PARTS REQUIRED**

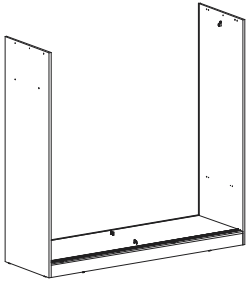

**HARDWARE REQUIRED**

Q		08
R		08

**TOOLS REQUIRED**

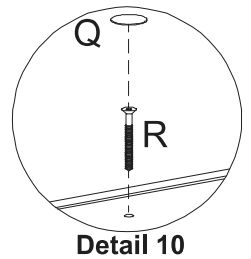
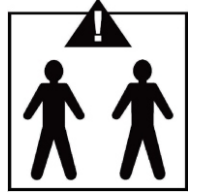
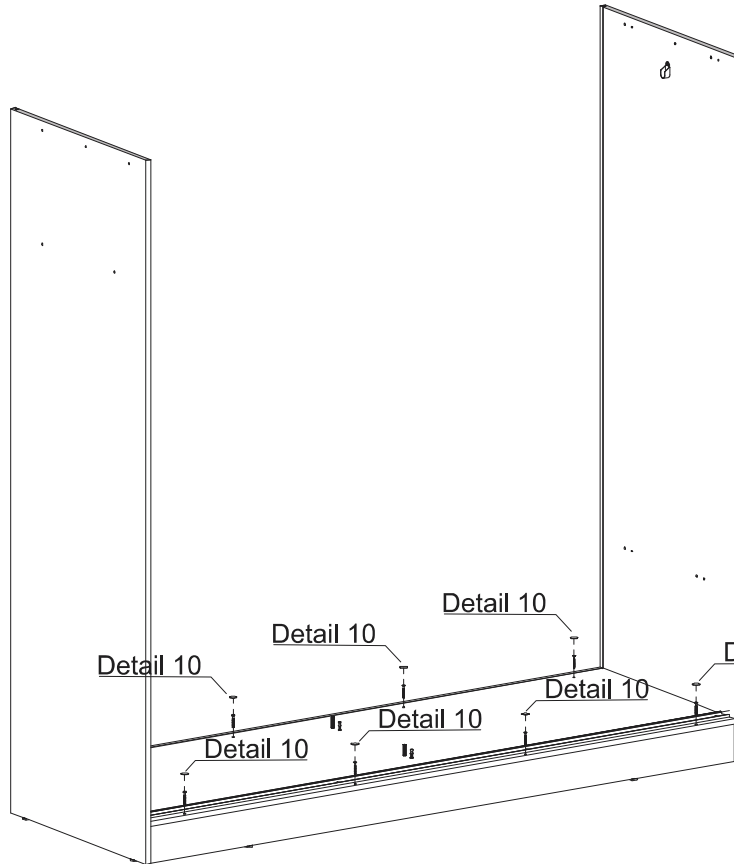
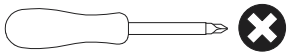

# STEP 18

**PARTS REQUIRED**

5 - DIVISION PANEL	x1
--------------------	----

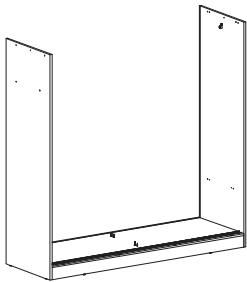

**HARDWARE REQUIRED**

B		02
G		01
Q		02

**TOOLS REQUIRED**

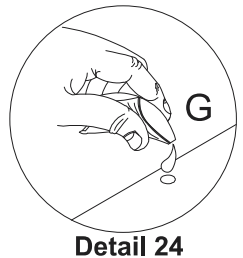
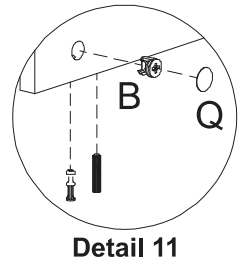
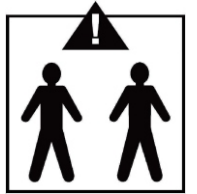
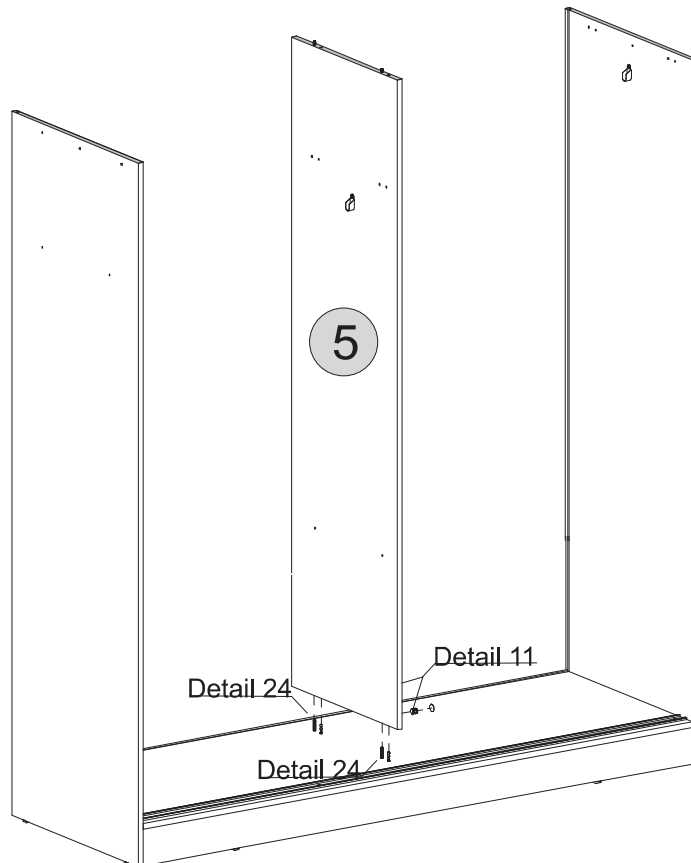
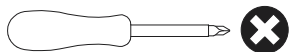



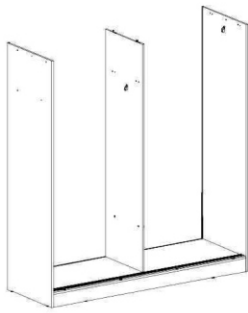

# STEP 19

## PARTS REQUIRED

6 - SHELF x2



## HARDWARE REQUIRED

- F  08
- G  01
- Q  04
- C1  04

## TOOLS REQUIRED

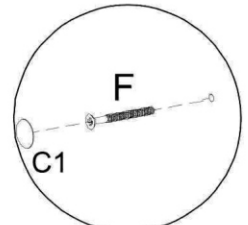
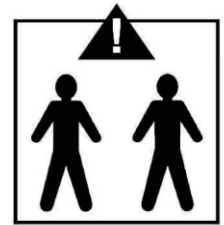
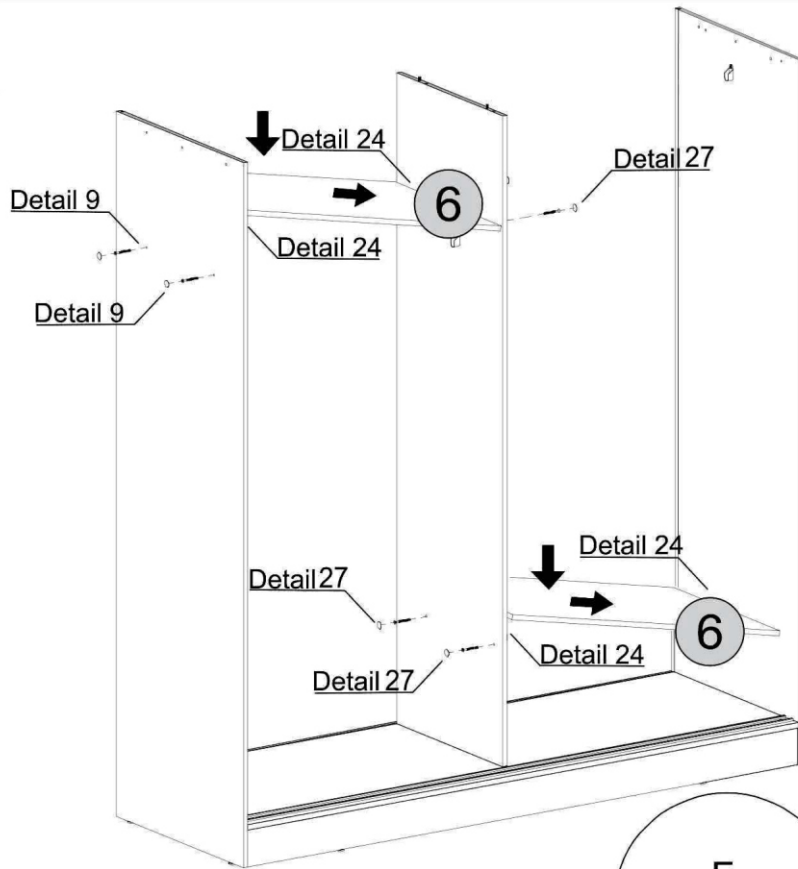
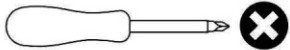

Detail 27

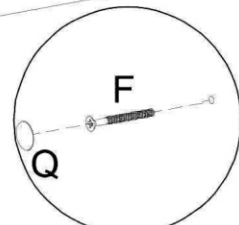

Detail 9

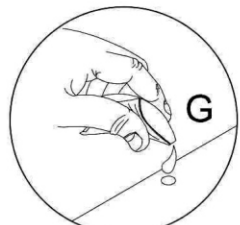

Detail 24





# STEP 20

## PARTS REQUIRED

4 - TOP PANEL x1

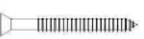

## HARDWARE REQUIRED

- B  02
- F  06
- G  01
- Q  06
- C1  02

## TOOLS REQUIRED

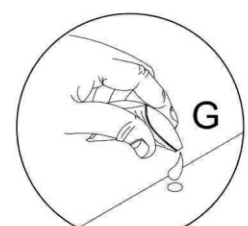
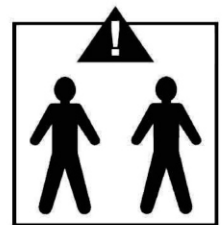
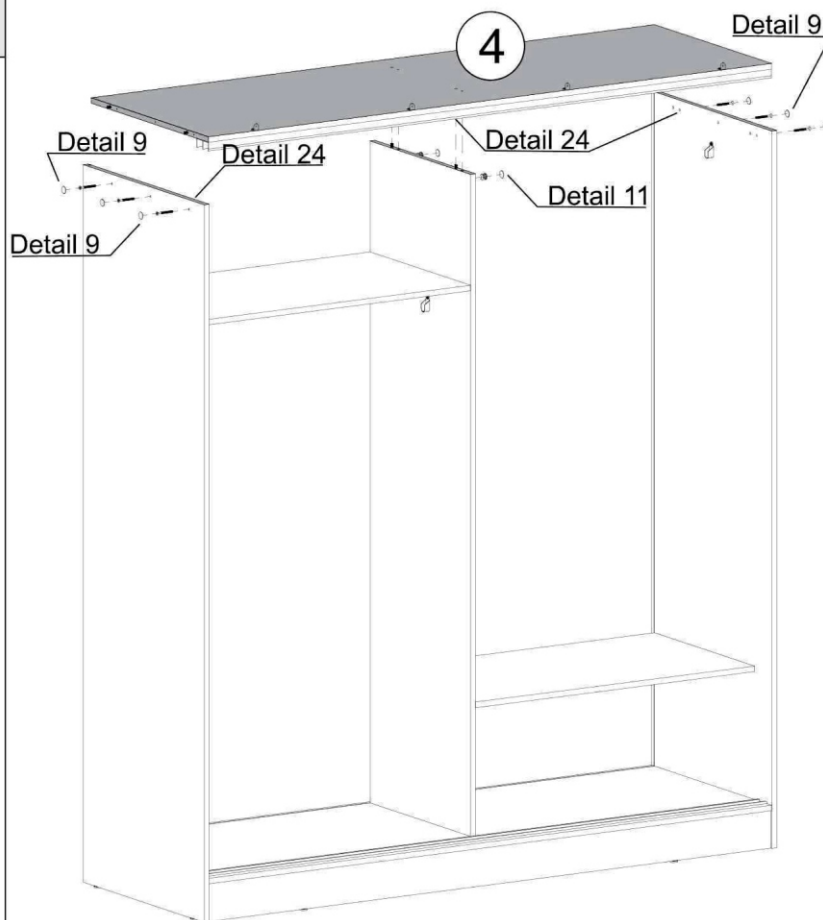
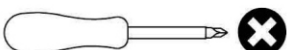

Detail 24

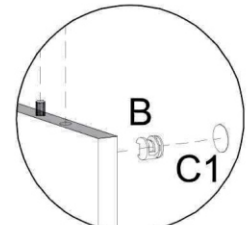

Detail 11

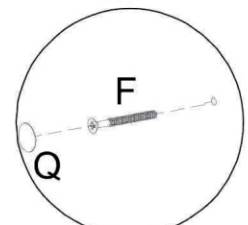

Detail 9

# STEP 21

## PARTS REQUIRED

13 - BACK PANEL x2

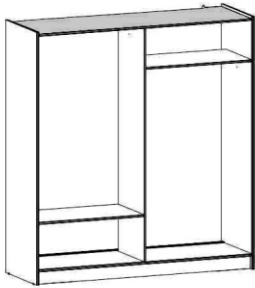

## HARDWARE REQUIRED

H 06

## TOOLS REQUIRED

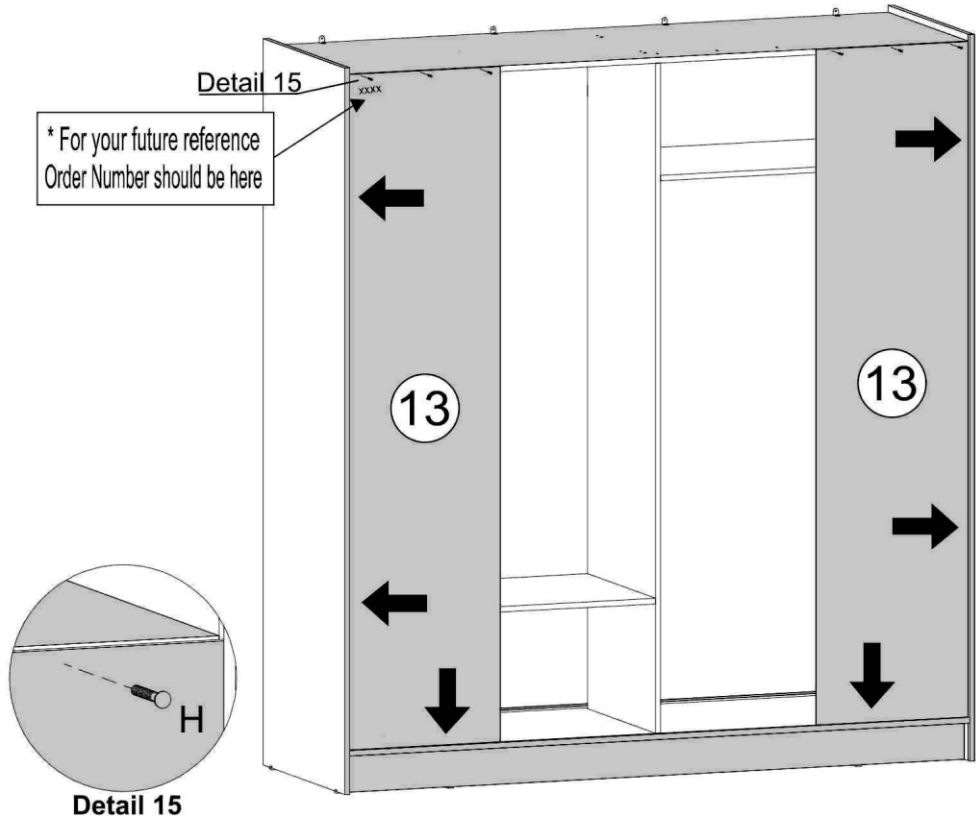
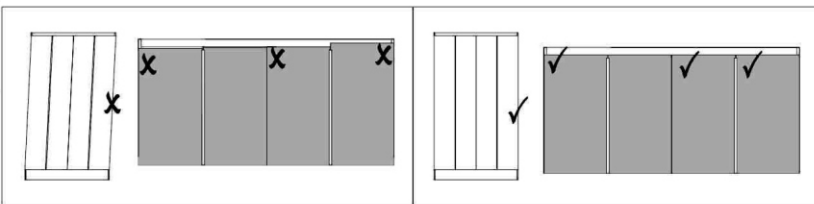
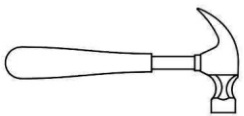

Detail 15

# STEP 22

## PARTS REQUIRED

13 - BACK PANEL x2

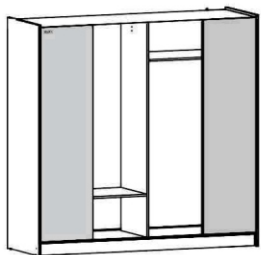

## HARDWARE REQUIRED

H 17

I 11

A1 02

## TOOLS REQUIRED

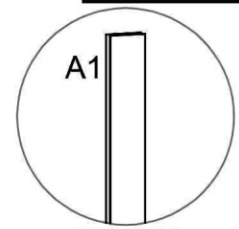
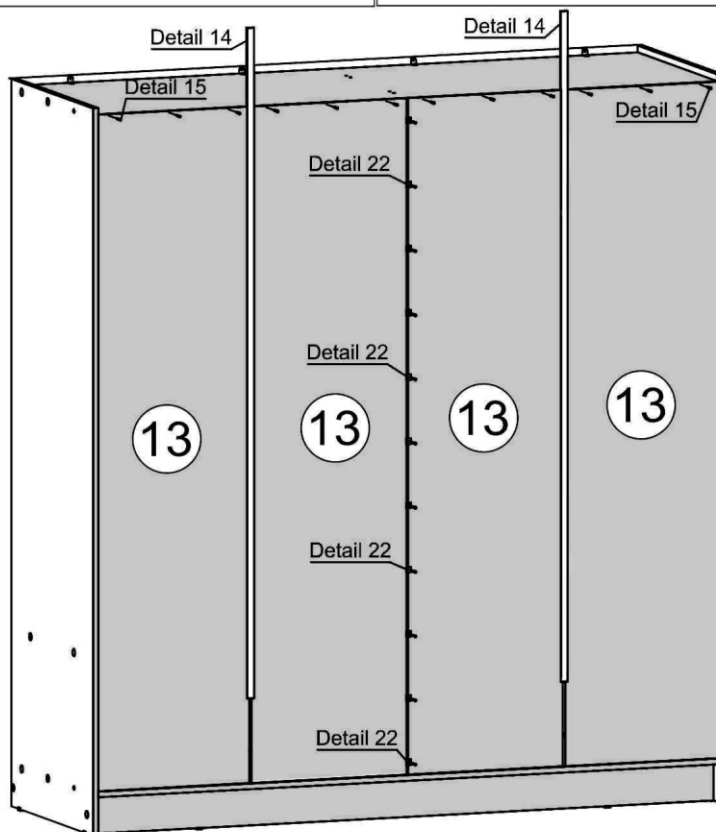
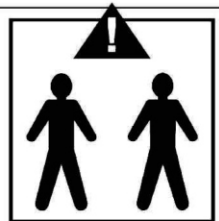
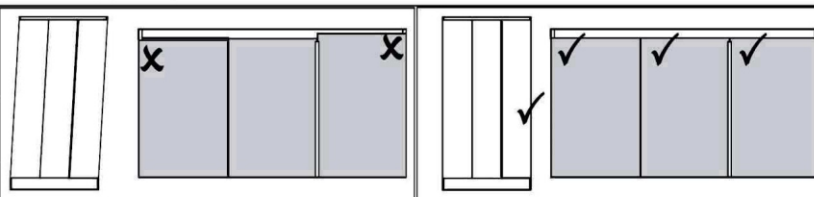
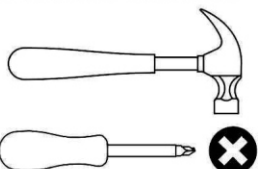

Detail 14

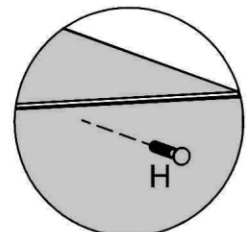

Detail 15

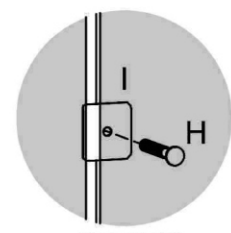

Detail 22

# STEP 23

## PARTS REQUIRED

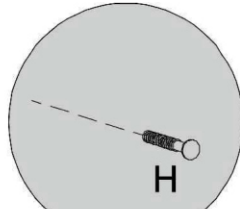
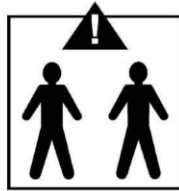
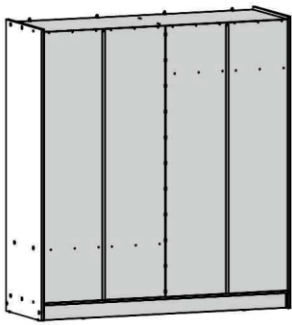

Detail 15

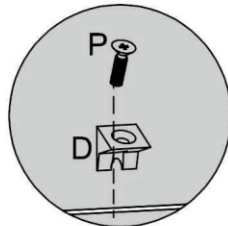

Detail 20

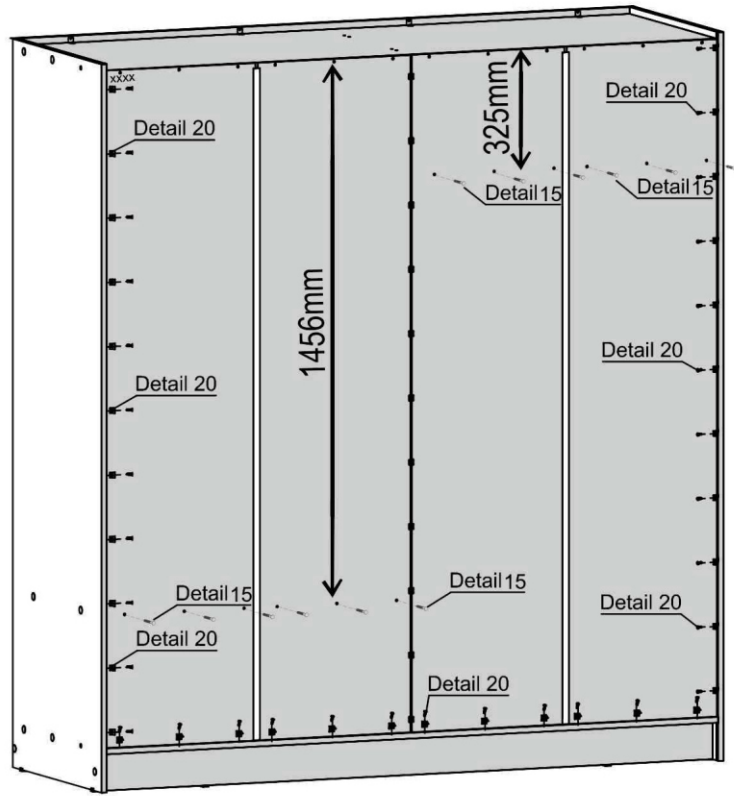

## HARDWARE REQUIRED

D  34

H  12

P  34

## TOOLS REQUIRED

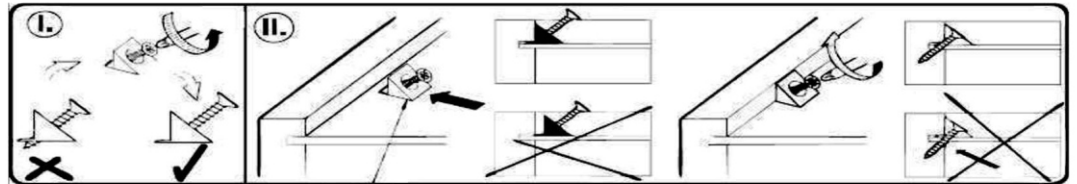
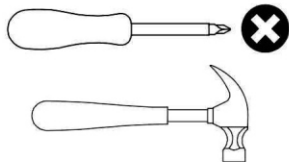

# STEP 24

## PARTS REQUIRED



## HARDWARE REQUIRED

W  02

Y  01

B1  04

B1  04

## TOOLS REQUIRED

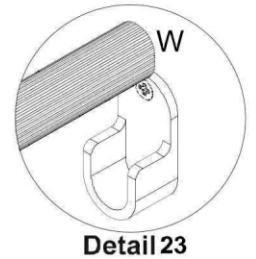
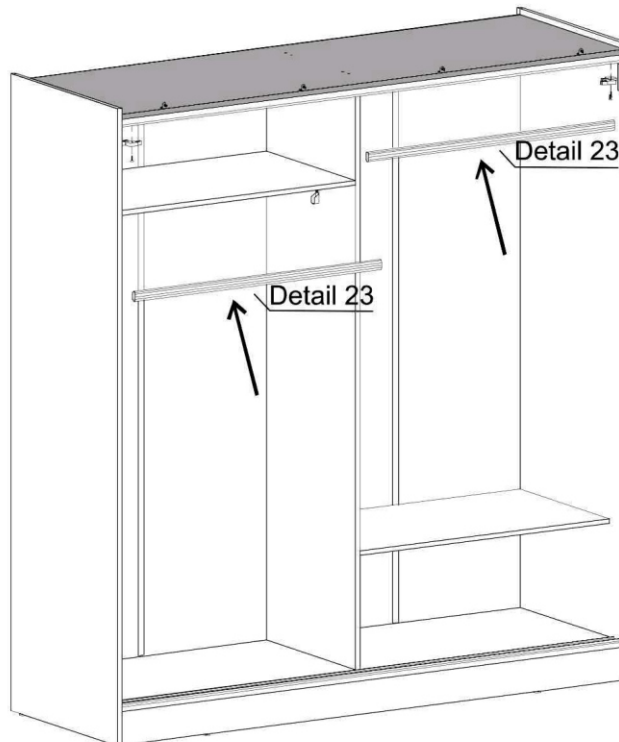
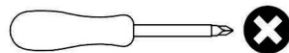

Detail 23

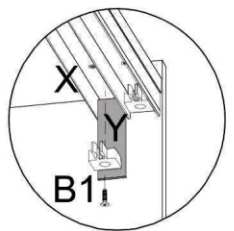
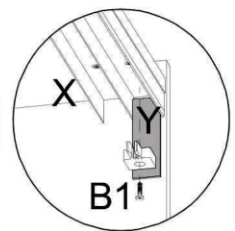
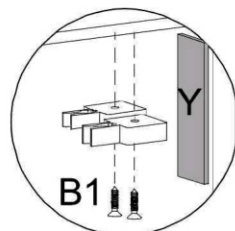
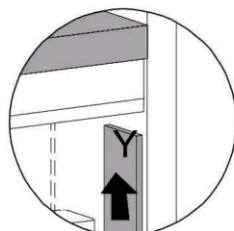

USE TEMPLATE (Y) TO ASSEMBLE THE SLIDING SYSTEM BRAKE

MAKE THIS ASSEMBLY ON BOTH SIDES OF THE WARDROBE

# STEP 25

## PARTS REQUIRED

10 - FRAME x1

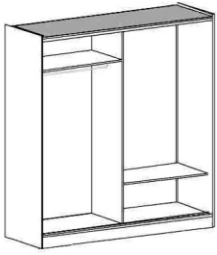

## HARDWARE REQUIRED

C  02

## TOOLS REQUIRED

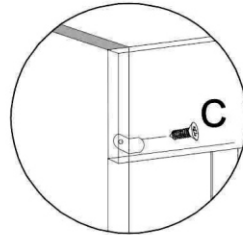
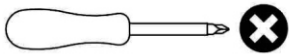

Detail 13

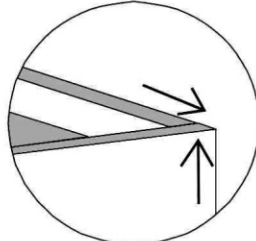

Align Corners

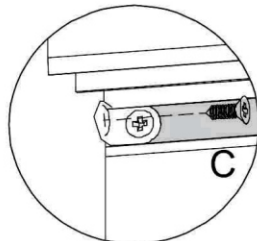

Detail 13

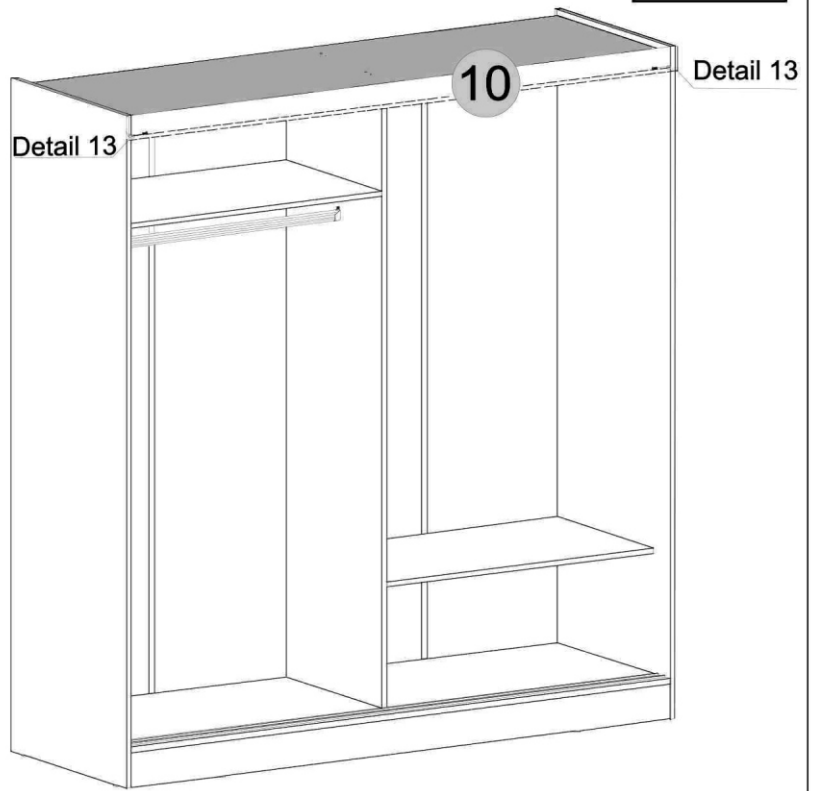

# STEP 26

## PARTS REQUIRED

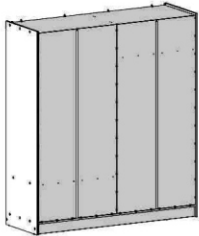

## HARDWARE REQUIRED

C  08

J  02

## TOOLS REQUIRED

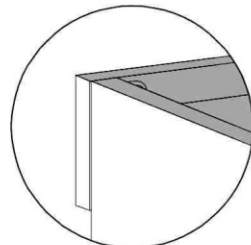
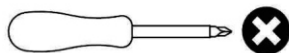

Measure from View to Top

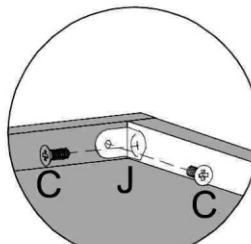
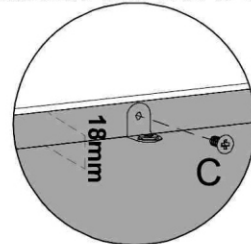

Detail 12

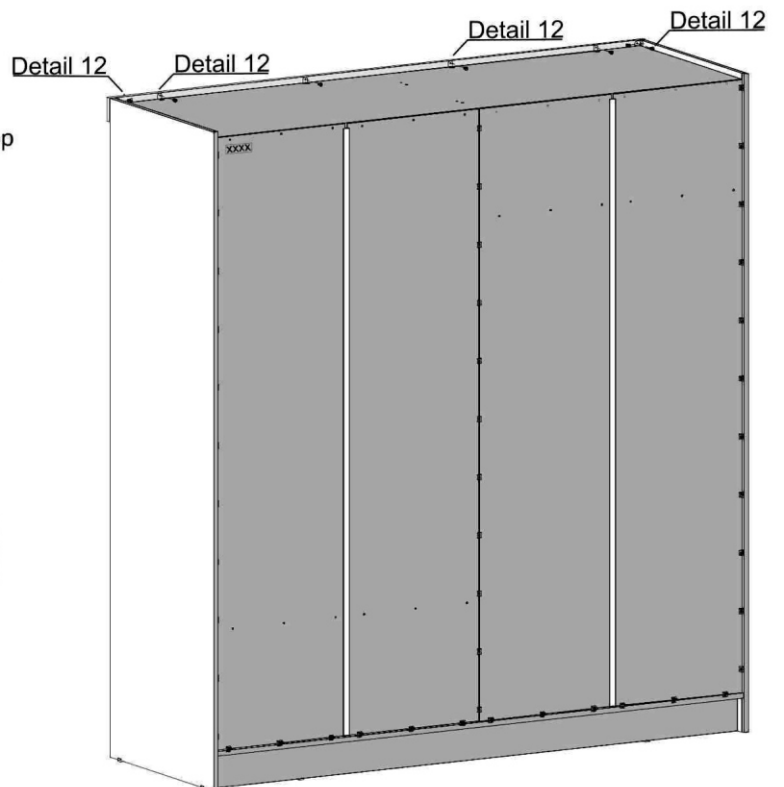



# STEP 27

**PARTS REQUIRED**

11 - MIRRORED DOOR x1

12 - DOOR x1

**HARDWARE REQUIRED**

O  10

Z  02

**TOOLS REQUIRED**

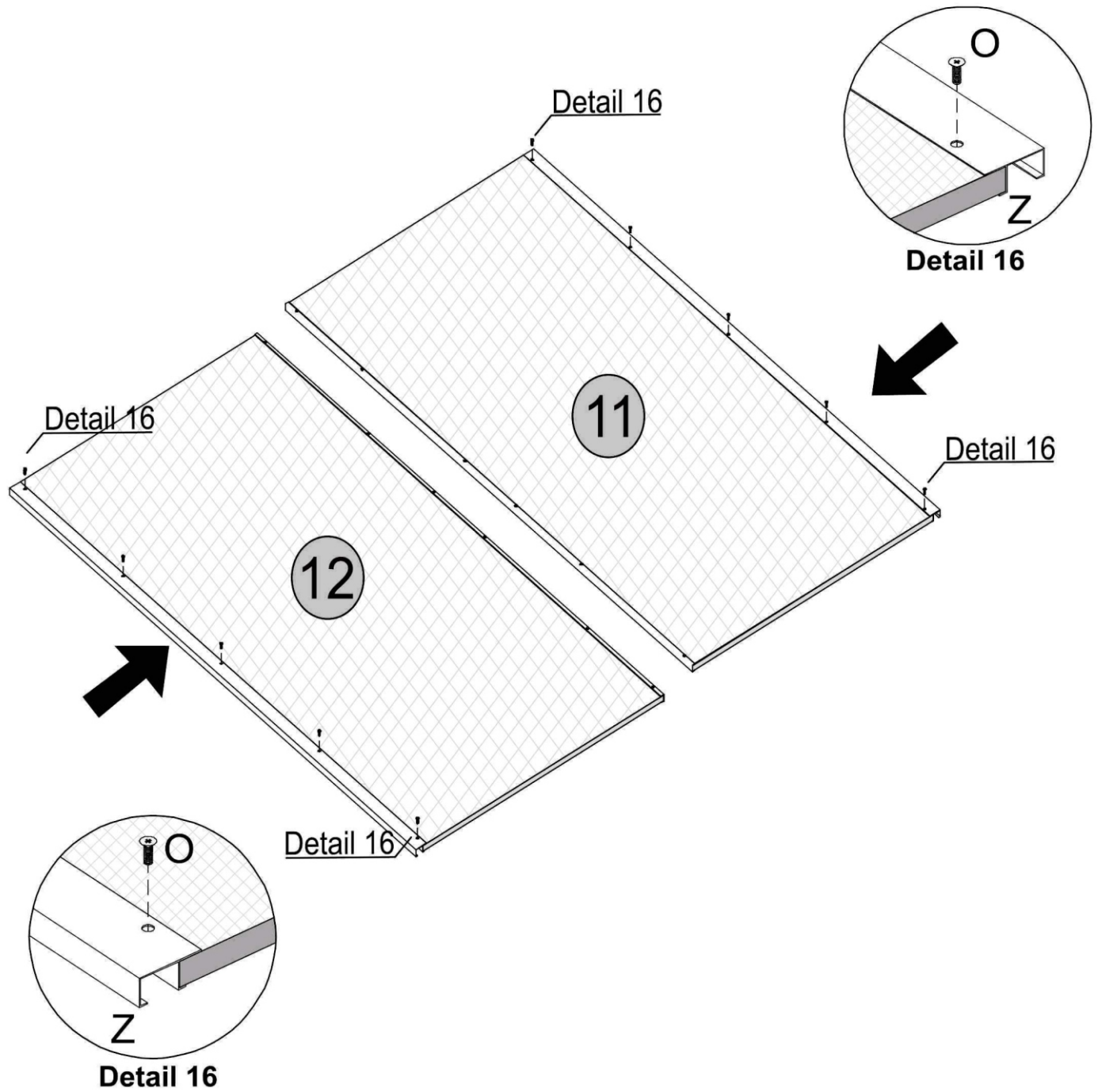
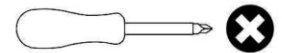

# STEP 28

PARTS REQUIRED

HARDWARE REQUIRED

TOOLS REQUIRED

**B1**

SLIDING SYSTEM KIT

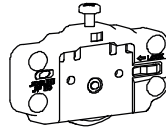
**x2**

Lower Roller Latch x4

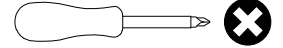
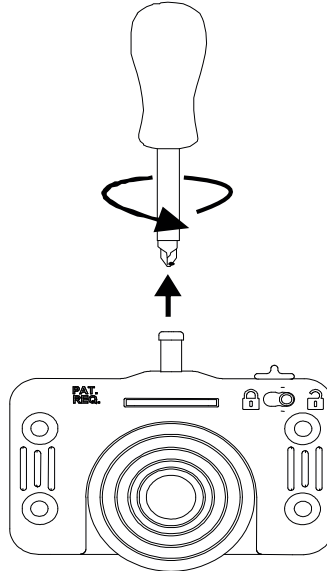
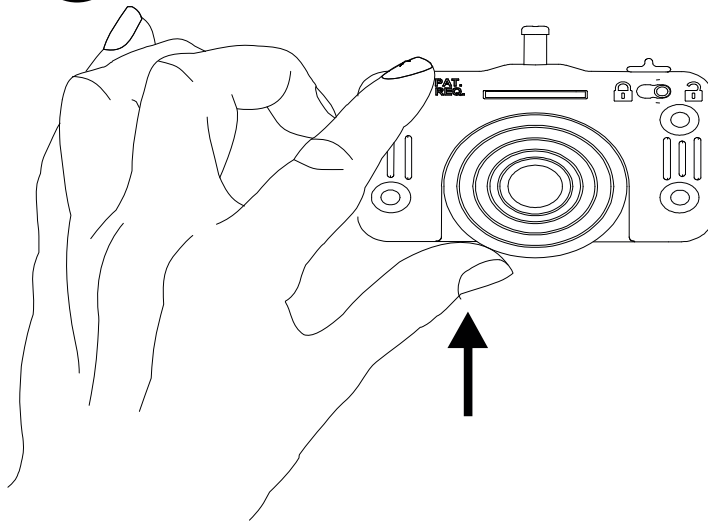
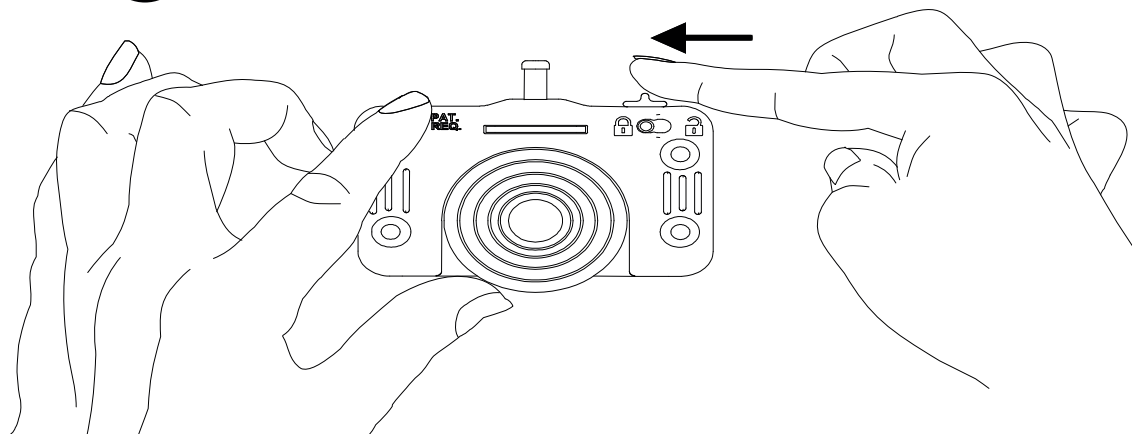
**1°** UNSCREW**2°** PUSH THE WHEEL UP UNTIL IT TOUCHES THE SCREW**3°** SLIDE TO LOCK



# STEP 29

## PARTS REQUIRED

11 - MIRRORED DOOR	x1
12 - DOOR	x1

## HARDWARE REQUIRED

**B1** SLIDING SYSTEM KIT **x2**

Lower Roller Latch x4

Upper Roller Latch x4

Screw Ø3.5 x 16 mm x24

## TOOLS REQUIRED

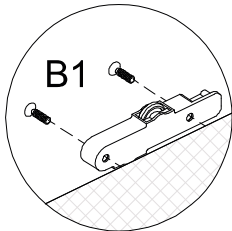
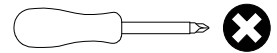

Detail 19

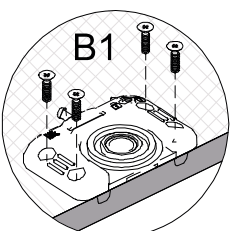
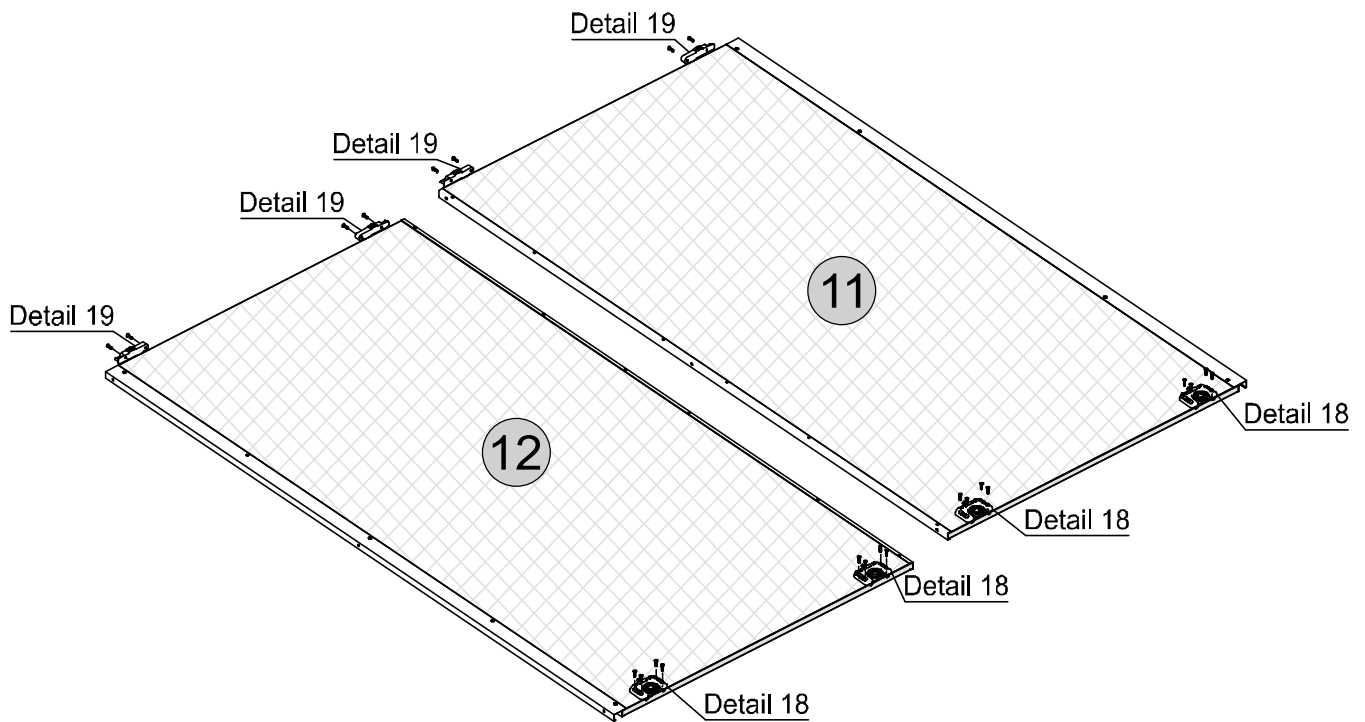
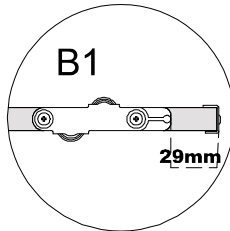
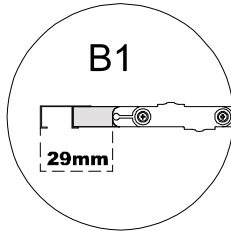

Detail 16

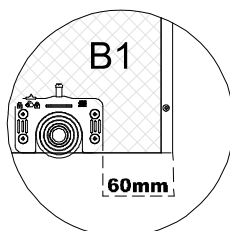
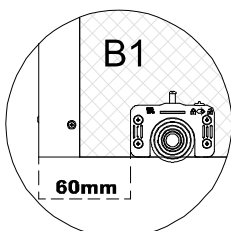

**ATTENTION**

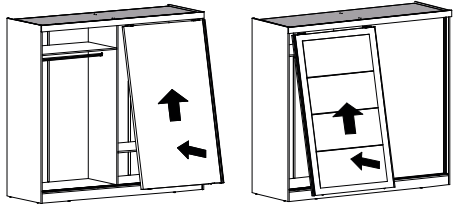

**1°** *Fit the Door*

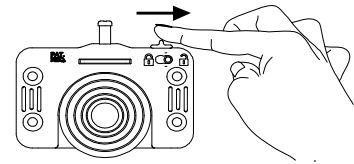

**2°** *Unlock the Pulley*

**STEP 30**

PARTS REQUIRED

12 - DOOR x1

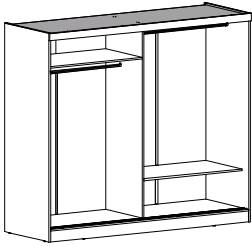

HARDWARE REQUIRED

TOOLS REQUIRED



FIT ON BACK RAIL

FIT ON BACK RAIL

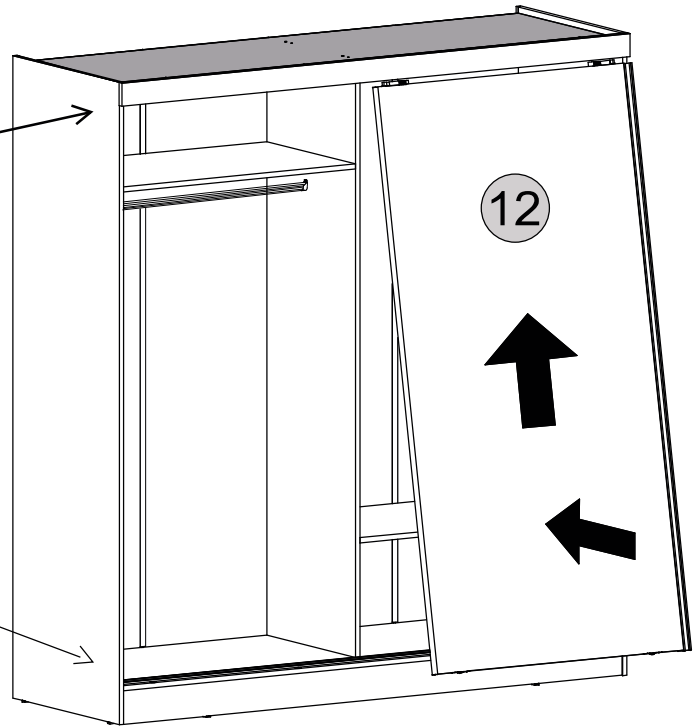

**STEP 31**

PARTS REQUIRED

11 - MIRRORED DOOR x1

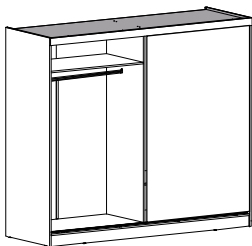

HARDWARE REQUIRED

TOOLS REQUIRED



FIT ON FRONT RAIL

FIT ON FRONT RAIL

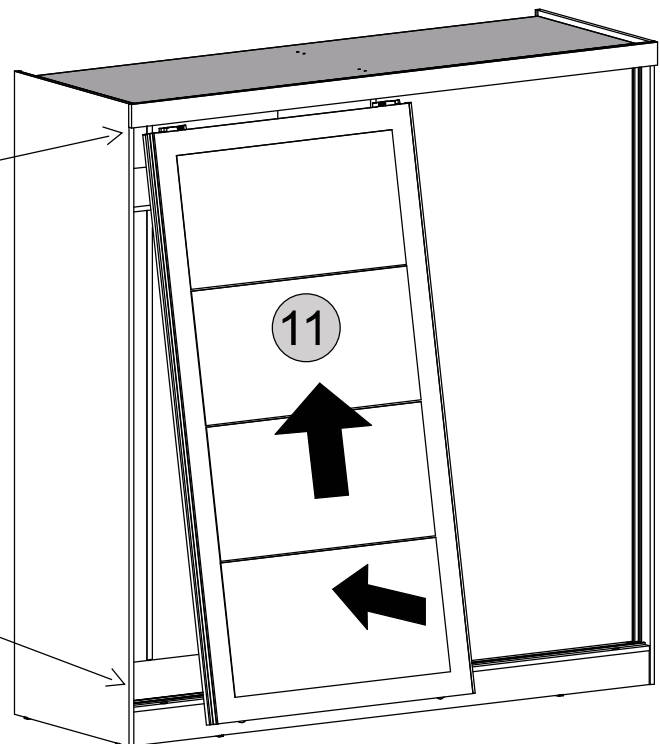

# STEP 32

## PARTS REQUIRED

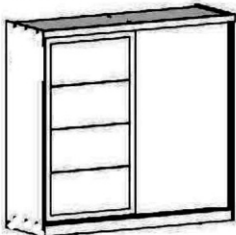

## HARDWARE REQUIRED

U  12

## TOOLS REQUIRED

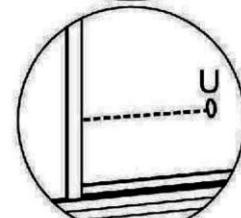
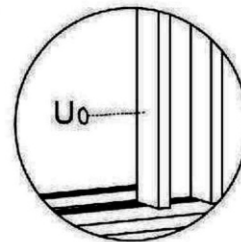
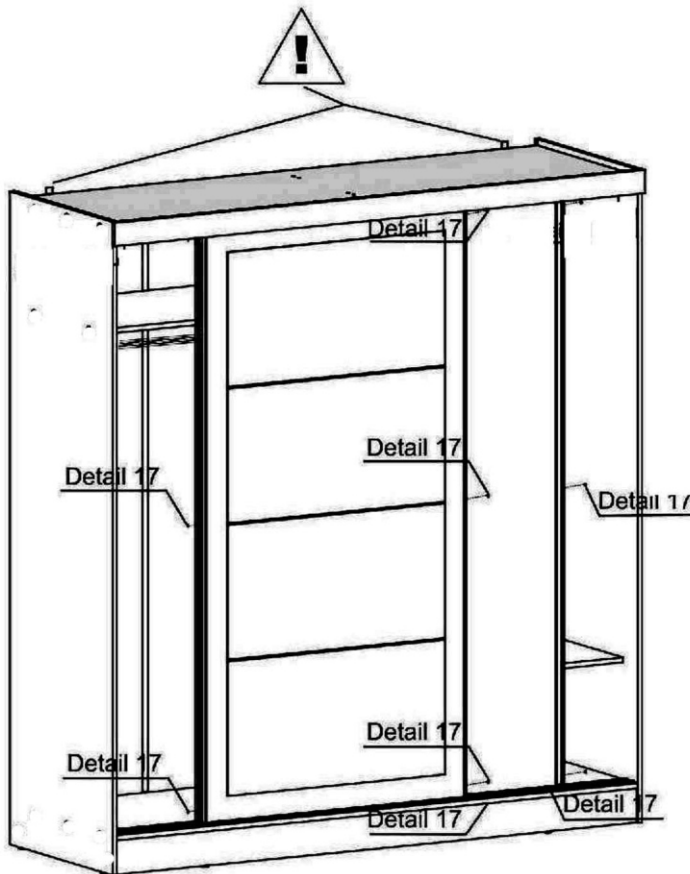

Detail 17

### ATTENTION

*Doors Adjustment*

### Illustrative picture

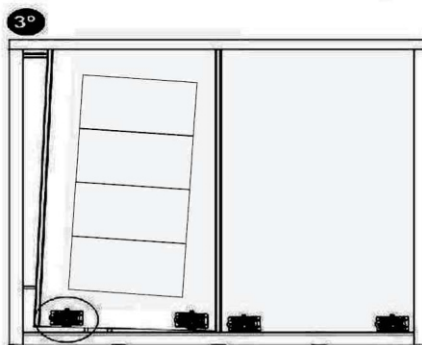
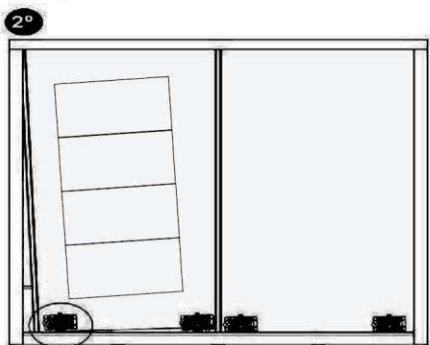
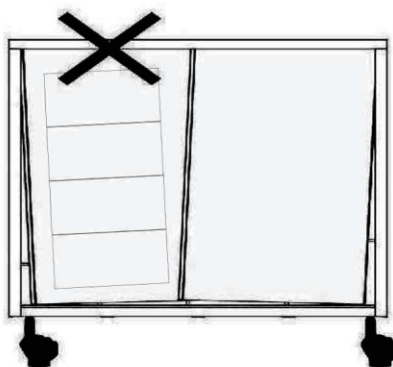
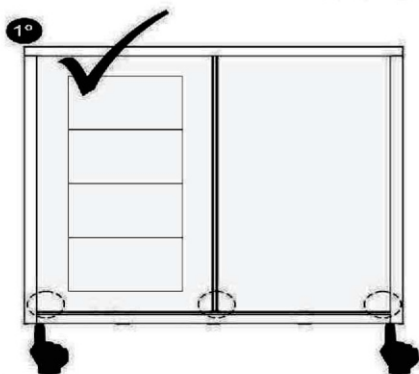

BEFORE REGULATION  
UNLOCK THE PULLEY



BEFORE REGULATION  
UNLOCK THE PULLEY



## WARNING

**Serious or fatal injuries can occur from furniture tipping over. To prevent the furniture from tipping over we recommend that it is permanently fixed to the wall.**

Wall fixings are not supplied with this product as different wall materials require different types of fixing devices.

Please make sure you use fixings suitable for the walls in your home.

