

NEVADA 2 DOOR SLIDER WARDROBE ASSEMBLY INSTRUCTIONS

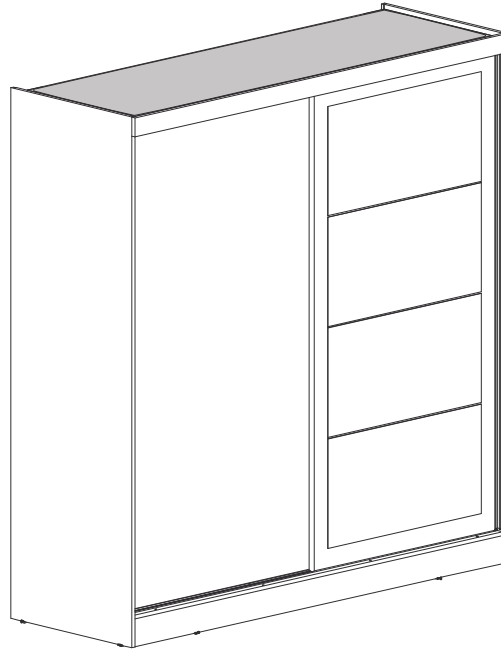
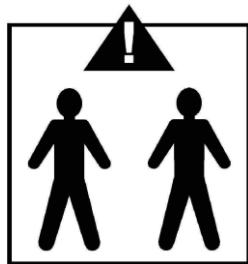

IMPORTANT FOR DOMESTIC USE ONLY

PLEASE READ BEFORE YOU CONTINUE FURTHER

CARE AND MAINTENANCE

After unpacking this product please keep the original packaging in case it needs to be returned for any reason.

- Please ensure all fittings and parts are present before commencing with assembly.
- Never drag or push products as this could cause damage to the joints making it inferior.
- We strongly recommend that you keep children away from your work area.
- We recommend that you lay a blanket or sheet on the floor to avoid damage to both your floor and the product.
- Assemble this product as close to its final position as possible.
- Do not place this product next to a radiator or in direct sunlight.
- Do not drag or push items across your high gloss furniture as this may cause the surface to scratch
- Wood is a natural product and may expand if subjected to damp and may shrink or crack if subjected to heat. Therefore it is recommended that room temperature is maintained, with no sudden temperature fluctuations.
- Make sure any spillage is wiped off immediately.
- Do not place hot or chilled items directly on to the surface, use a place mat or marking will occur.
- For general cleaning use a soft cotton or micro fibre cloth, and do not use detergents of any kind.
- From time to time it may be necessary to tighten fittings, regular inspections should be carried out.
- Do not place on a wet or damp floor as staining may occur to your floor.

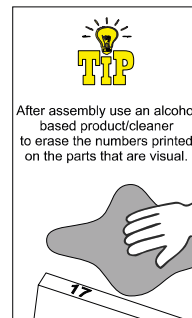
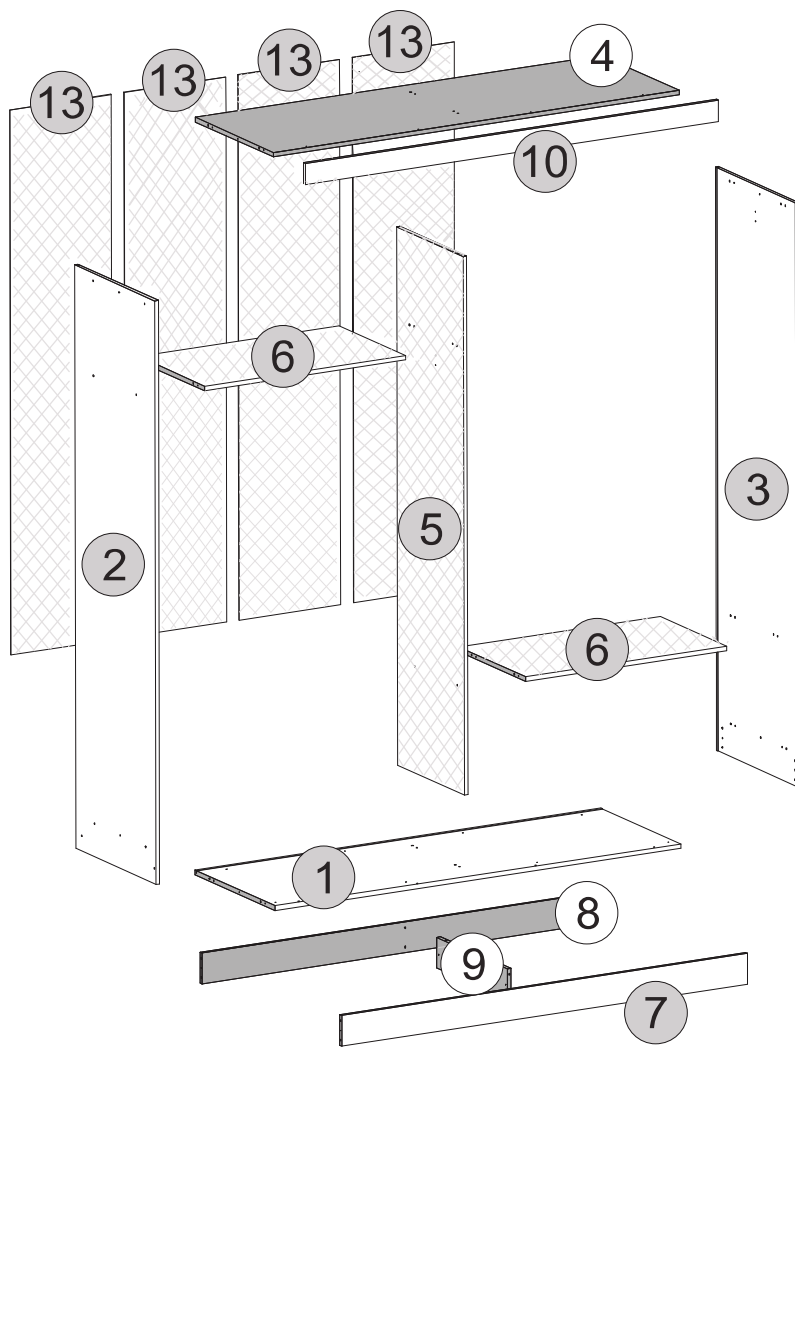



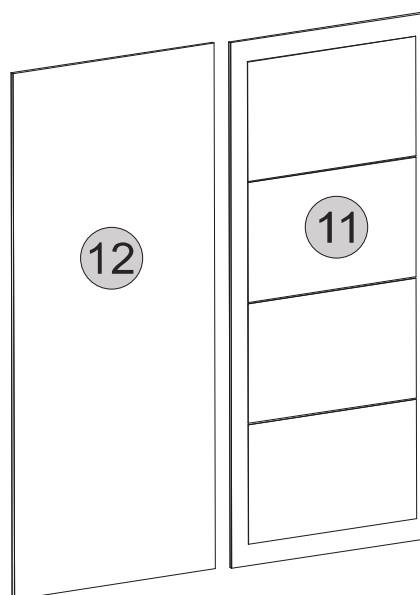
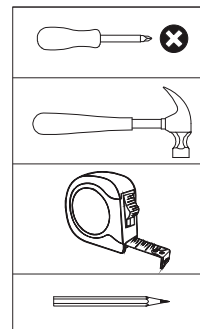







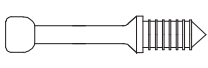

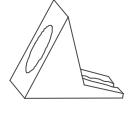



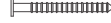
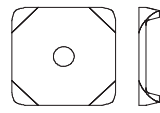
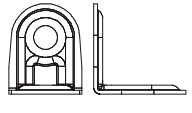

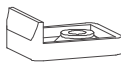



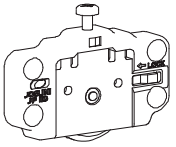

TOOLS REQUIRED

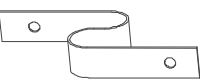

Please Note:
The below parts have all been stamped with the part number to help identify them during assembly.

Part Number	Part Description	Quantity	Carton
1	Base Panel	1	1/3
2	Left Side	1	2/3
3	Right Side	1	2/3
4	Top Panel	1	1/3
5	Division Panel	1	2/3
6	Shelf	2	1/3
7	Front Baseboard	1	1/3
8	Back Baseboard	1	1/3
9	Crossbeam	1	1/3
10	Frame	1	2/3
11	Mirrored Door	1	3/3
12	Door	1	3/3
13	Back Panel	4	2/3

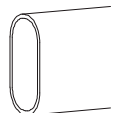
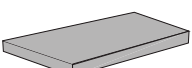
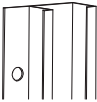
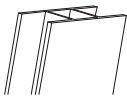

FITTINGS LIST

A x 4  Cam Bolt 32xØ6mm 1/+	B x 4  Can Nut Ø15 mm 1/+	C x 28  Screw Ø4 x 14 mm 2/+	D x 34  Triangle Support Angle 2/+	E x 30  Dowel Ø6 x 30 mm 2/+
F x24  Screw Ø4 x 50 mm 2/+	G x 1  Glue 10g 1/+	H x 45  Nail 10x10 2/+	I x 11  Back Panel Bracket 2/+	J x 10  Metalic Support 18x18 "L" 1/+
K x 4  Washer Ø16x7 mm 1/+	L x 10  Plastic Foot L 19x17x8mm Ø2mm 2/+	M x 4  Support Pipe Oblongo Plastic	N x 2  Screw Ø3,5 x 30 mm 1/+	O x 24  Screw Ø3,5 x 14mm 2/+
P x 34  Screw Ø3 x 16 mm 2/+	Q x28  Hole Plugs 19mm 2/+	R x 8  Screw Ø3.5 x 35 mm 1/+	B1 SLIDING SYSTEM KIT x2   Lower Pulley x4 Sliding System Brake x4  Upper Pulley x4  Screw Ø3.5 x 16 mm x28 (2/+)	
S x 2  Strap 200x20x1mm	T x 2  Dowel Ø6 x 70 mm 1/+	U x 12  Silicone Drop Ø6x2mm	V x 1  Lower Rail 1754x42x5mm Cart. 1/3	W x 2  Hanging Rail 861x27x16 mm Cart. 1/3
Y x1  Gabarito MDF 80x29x3mm	Z x 2  Handle Profile 1760x38x16mm Cart. 2/3	A1 x 2  Back Panel Strip H 1787x19x7mm Cart. 2/3	C1 x 8  Hole Plugs Lineo 19mm 2/+	

TIPS FOR FITTINGS CAM-LOCKS

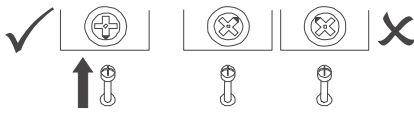
WHEN FITTING CAM NUT, ENSURE STARTING POSITION IS CORRECT BEFORE YOU INSERT CONNECTING CAM BOLT TURN CLOCKWISE UNTIL SECURE



 CORRECT  WRONG

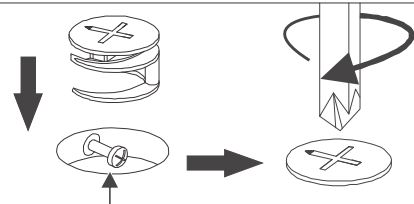

Cam bolt head needs to be in centre

CAMBOLT

Tighten until shoulder in flush with panel. Do not overtighten or undertighten (see example beside)

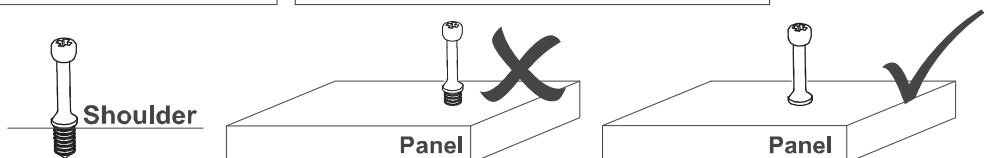





STEP 1

PARTS REQUIRED

7 - FRONT BASEBOARD	x1
8 - BACK BASEBOARD	x1
9 - CROSSBEAM	x1

HARDWARE REQUIRED

C		02
H		06
J		02
L		06

TOOLS REQUIRED

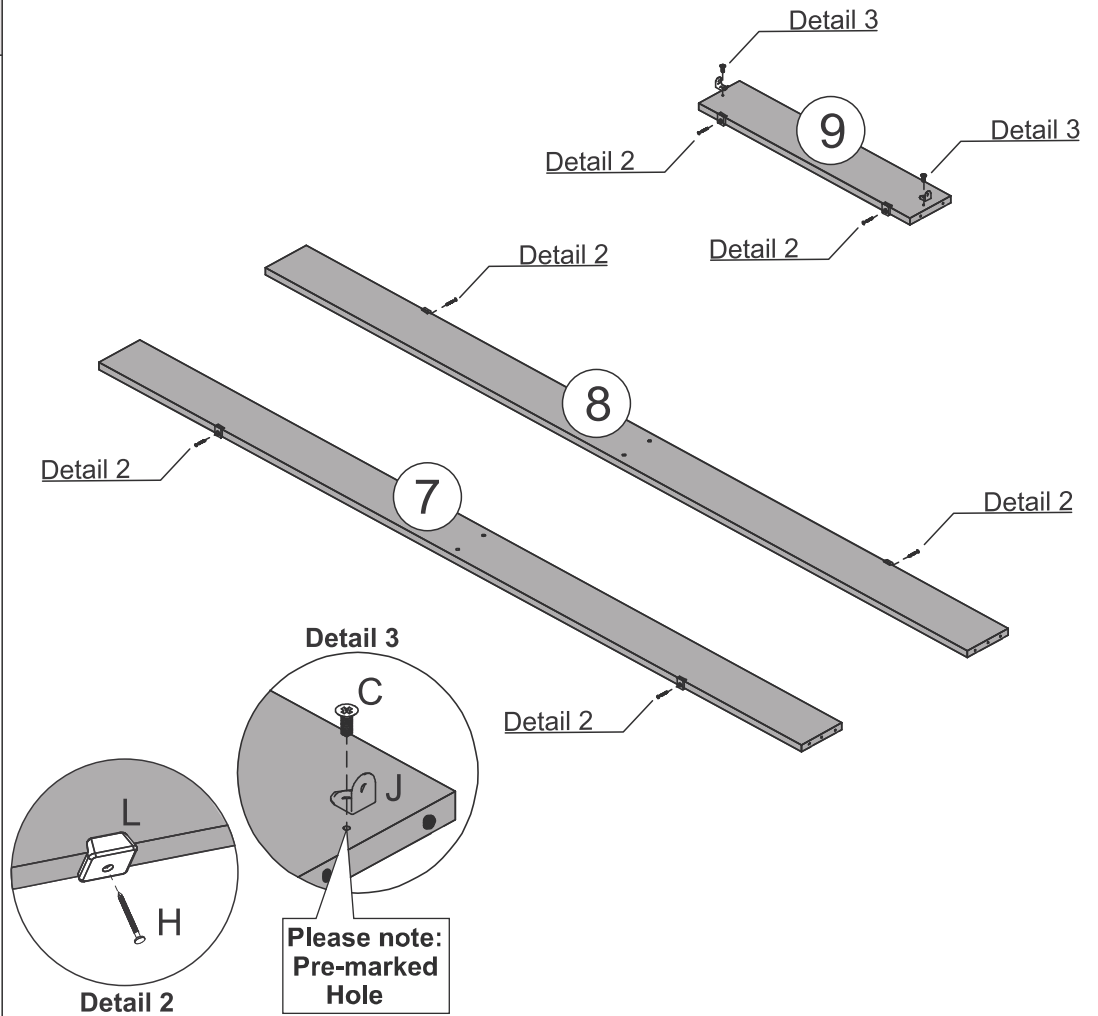
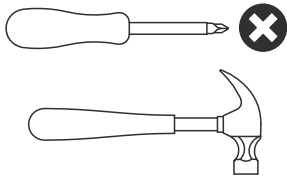



STEP 2

PARTS REQUIRED

7 - FRONT BASEBOARD	x1
8 - BACK BASEBOARD	x1
9 - CROSSBEAM	x1

HARDWARE REQUIRED

E		12
G		01
T		02

TOOLS REQUIRED

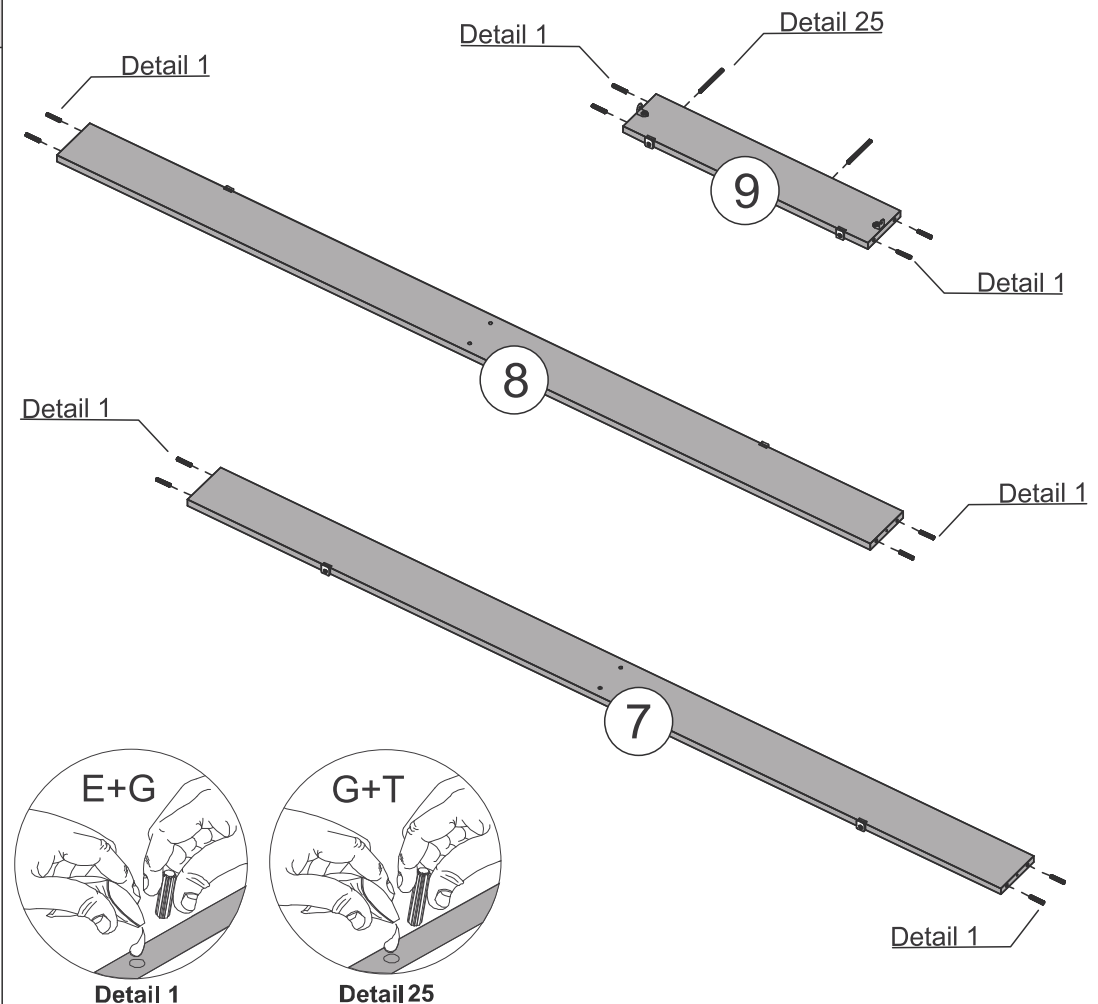
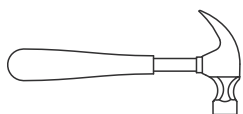

STEP 3

PARTS REQUIRED

1 - BASE PANEL x1

HARDWARE REQUIRED

A  02

E  04

G  01

TOOLS REQUIRED

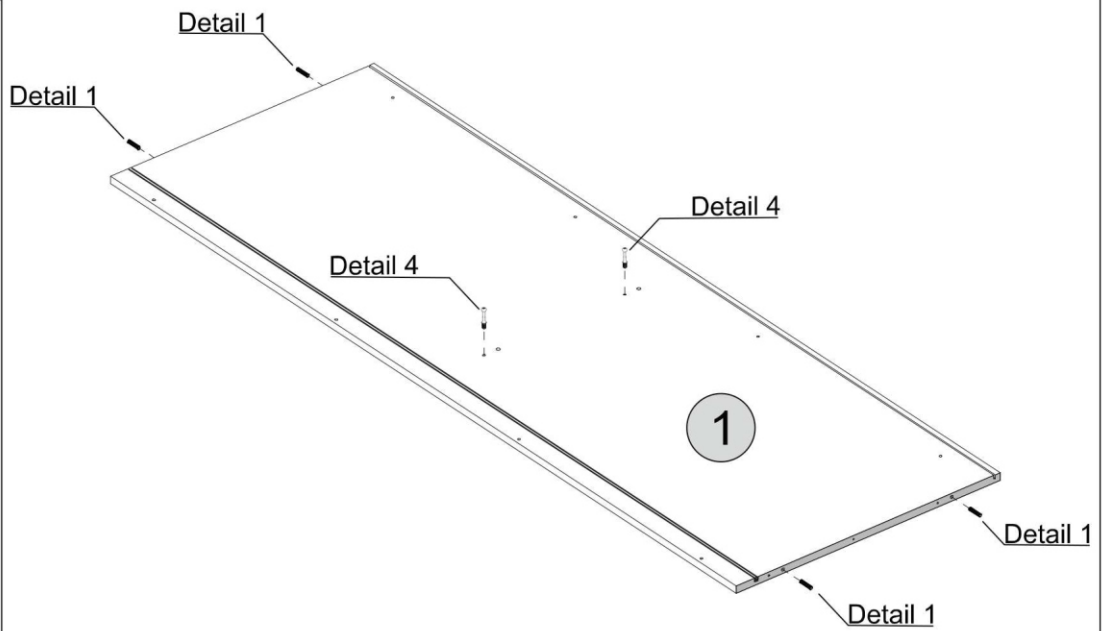
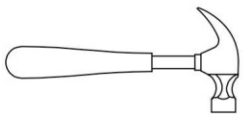
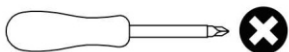

Detail 1

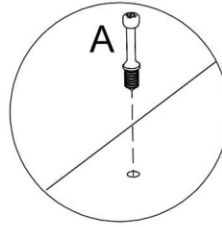

Detail 4

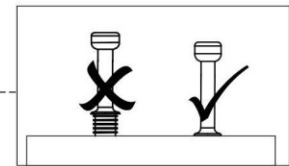

STEP 4

PARTS REQUIRED

1 - BASE PANEL x1

HARDWARE REQUIRED

O  04

V  01

TOOLS REQUIRED

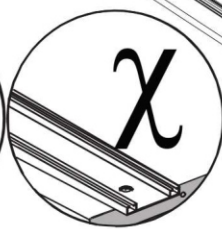
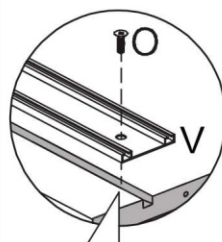
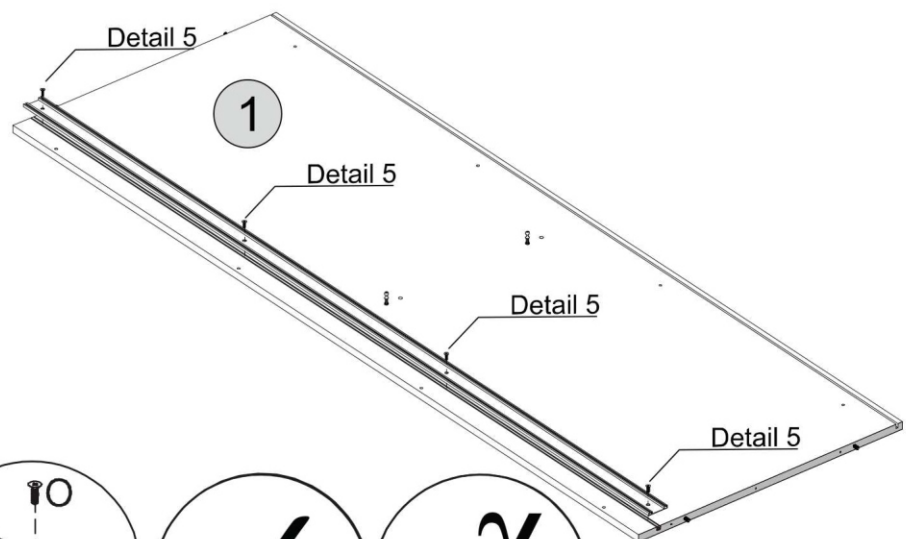
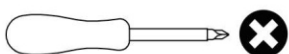

Please use the Groove as a guide for fixing





Detail 5

STEP 5

PARTS REQUIRED

6 - SHELF	x2
10- FRAME	x1

HARDWARE REQUIRED

C		02
E		08
G		01
J		02

TOOLS REQUIRED

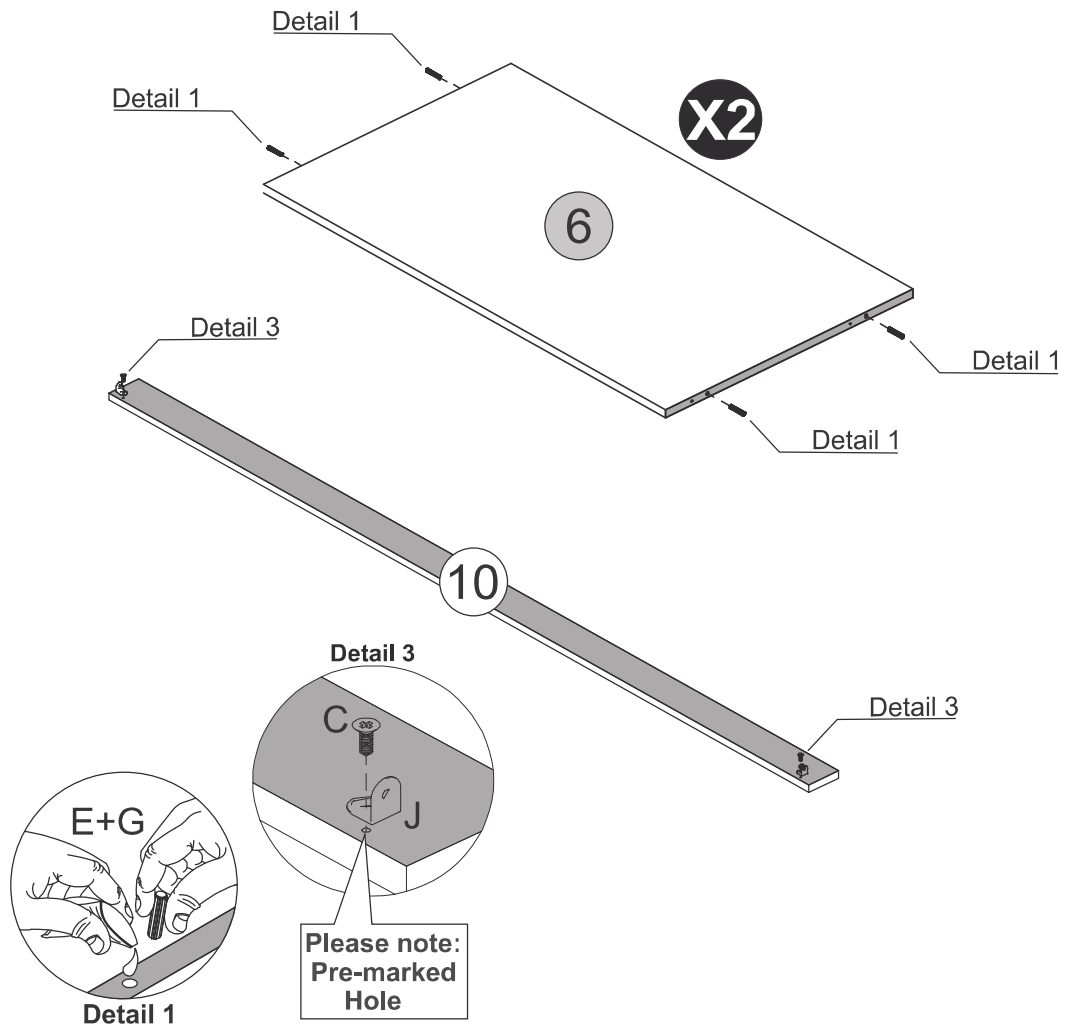
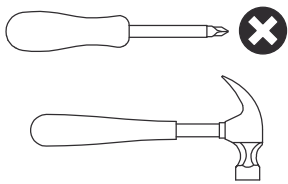





STEP 6

PARTS REQUIRED

2 - LEFT SIDE	x1
---------------	----

HARDWARE REQUIRED

C		02
H		02
L		02
M		01

TOOLS REQUIRED

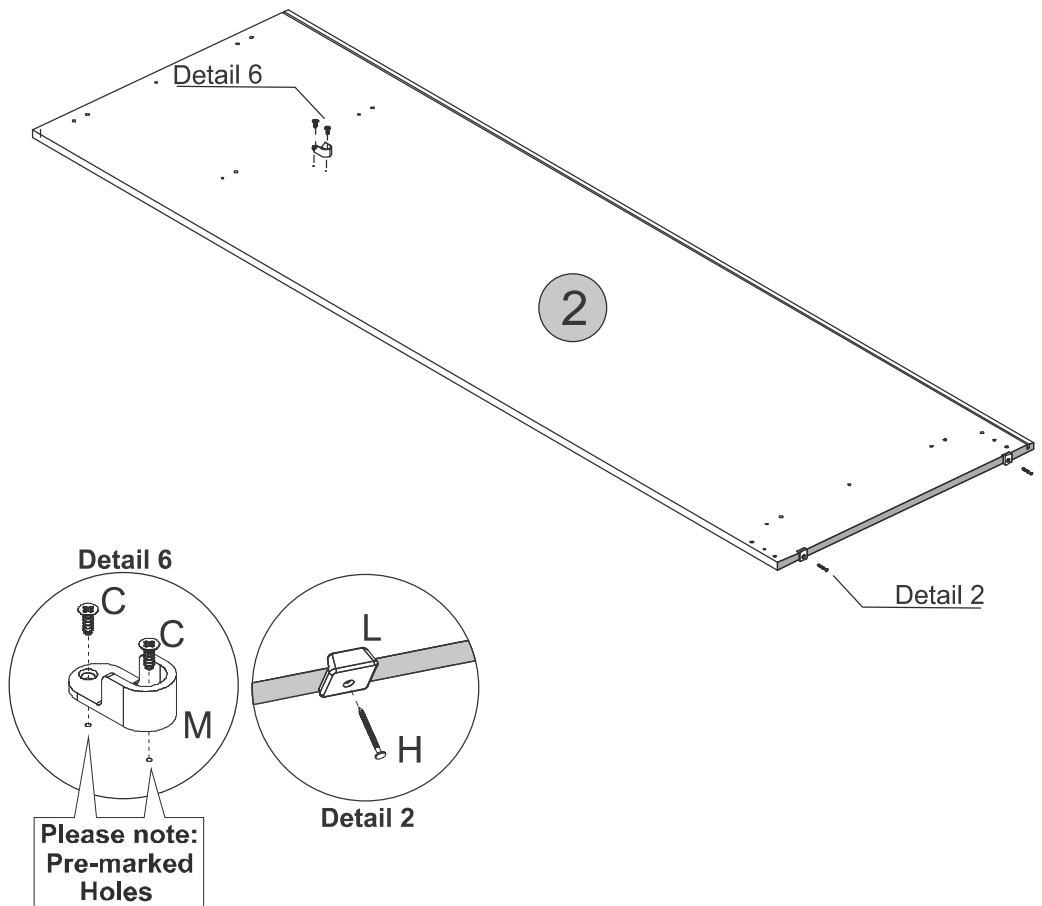
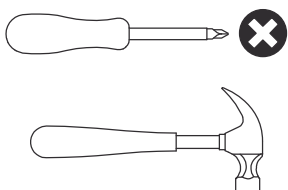

STEP 7

PARTS REQUIRED

3 - RIGHT SIDE x1

HARDWARE REQUIRED

C  02

H  02

L  02

M  01

TOOLS REQUIRED

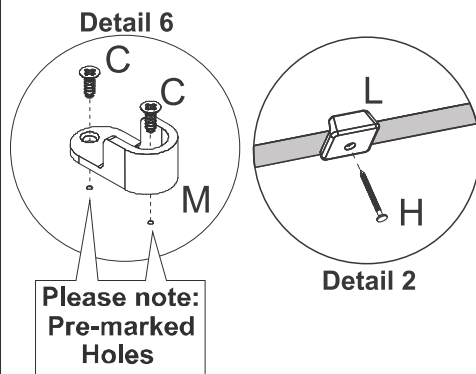
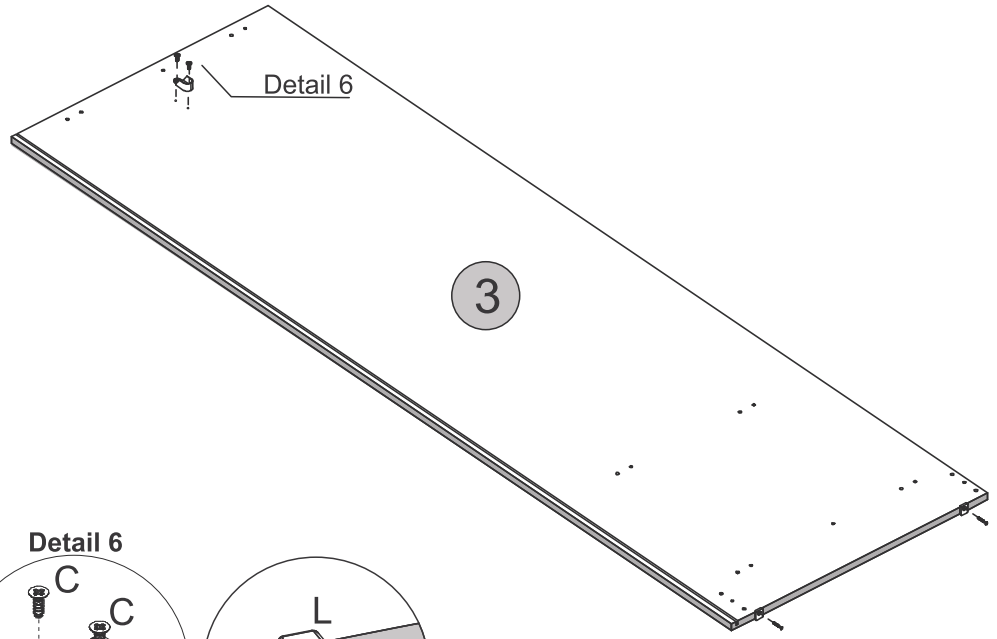
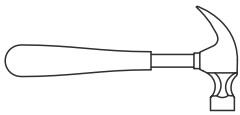
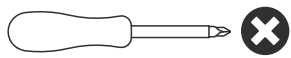

STEP 8

PARTS REQUIRED

5 - DIVISION PANEL x1

HARDWARE REQUIRED

C  02

E  02

G  01

M  01

TOOLS REQUIRED

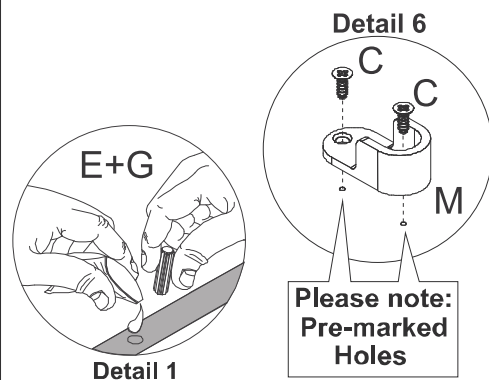
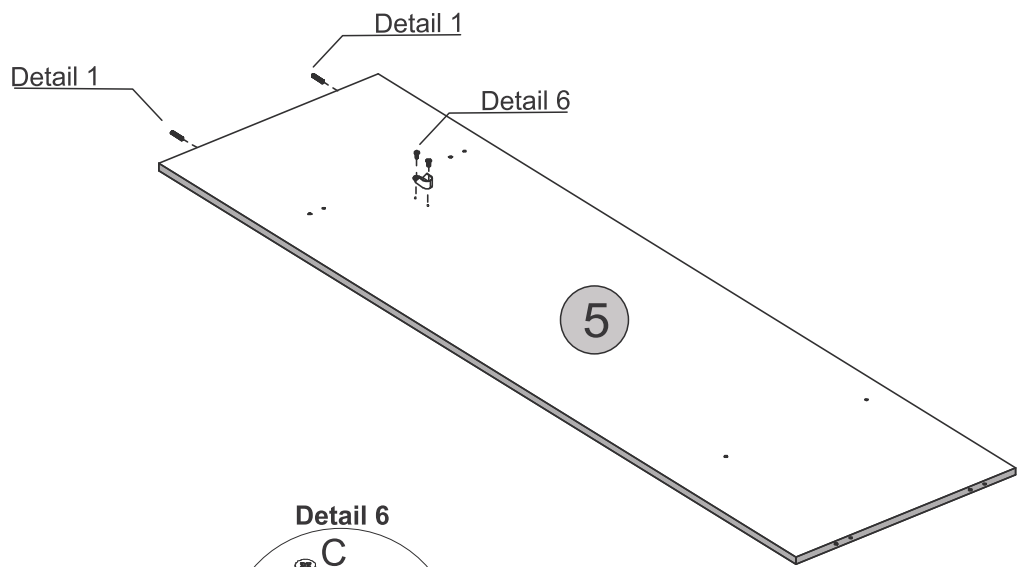
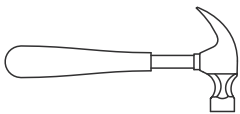
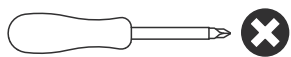

STEP 9

PARTS REQUIRED

5 - DIVISION PANEL x1

HARDWARE REQUIRED

C  02

M  01

TOOLS REQUIRED

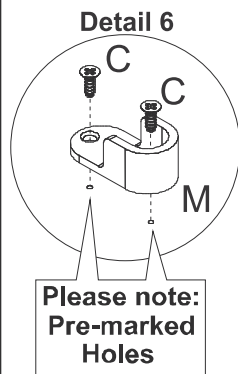
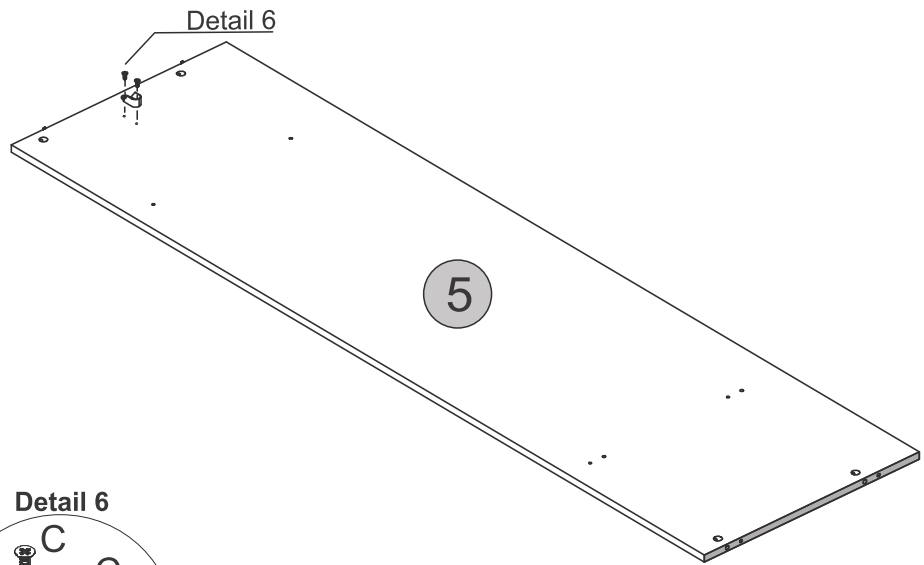

STEP 10

PARTS REQUIRED

4 - TOP PANEL x1

HARDWARE REQUIRED

C  04

E  04

G  01

J  04

TOOLS REQUIRED

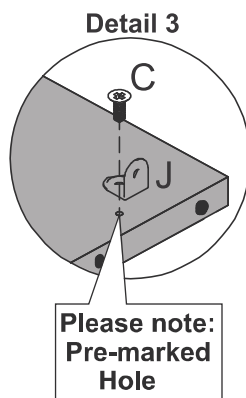
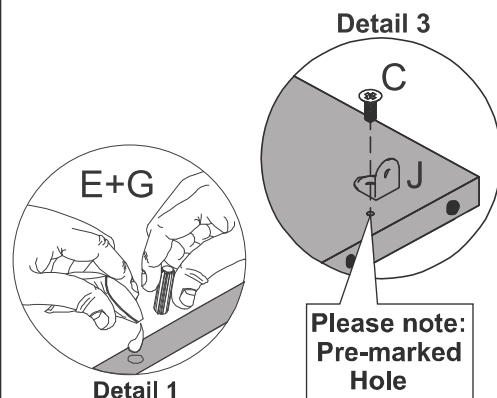
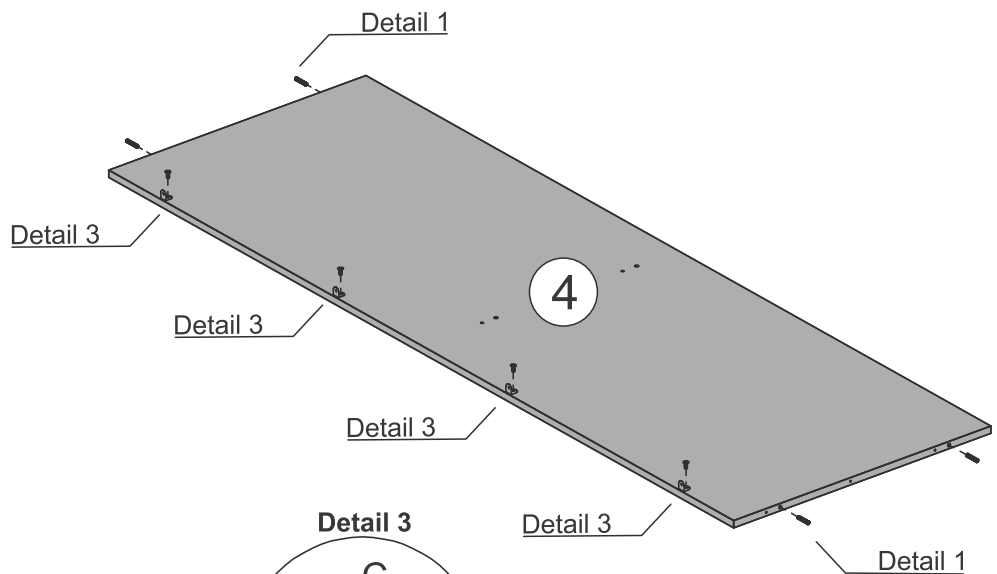
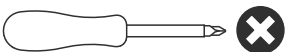



STEP 11

PARTS REQUIRED

4 - TOP PANEL x1

HARDWARE REQUIRED

O  05

X  01

TOOLS REQUIRED

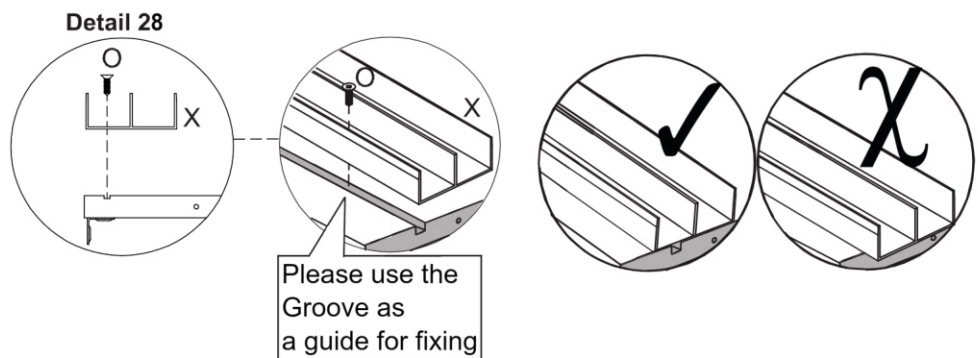
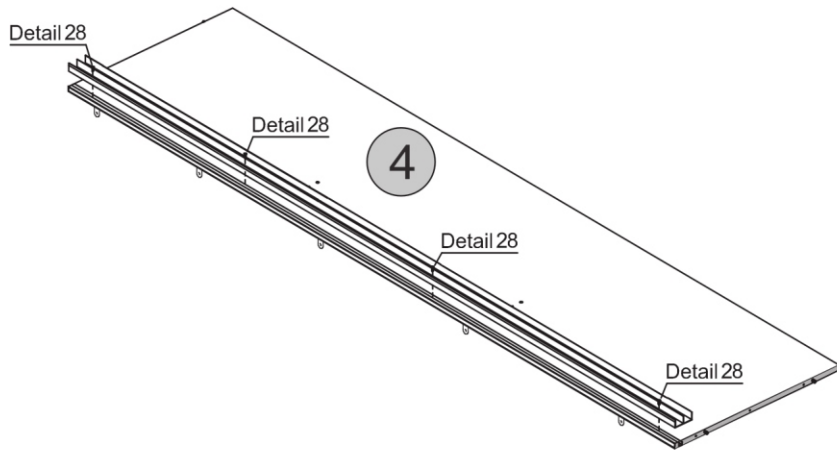



STEP 12

PARTS REQUIRED

4 - TOP PANEL x1

HARDWARE REQUIRED

A  02

O  05

X  01

TOOLS REQUIRED

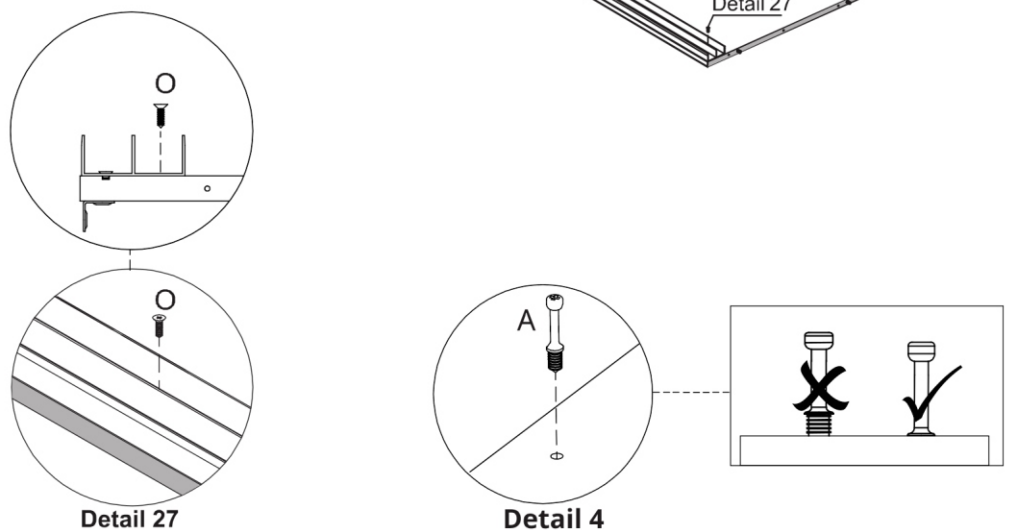
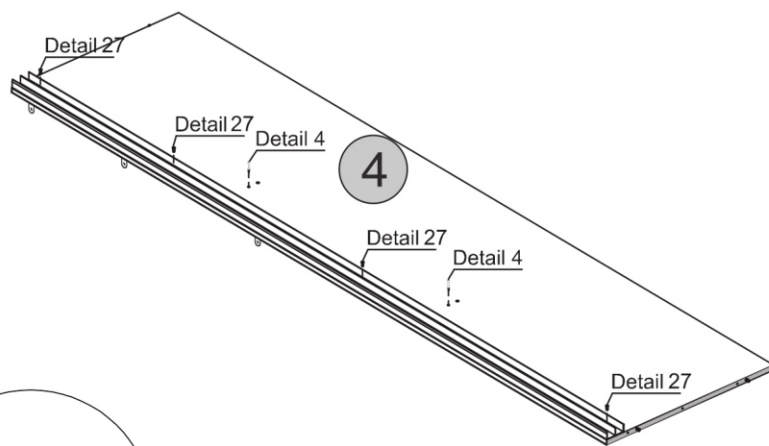



STEP 13

PARTS REQUIRED

7 - FRONT BASEBOARD	x1
8 - BACK BASEBOARD	x1
9 - CROSSBEAM	x1

HARDWARE REQUIRED

C		02
G		01

TOOLS REQUIRED

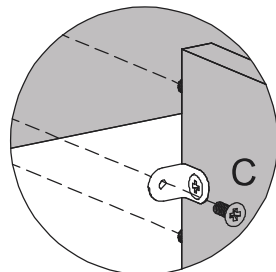
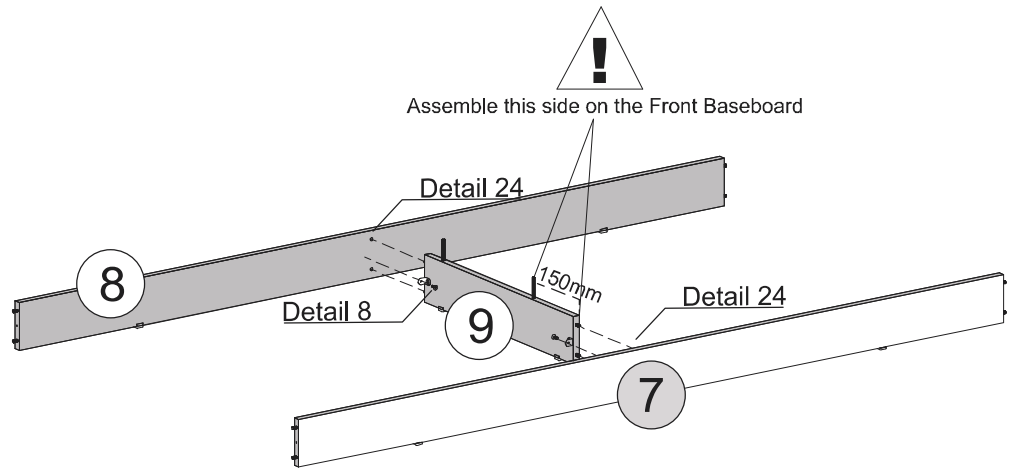
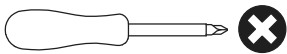

Detail 8

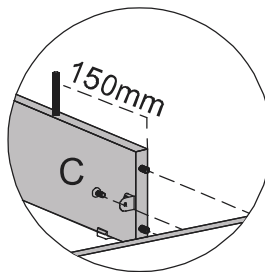

Detail 24



STEP 14

PARTS REQUIRED

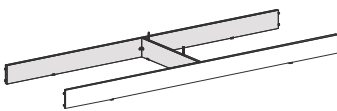
2 - LEFT SIDE	x1
---------------	----



HARDWARE REQUIRED

F		02
G		01
Q		02

TOOLS REQUIRED

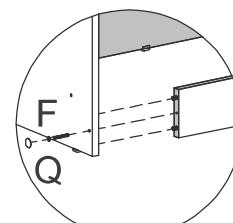
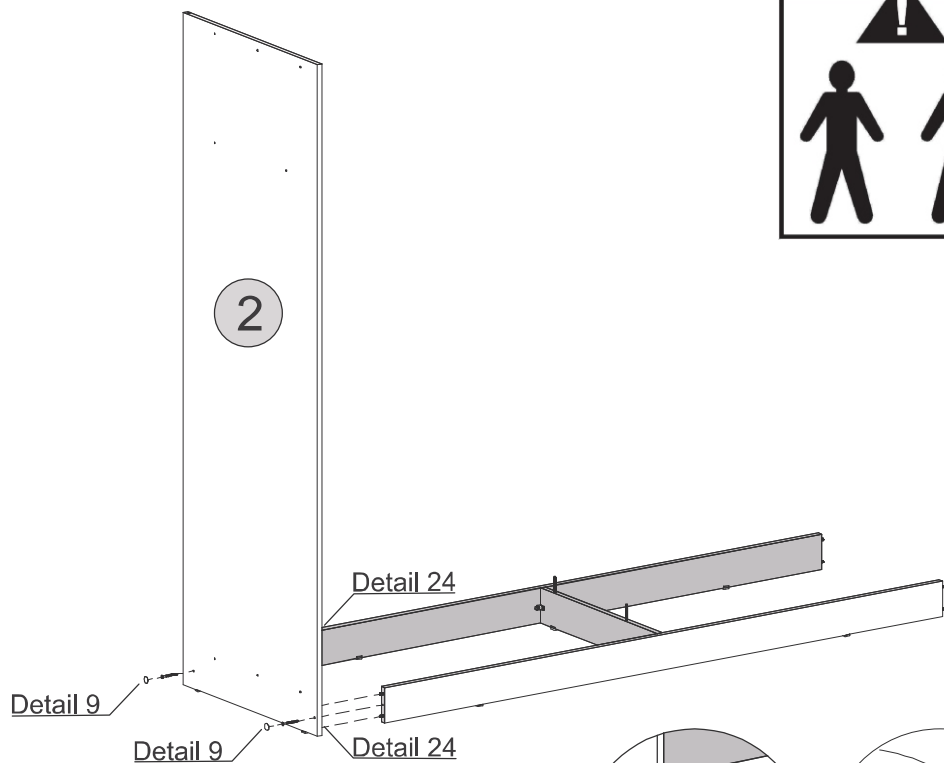
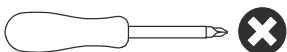

Detail 9

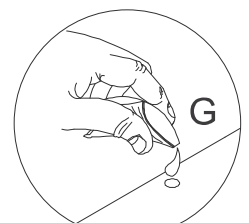

Detail 24

STEP 15

PARTS REQUIRED

1 - BASE PANEL x1

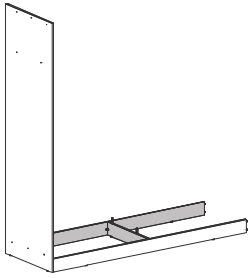

HARDWARE REQUIRED

F  03

G  01

Q  03

TOOLS REQUIRED

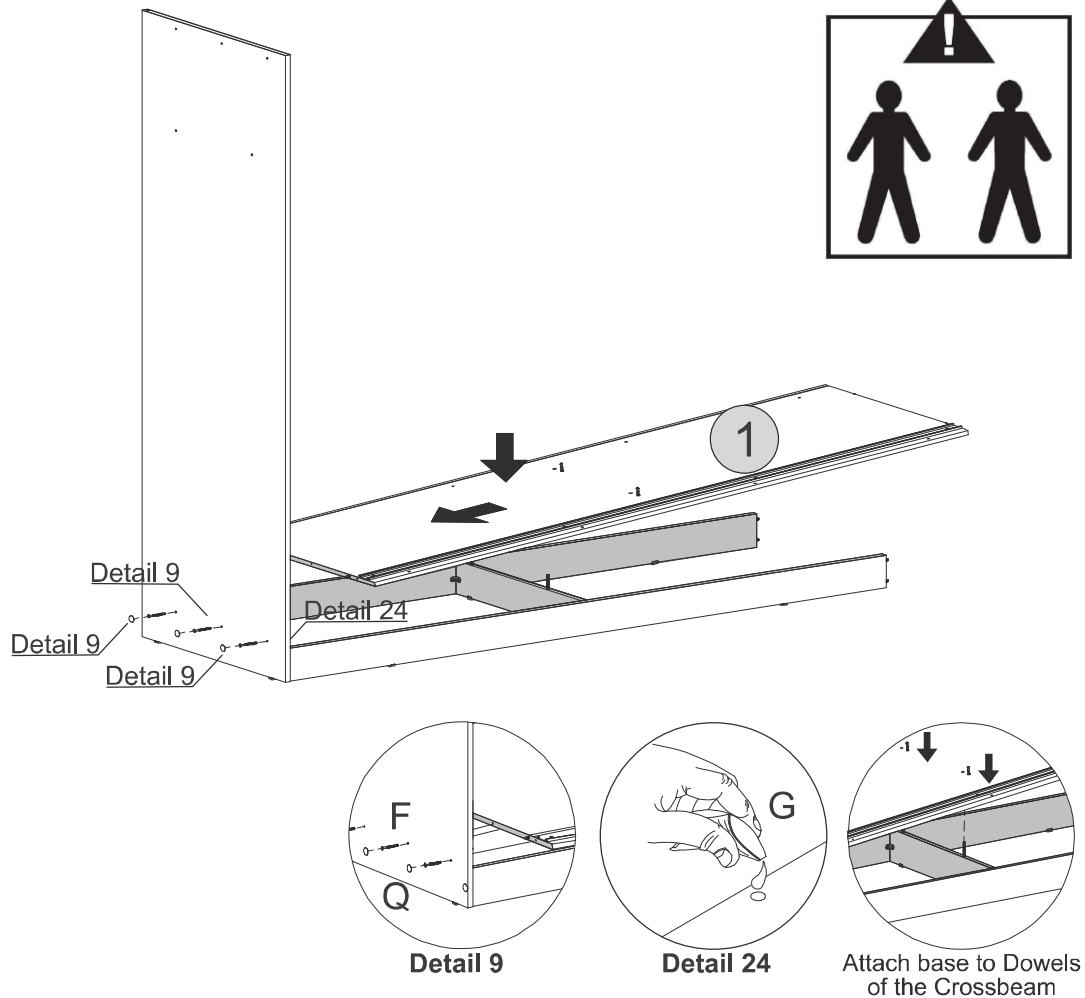
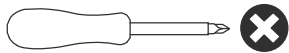

STEP 16

PARTS REQUIRED

3 - RIGHT SIDE x1

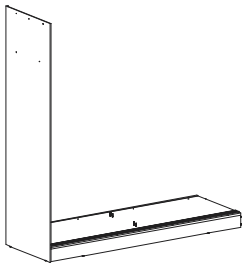

HARDWARE REQUIRED

F  05

G  01

Q  05

TOOLS REQUIRED

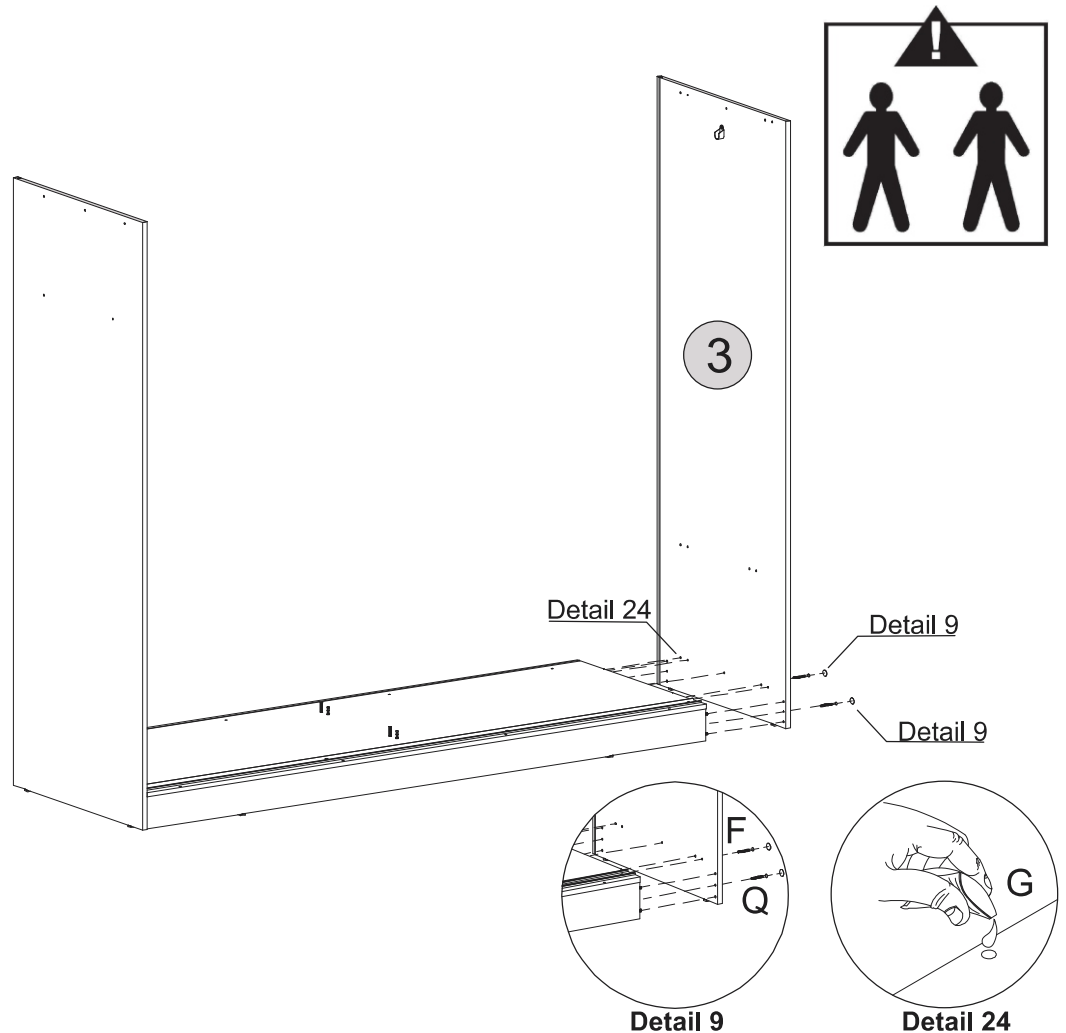
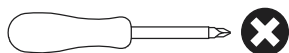

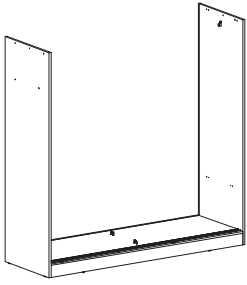

STEP 17

PARTS REQUIRED



HARDWARE REQUIRED

- Q  08
- R  08

TOOLS REQUIRED

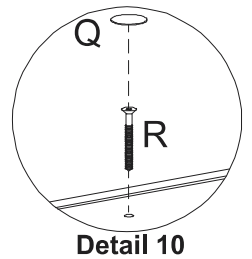
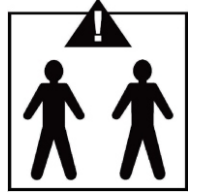
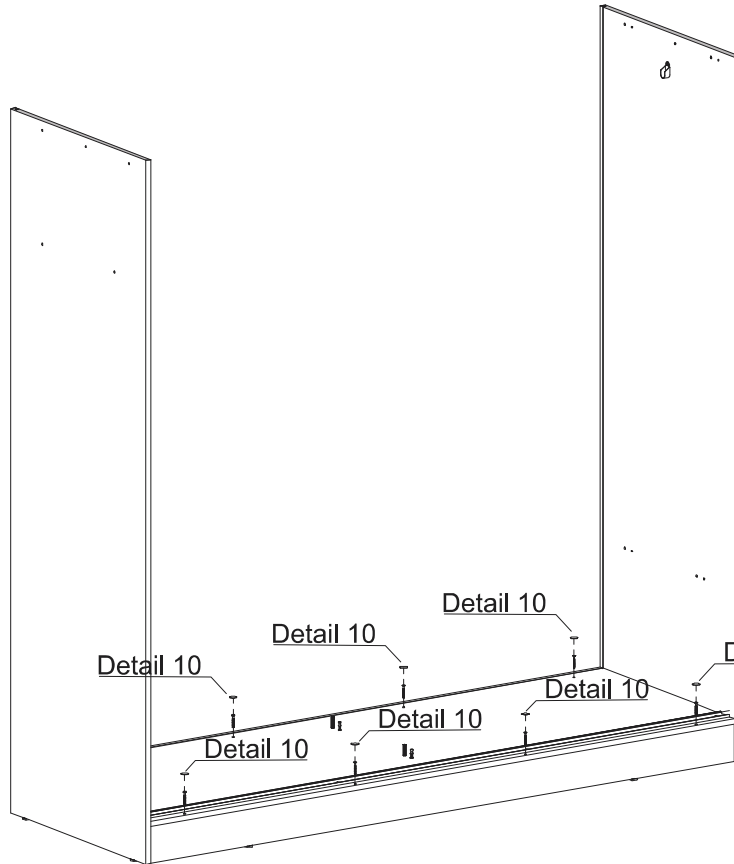
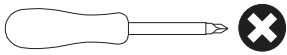



STEP 18

PARTS REQUIRED

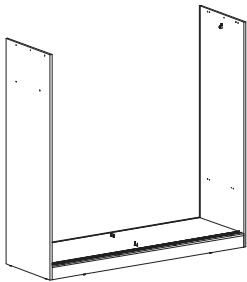
- 5 - DIVISION PANEL x1



HARDWARE REQUIRED

- B  02
- G  01
- Q  02

TOOLS REQUIRED

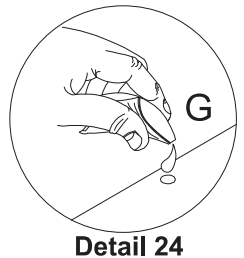
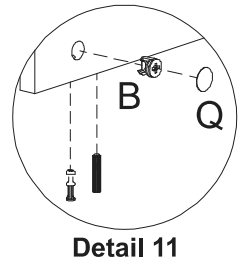
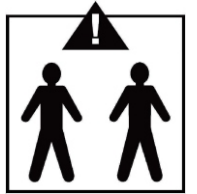
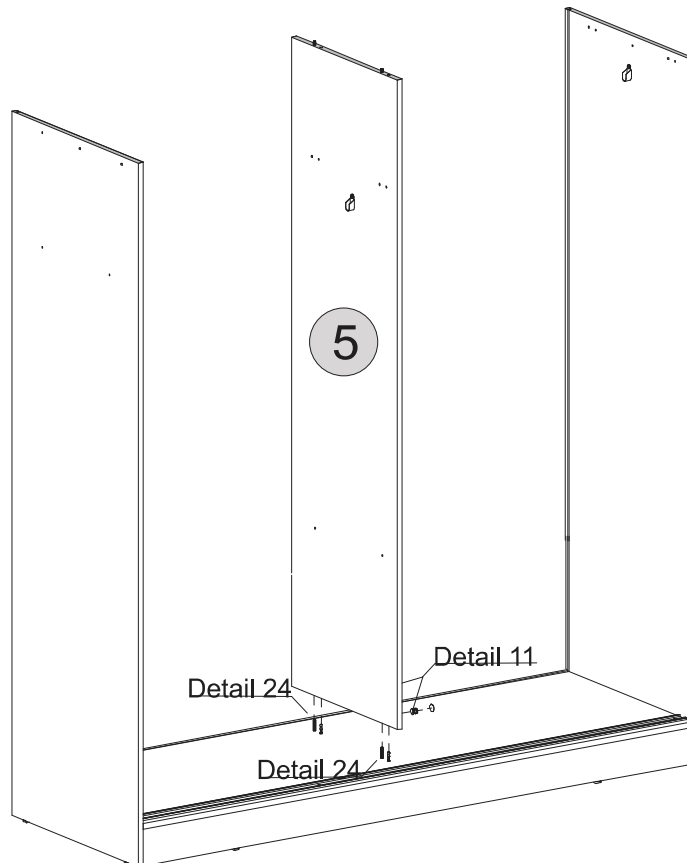
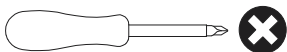



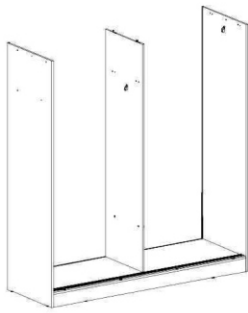

STEP 19

PARTS REQUIRED

6 - SHELF x2



HARDWARE REQUIRED

- F  08
- G  01
- Q  04
- C1  04

TOOLS REQUIRED

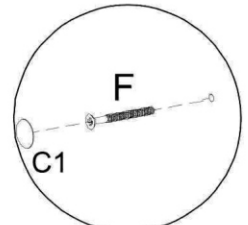
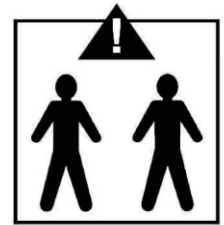
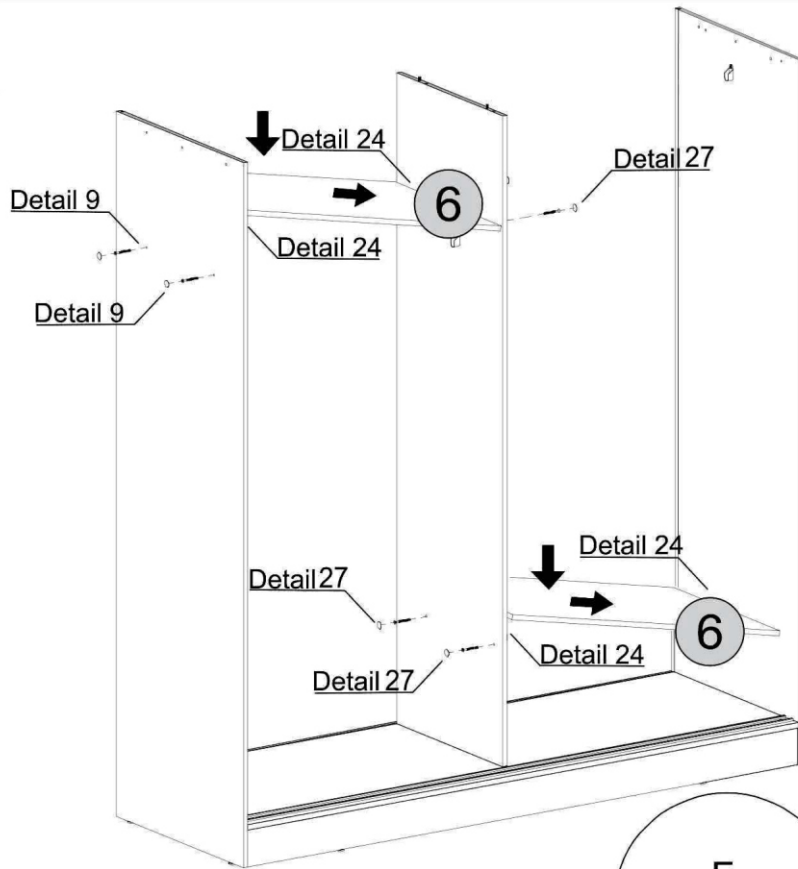
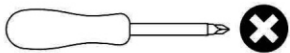

Detail 27

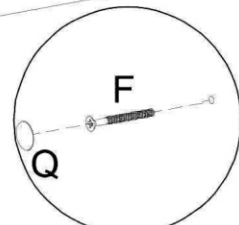

Detail 9

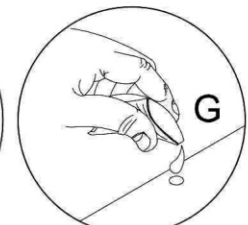

Detail 24





STEP 20

PARTS REQUIRED

4 - TOP PANEL x1

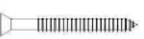

HARDWARE REQUIRED

- B  02
- F  06
- G  01
- Q  06
- C1  02

TOOLS REQUIRED

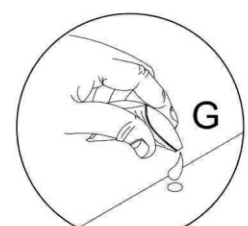
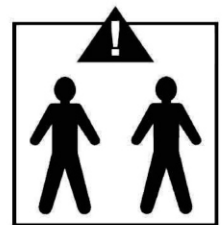
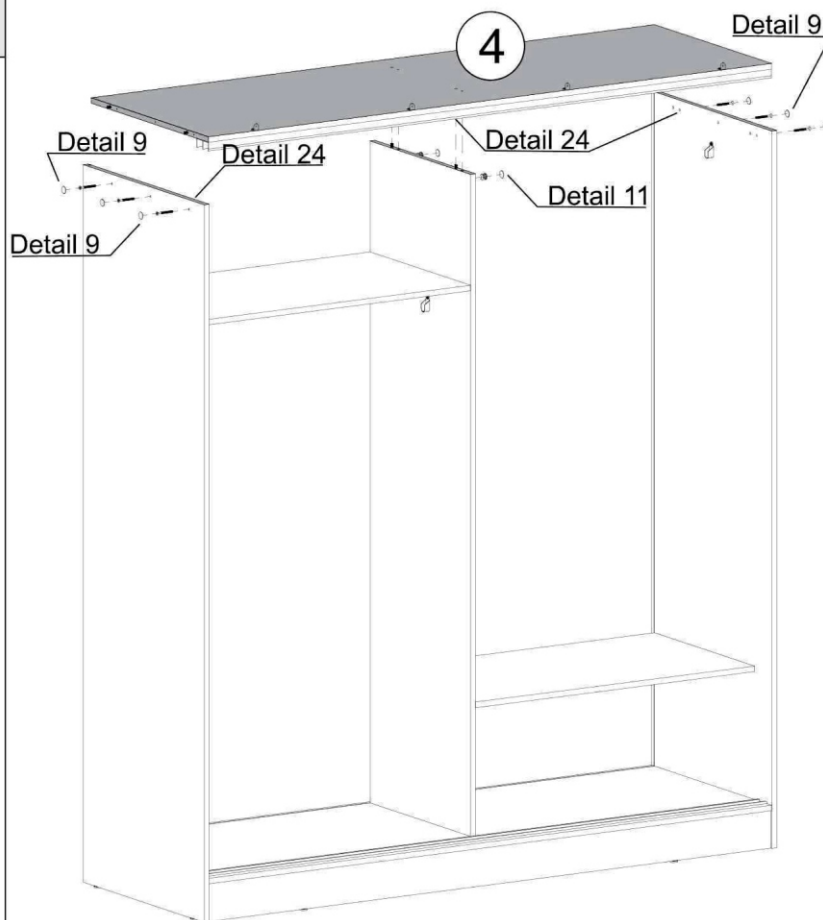
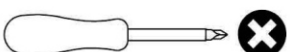

Detail 24

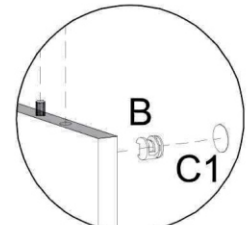

Detail 11

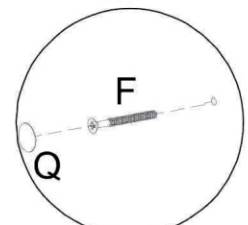

Detail 9

STEP 21

PARTS REQUIRED

13 - BACK PANEL x2

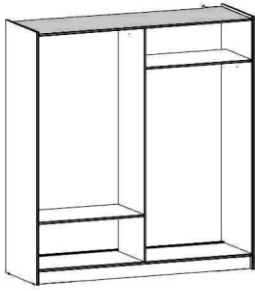

HARDWARE REQUIRED

H 06

TOOLS REQUIRED

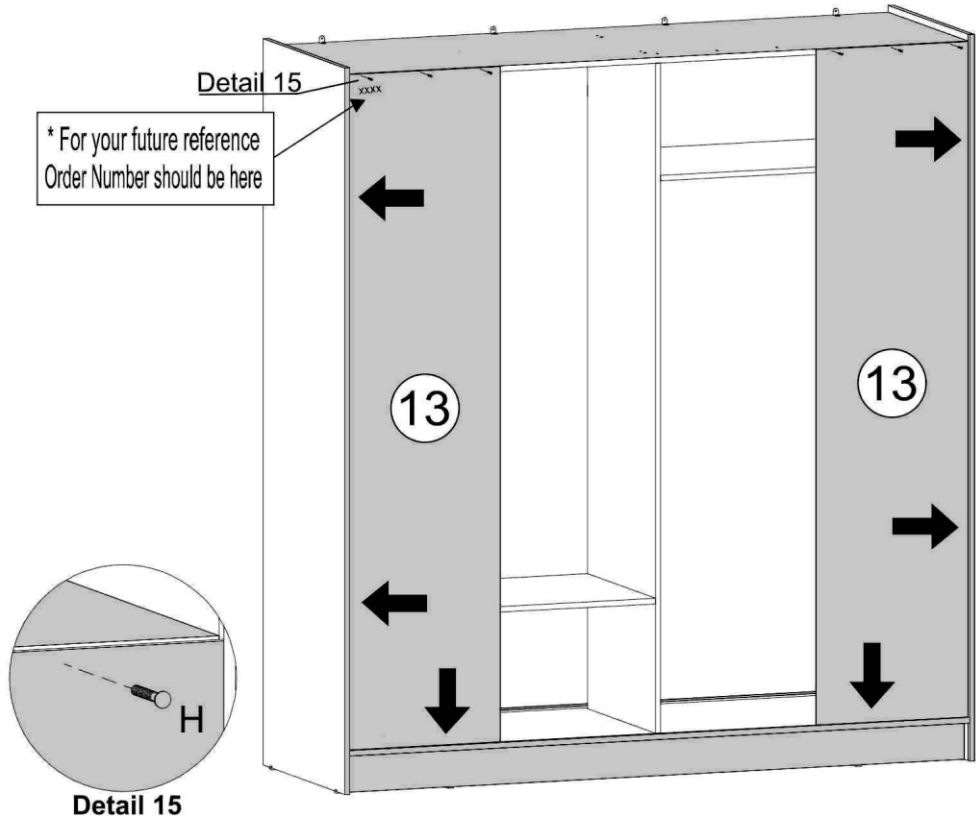
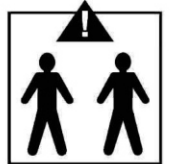
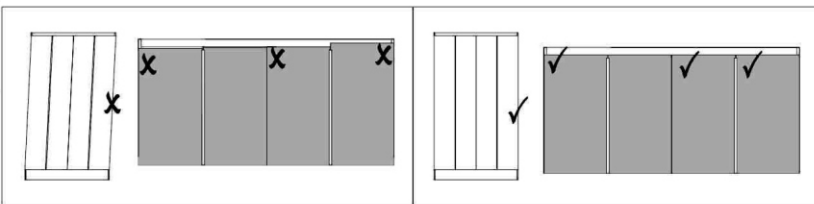
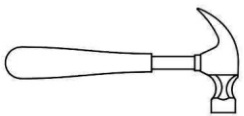

Detail 15

STEP 22

PARTS REQUIRED

13 - BACK PANEL x2

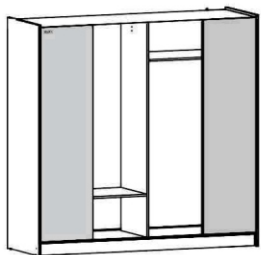

HARDWARE REQUIRED

H 17

I 11

A1 02

TOOLS REQUIRED

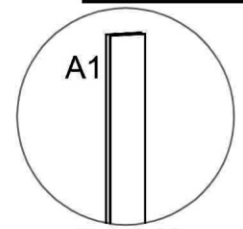
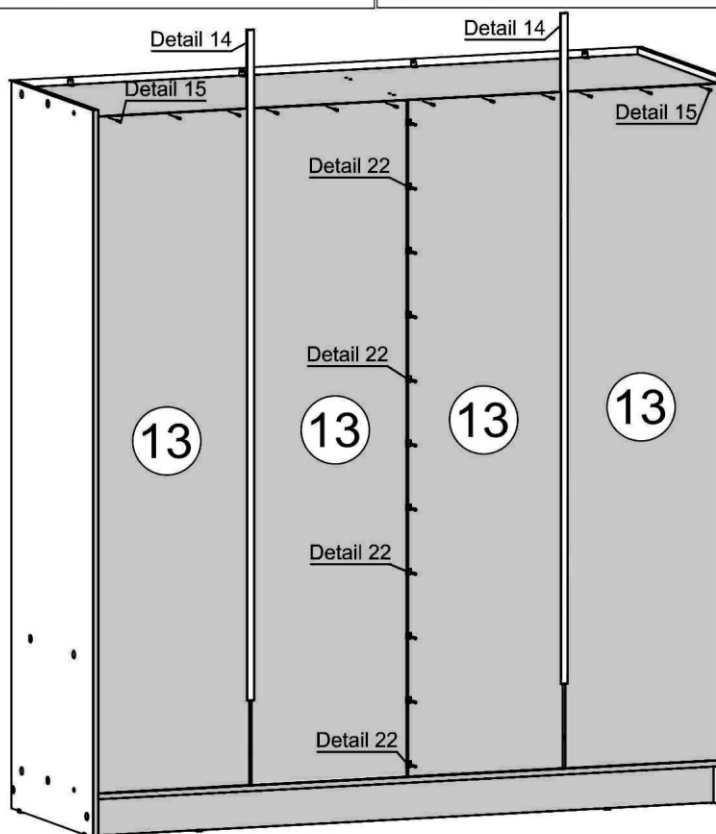
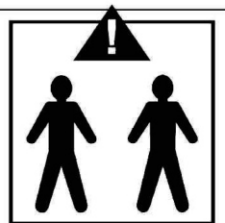
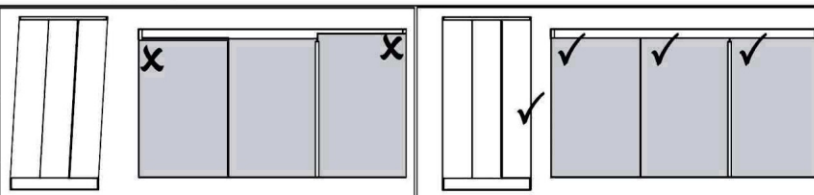
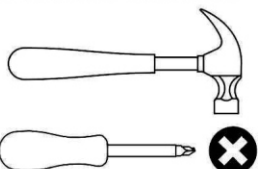

Detail 14

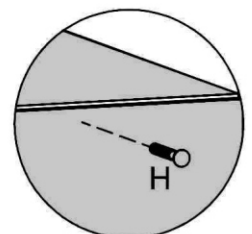

Detail 15

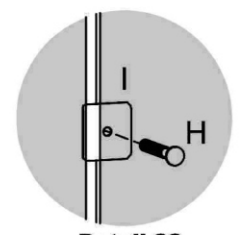

Detail 22

STEP 23

PARTS REQUIRED

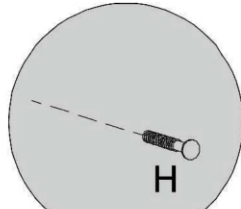
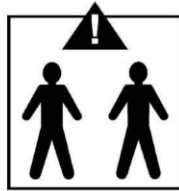
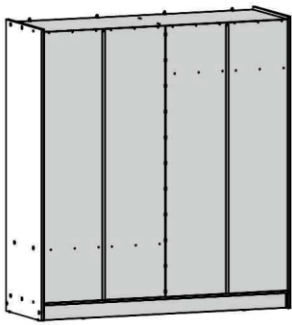

Detail 15

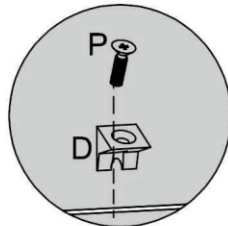

Detail 20

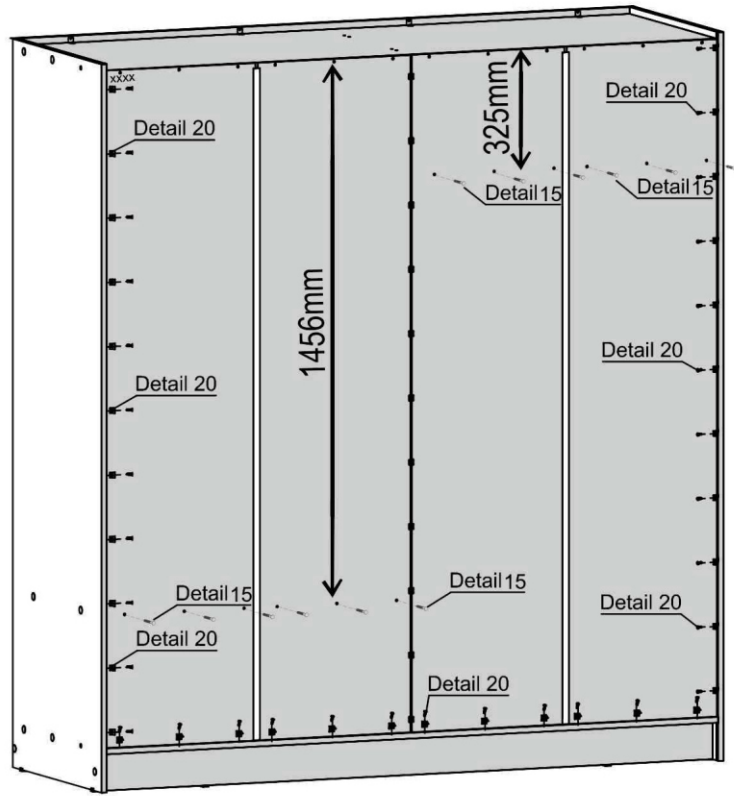

HARDWARE REQUIRED

D  34

H  12

P  34

TOOLS REQUIRED

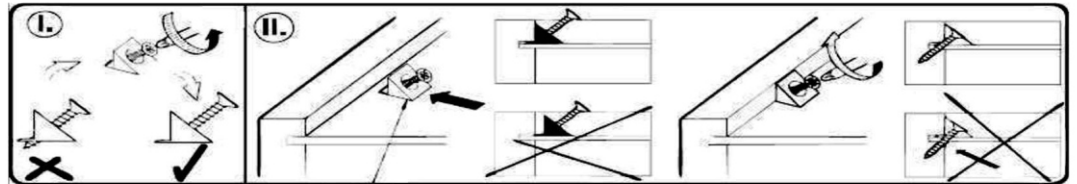
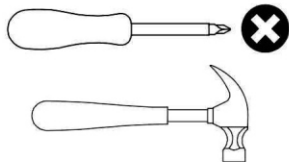

STEP 24

PARTS REQUIRED



HARDWARE REQUIRED

W  02

Y  01

B1  04

B1  04

TOOLS REQUIRED

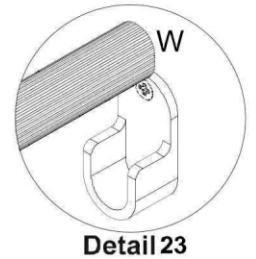
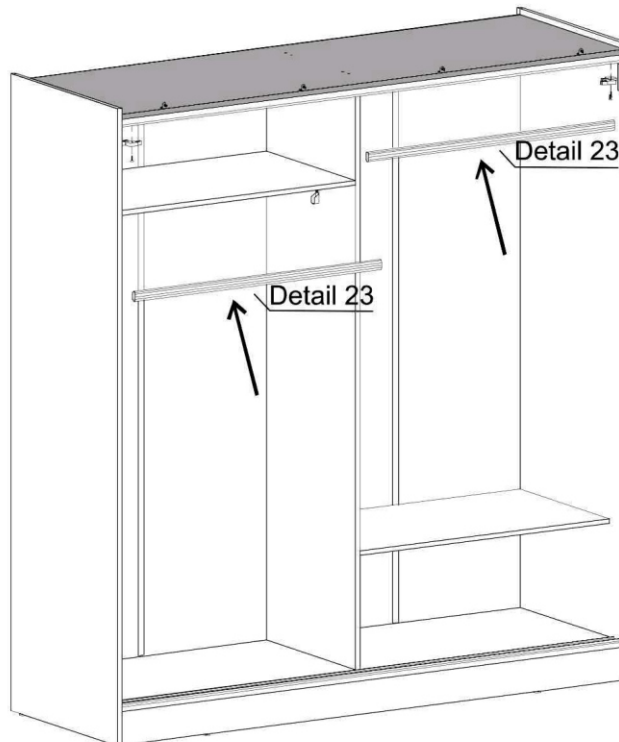
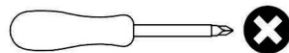

Detail 23

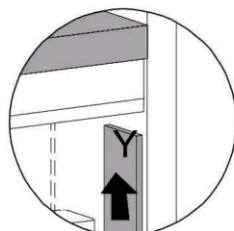

USE TEMPLATE (Y) TO ASSEMBLE THE SLIDING SYSTEM BRAKE

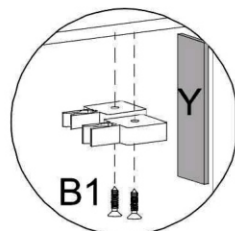

MAKE THIS ASSEMBLY ON BOTH SIDES OF THE WARDROBE

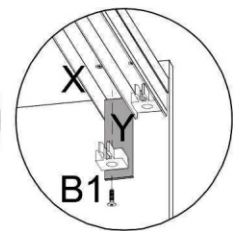
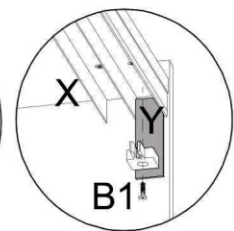

STEP 25

PARTS REQUIRED

10 - FRAME x1

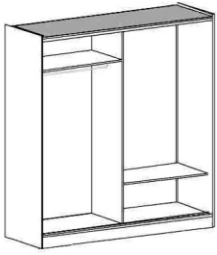

HARDWARE REQUIRED

C  02

TOOLS REQUIRED

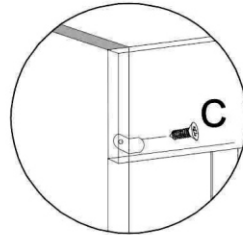
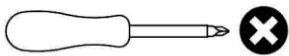

Detail 13

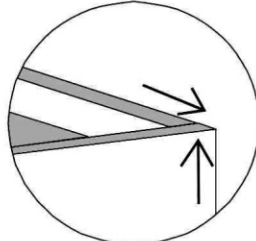

Align Corners

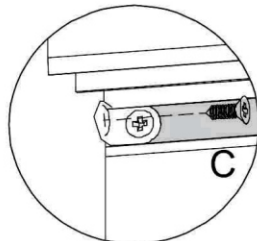

Detail 13

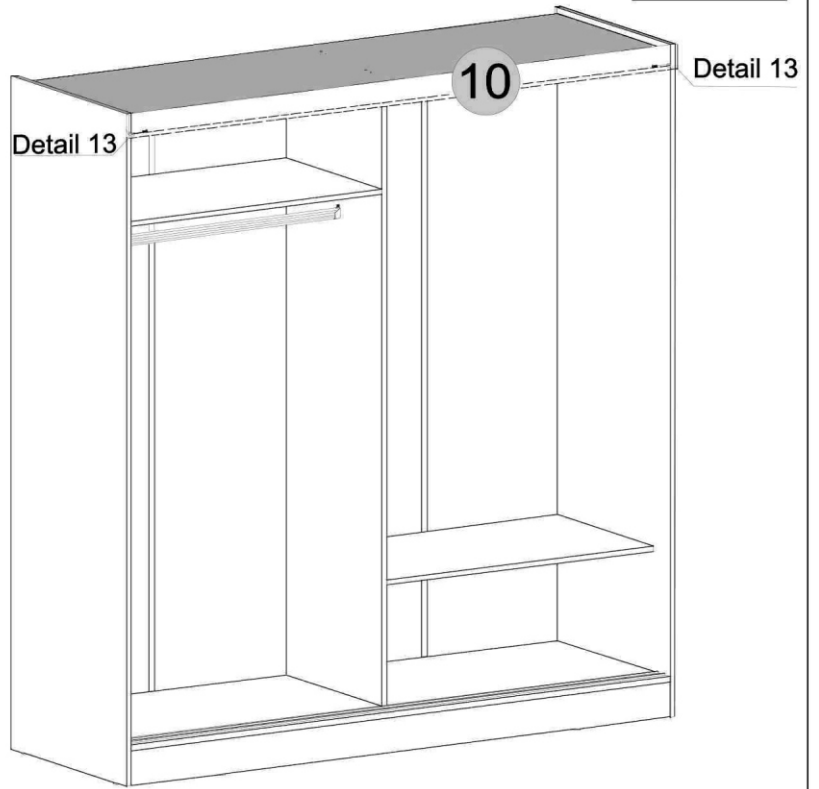

STEP 26

PARTS REQUIRED

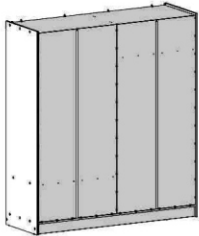

HARDWARE REQUIRED

C  08

J  02

TOOLS REQUIRED

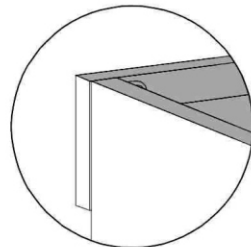
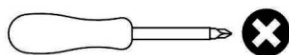

Measure from View to Top

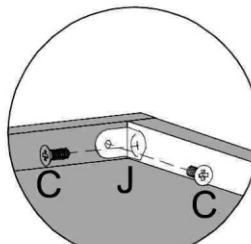
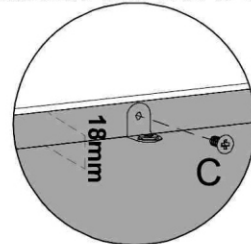

Detail 12

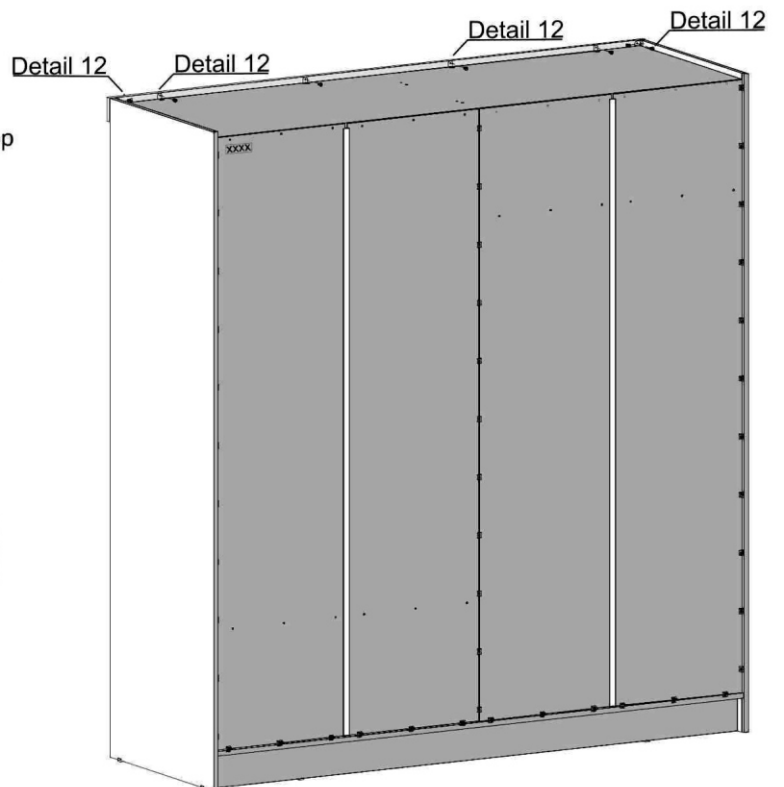

STEP 27

PARTS REQUIRED

11 - MIRRORED DOOR x1

12 - DOOR x1

HARDWARE REQUIRED

O  10

Z  02

TOOLS REQUIRED

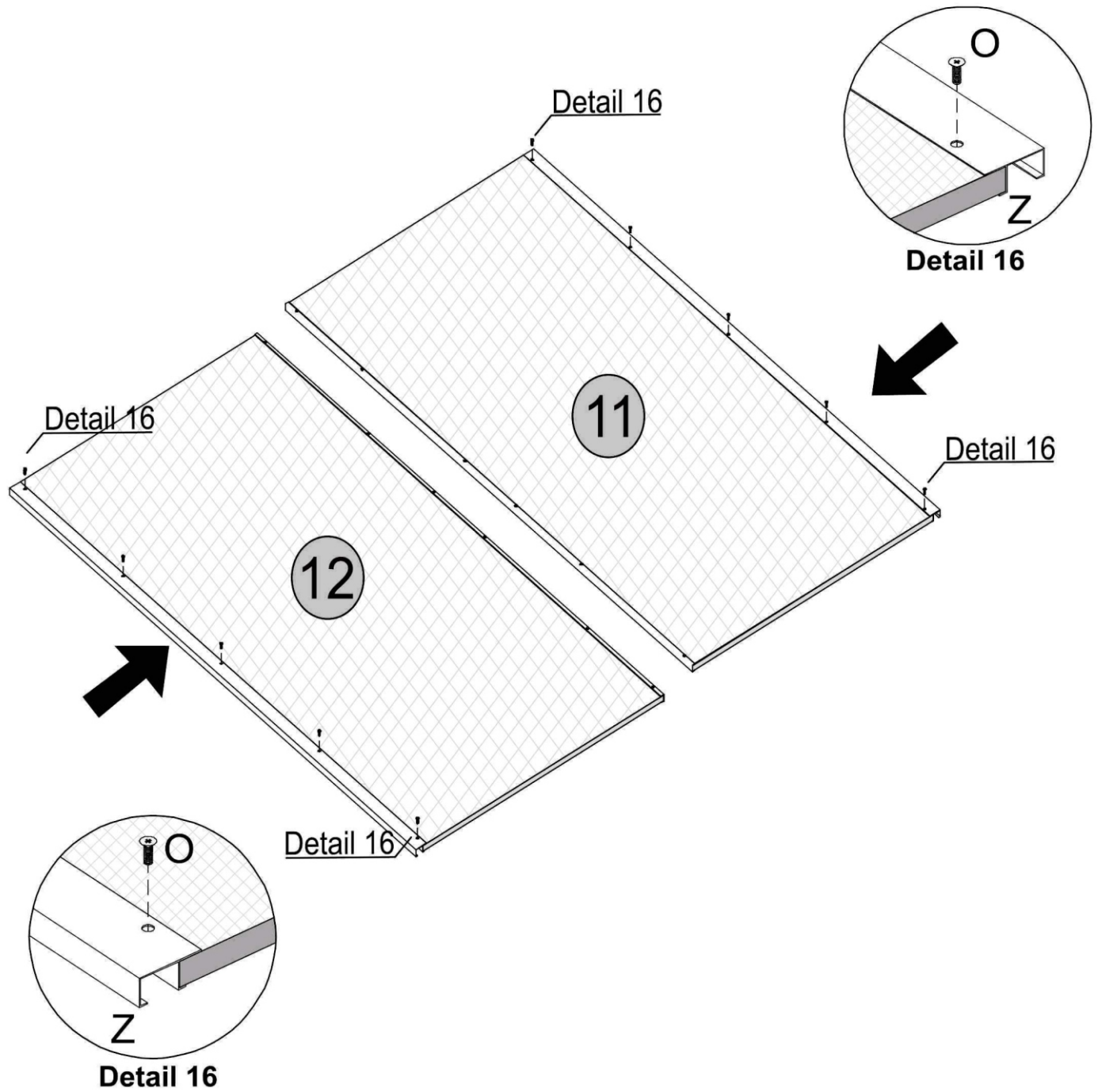
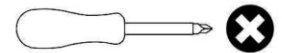

STEP 28

PARTS REQUIRED

HARDWARE REQUIRED

TOOLS REQUIRED

B1

SLIDING SYSTEM KIT

x2

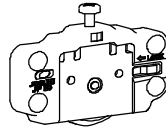

Lower Roller Latch x4

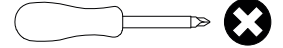

1° UNSCREW

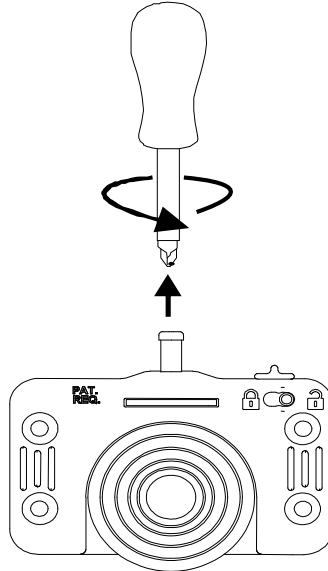

2° PUSH THE WHEEL UP UNTIL IT TOUCHES THE SCREW

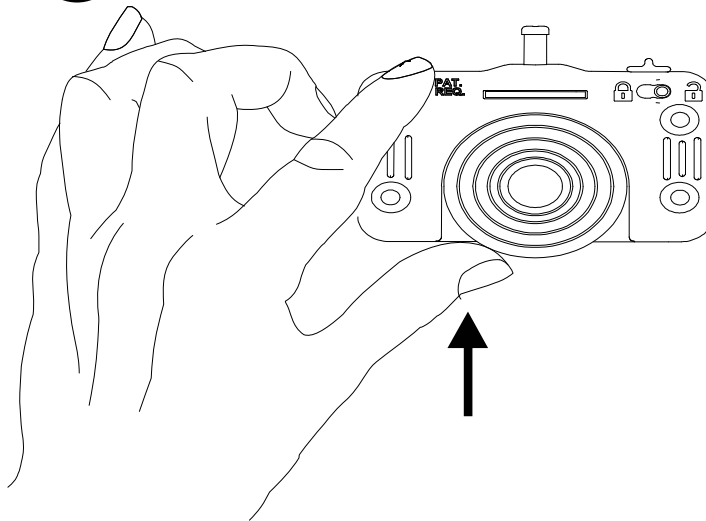

3° SLIDE TO LOCK

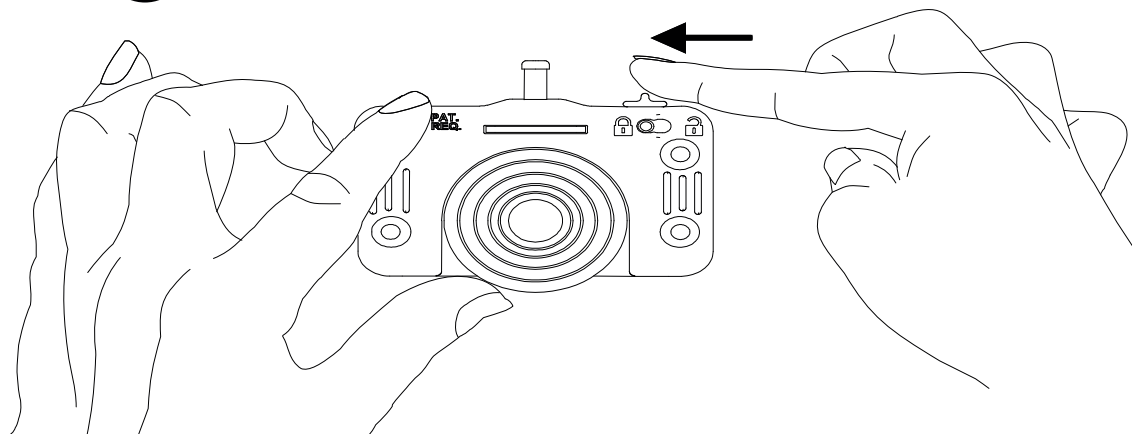

STEP 29

PARTS REQUIRED

11 - MIRRORED DOOR x1

12 - DOOR x1

HARDWARE REQUIRED

B1 **SLIDING SYSTEM KIT** **x2**

Lower Roller Latch x4

Upper Roller Latch x4

Screw Ø3.5 x 16 mm x24

TOOLS REQUIRED

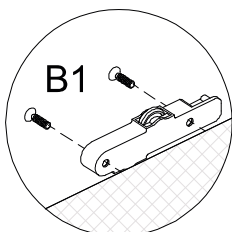
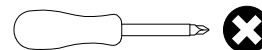

Detail 19

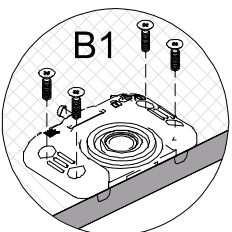
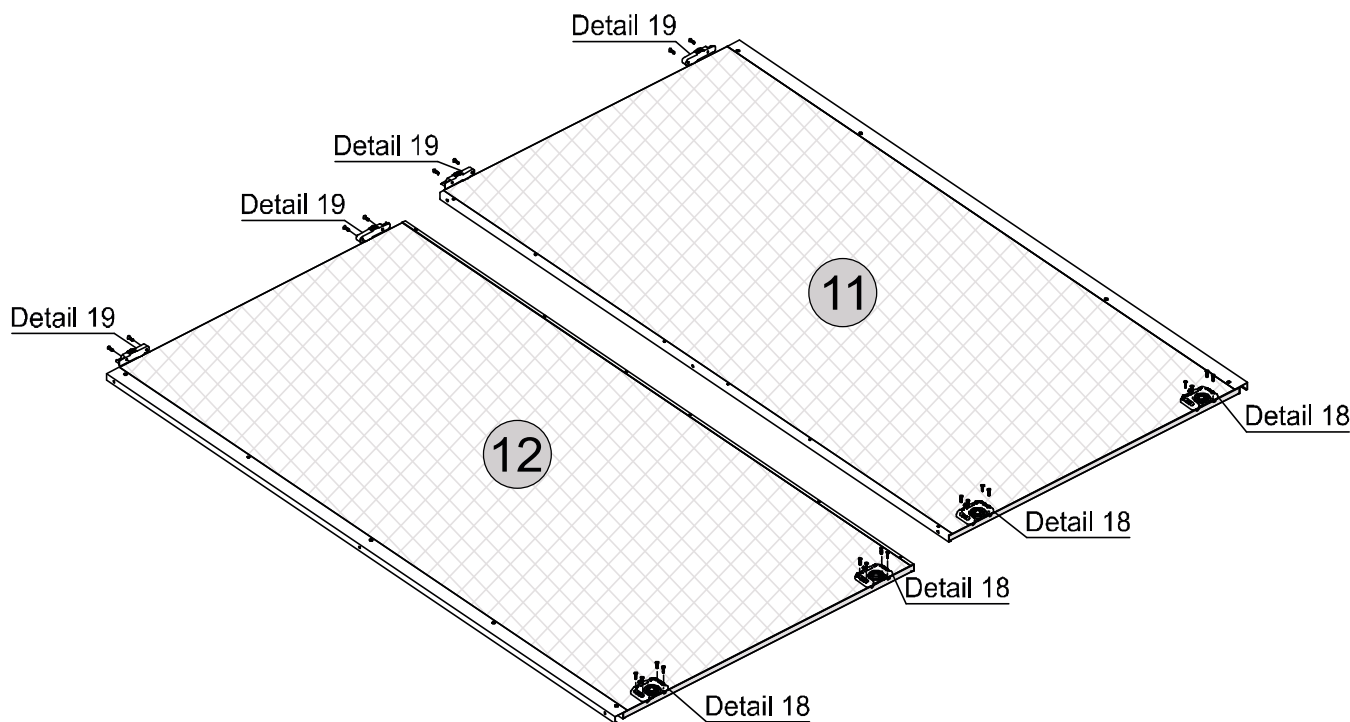
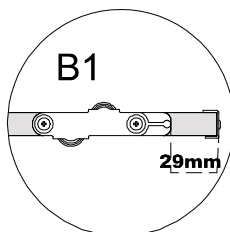
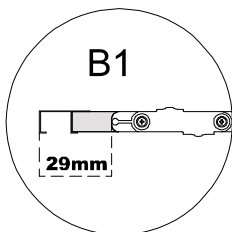

Detail 16

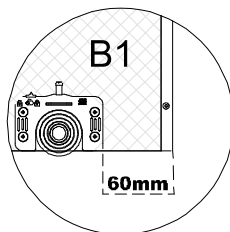
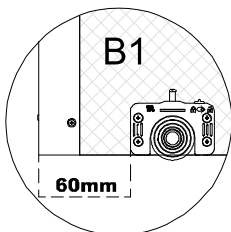

ATTENTION

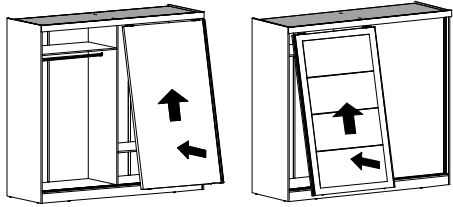

1° *Fit the Door*

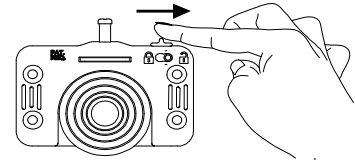

2° *Unlock the Pulley*

STEP 30

PARTS REQUIRED

12 - DOOR x1

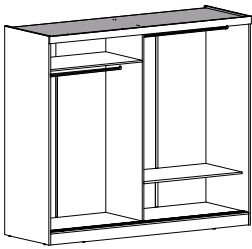

HARDWARE REQUIRED

TOOLS REQUIRED

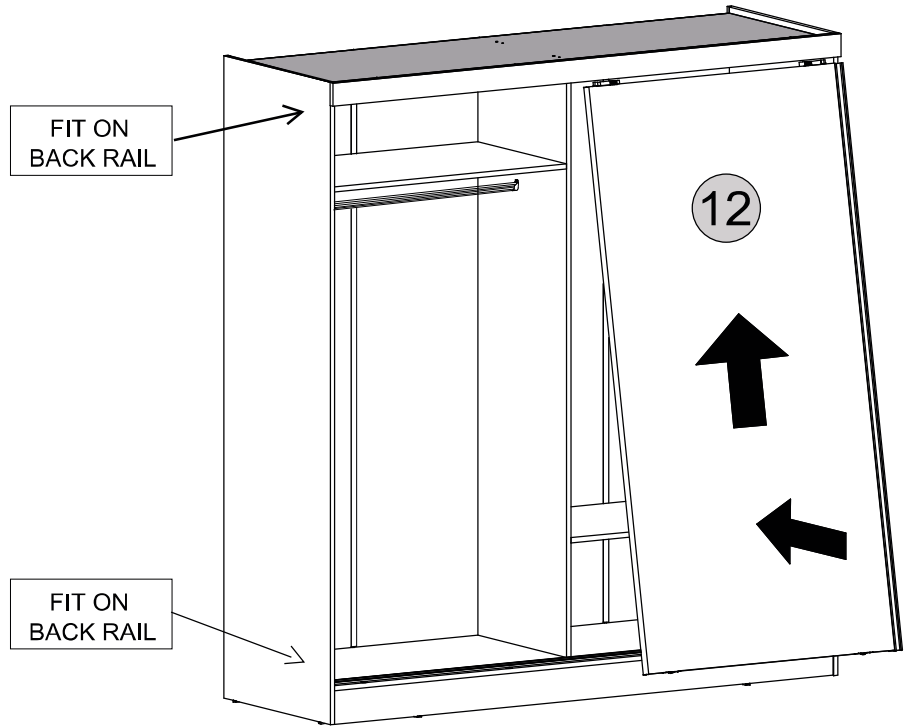

STEP 31

PARTS REQUIRED

11 - MIRRORED DOOR x1

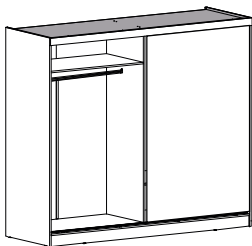

HARDWARE REQUIRED

TOOLS REQUIRED

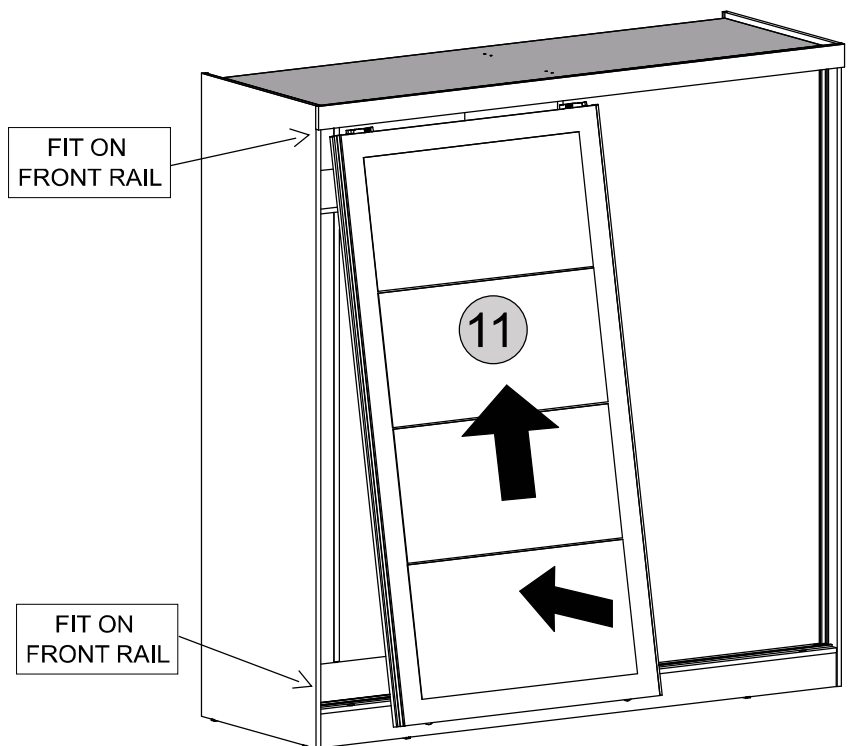

STEP 32

PARTS REQUIRED

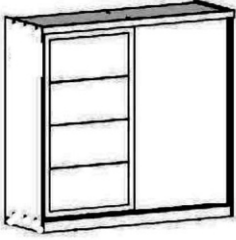

HARDWARE REQUIRED

U		12
---	--	----

TOOLS REQUIRED

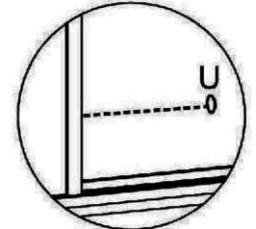
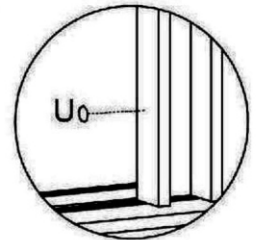
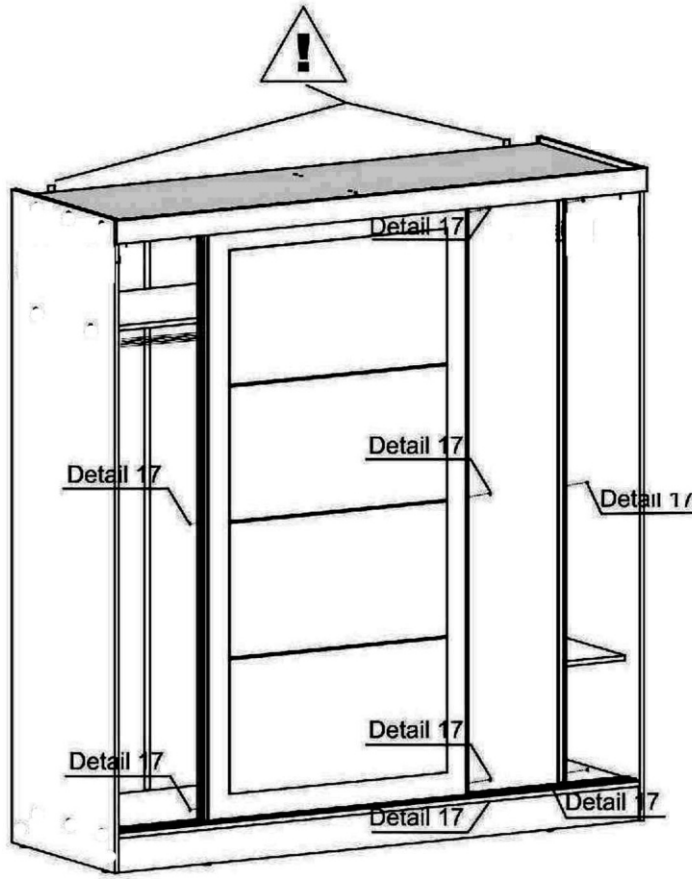

Detail 17

ATTENTION

Doors Adjustment

Illustrative picture

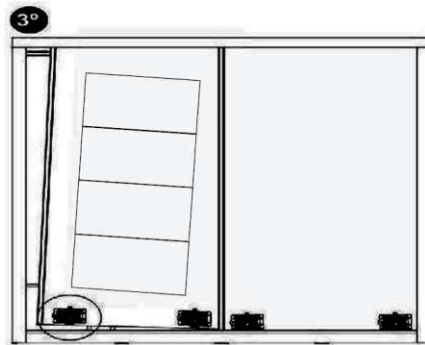
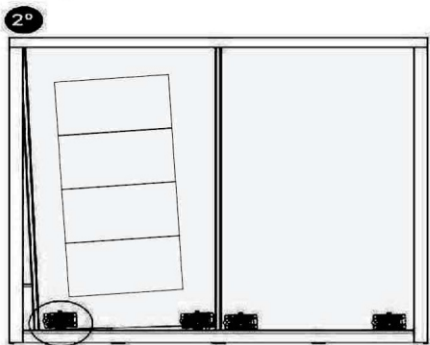
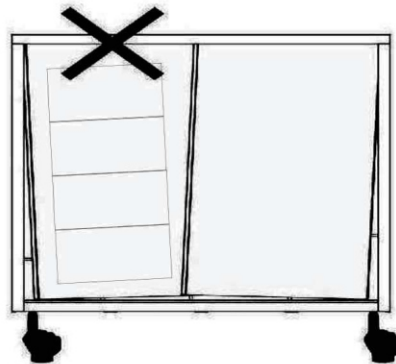
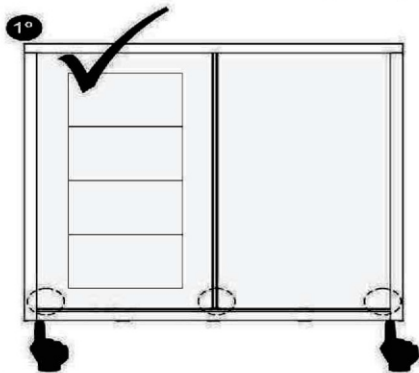

BEFORE REGULATION
UNLOCK THE PULLEY

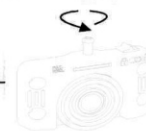

BEFORE REGULATION
UNLOCK THE PULLEY

WARNING

Serious or fatal injuries can occur from furniture tipping over. To prevent the furniture from tipping over we recommend that it is permanently fixed to the wall.

Wall fixings are not supplied with this product as different wall materials require different types of fixing devices.

Please make sure you use fixings suitable for the walls in your home.

