

WHITE GLOSS SEVILLE 2 DOOR WARDROBE ASSEMBLY INSTRUCTIONS

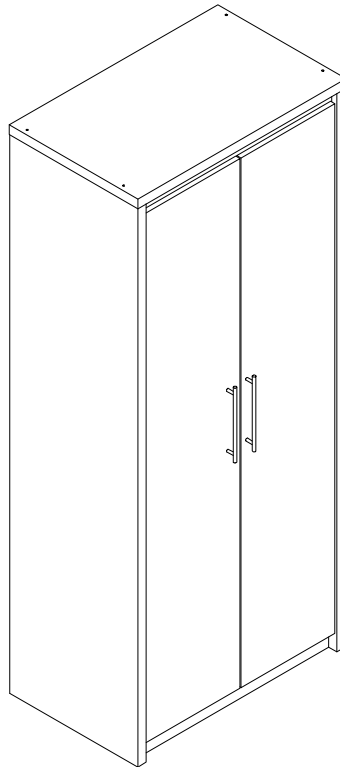

FOR DOMESTIC USE ONLY
IMPORTANT

PLEASE READ BEFORE YOU CONTINUE FURTHER

THE PRODUCT YOU HAVE PURCHASED WILL GIVE YOU MANY YEARS OF SERVICE IF YOU FOLLOW THE GUIDELINES FOR ITS SAFE ASSEMBLY AND PERIODIC MAINTENANCE AND CLEANING.

ASSEMBLE ON A SOFT CLEAN SURFACE.

DO NOT USE ANY TOOLS OTHER THAN THOSE SHOWN.

ANY SPANNERS OR ALLEN KEYS REQUIRED ARE INCLUDED WITH THE FITTING KIT.

DO NOT FOR ANY REASON USE A POWER TOOL TO ASSEMBLE THIS PRODUCT. ITS USE WILL INVALIDATE ANY CLAIM YOU MAY HAVE AND COULD MAKE THIS PRODUCT UNSAFE.

DEPENDING ON THE AMOUNT OF USE THIS PRODUCT RECEIVES, IT MAY BE NECESSARY TO TIGHTEN UP THE FIXINGS FROM TIME TO TIME. THIS IS COMPLETELY NORMAL FOR ANY FLAT PACK FURNITURE. DO NOT OVERTIGHTEN FIXINGS.

FOR CLEANING, YOU MAY USE A DAMP CLOTH (NOT WET). DO NOT USE POLISH, DETERGENT OR CHEMICAL CLEANERS.



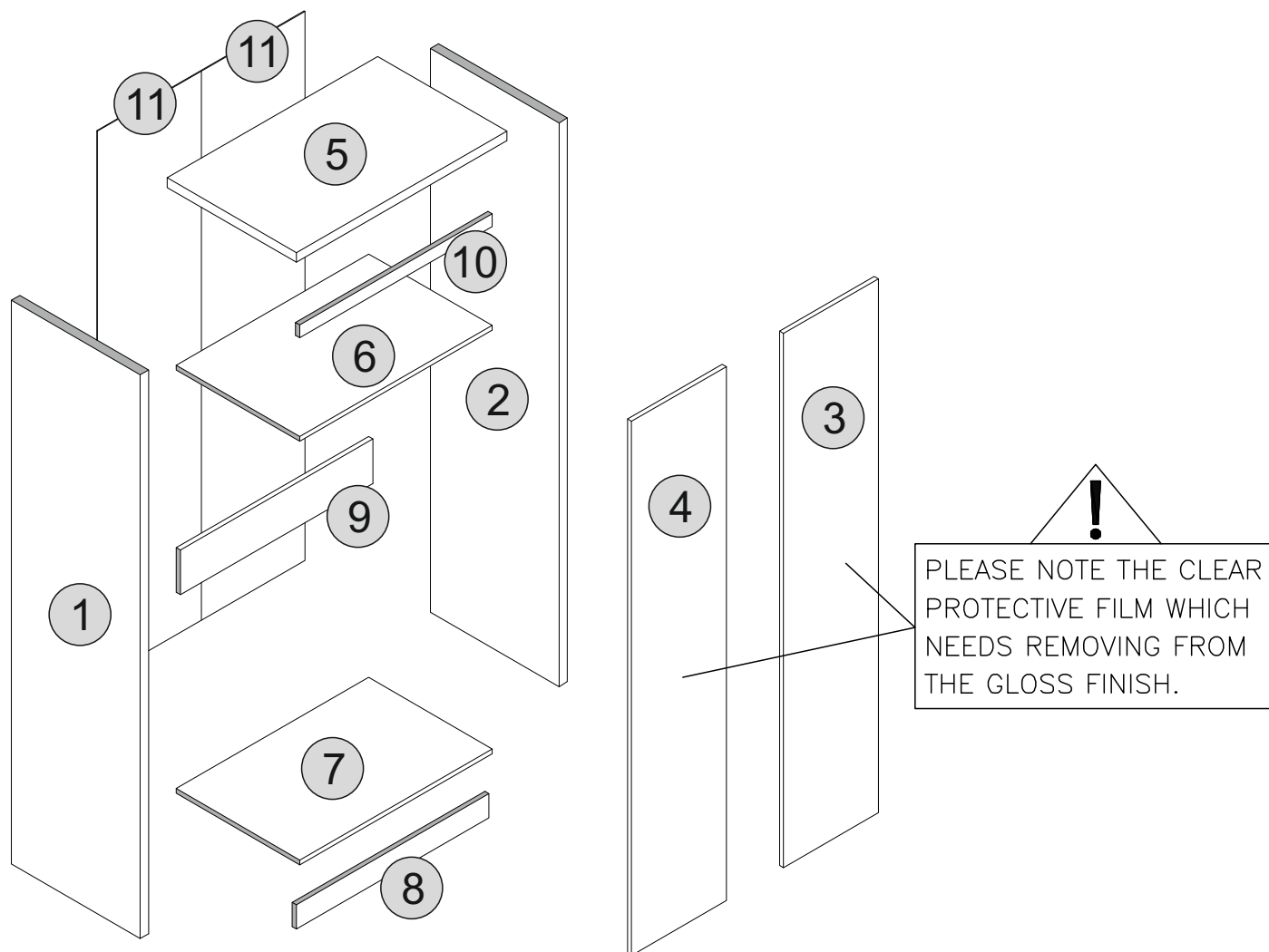









THIS SURFACE OF THIS ITEM IS NOT HEAT RESISTANT. ALWAYS USE A PLACE MAT UNDER HOT OR COLD ITEMS TO PREVENT MARKING.



PART LIST

Part Number	Part Code	Part Description	Quantity	Carton
1	S100-101-045-ZF1-01	Left Side Panel	1	1/2
2	S100-101-045-ZF1-02	Right Side Panel	1	1/2
3	S100-101-045-ZF1-03	Right Door Panel	1	1/2
4	S100-101-045-ZF1-04	Left Door Panel	1	1/2
5	S100-101-045-ZF1-05	Top Panel	1	2/2
6	S100-101-045-ZF1-06	Shelf	1	2/2
7	S100-101-045-ZF1-07	Bottom Panel	1	2/2
8	S100-101-045-ZF1-08	Crossbar	1	2/2
9	S100-101-045-ZF1-09	Back Support	1	2/2
10	S100-101-045-ZF1-10	Support Panel	1	2/2
11	S100-101-045-ZF1-11	Back Panel	2	1/2

HARDWARE LIST

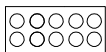
No.	Part Name		Qty
A	Wooden Dowel (6x25mm)		x22
B	65mm Screw (4x65mm)		x14
C	14mm Screw (3.5x14mm)		x38
D	Hanging Rail (689mm)		x1
E	3mm Hinges (M11)		x6
F	Hanging Rail Support		x2
G	10" Handle (192mm)		x2
H	20mm Handle Screw		x4
I	PVC L - Bracket		x2
J	Plastic Foot		x5
K	6/8" Nail		x58
L	Wall Fixings		x1
M	Screw Cover (Sticker 12mm)		x10

TIPS FOR FITTINGS CAM-LOCKS

WHEN FITTING CAM NUT. ENSURE STARTING POSITION IS CORRECT BEFORE YOU INSERT CONNECTING CAM BOLT TURN CLOCKWISE UNTIL SECURE

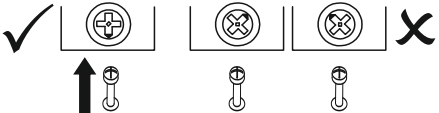

CORRECT **WRONG**

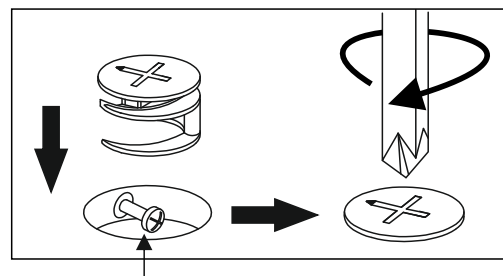

Cam bolt head needs to be in centre

CAMBOLT

Tighten until shoulder in flush with panel. Do not overtighten or undertighten (see example below)

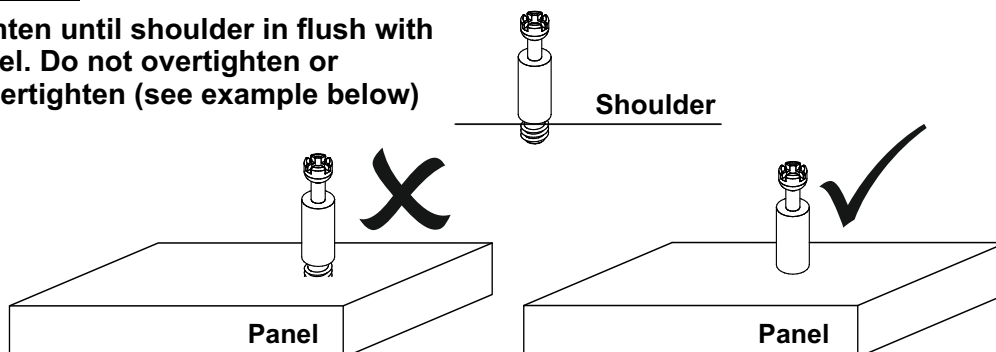





STEP 1

PARTS REQUIRED

1 - LEFT SIDE PANEL x1

HARDWARE REQUIRED

A		02
C		02
F		01
J		02

TOOLS REQUIRED

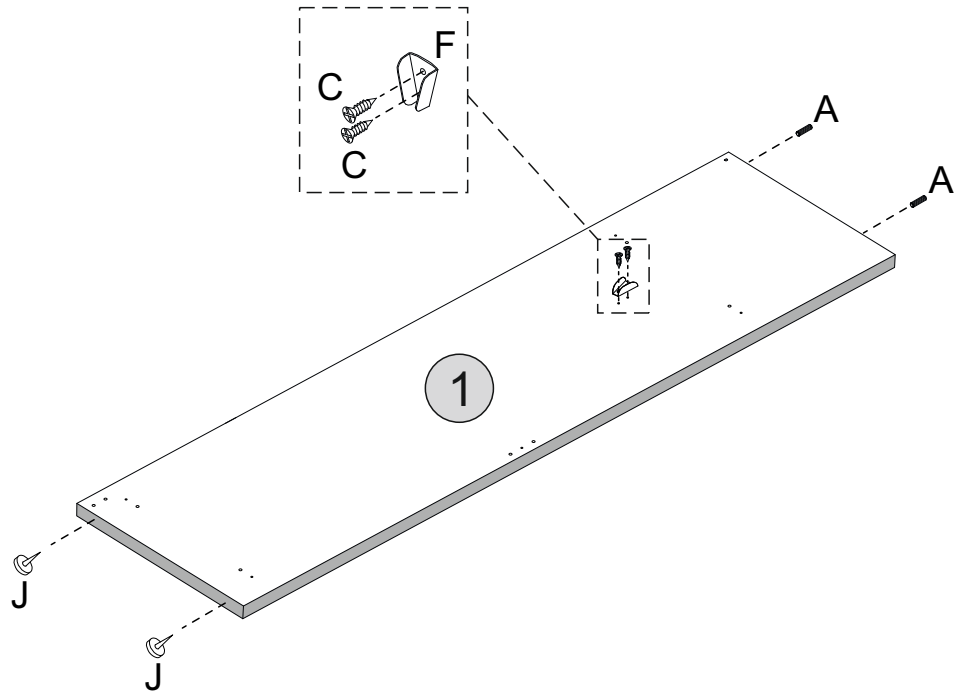
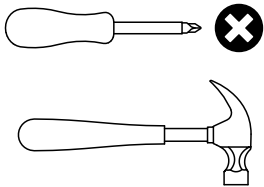





STEP 2

PARTS REQUIRED

2 - RIGHT SIDE PANEL x1

HARDWARE REQUIRED

A		02
C		02
F		01
J		02

TOOLS REQUIRED

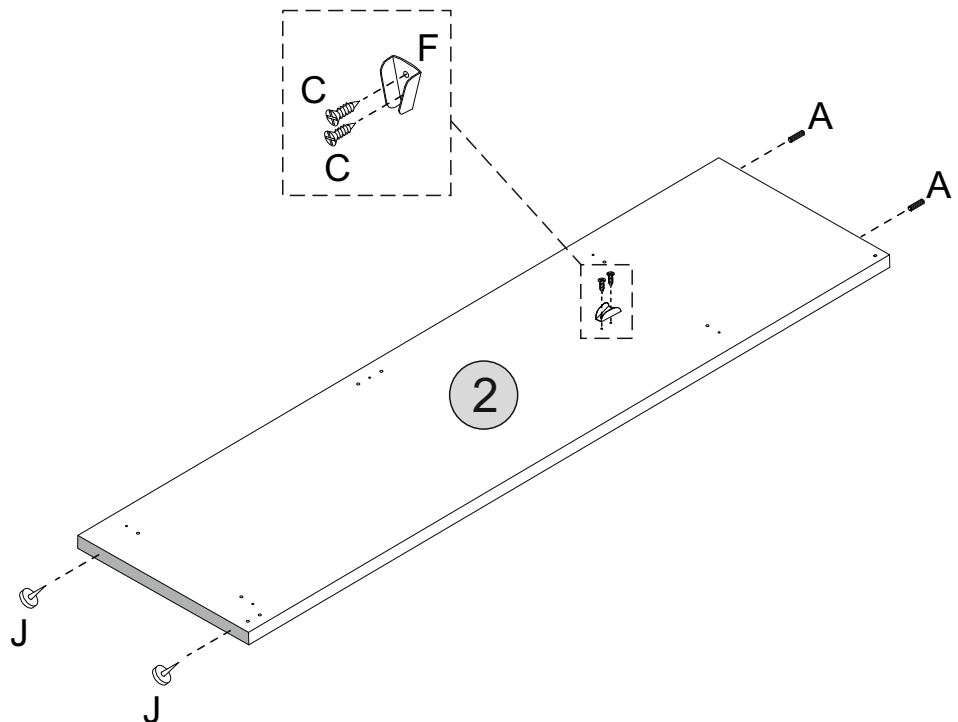
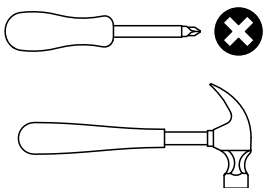

STEP 3

PARTS REQUIRED

6 - SHELF x1

7 - BOTTOM PANEL x1

HARDWARE REQUIRED

A  08

TOOLS REQUIRED

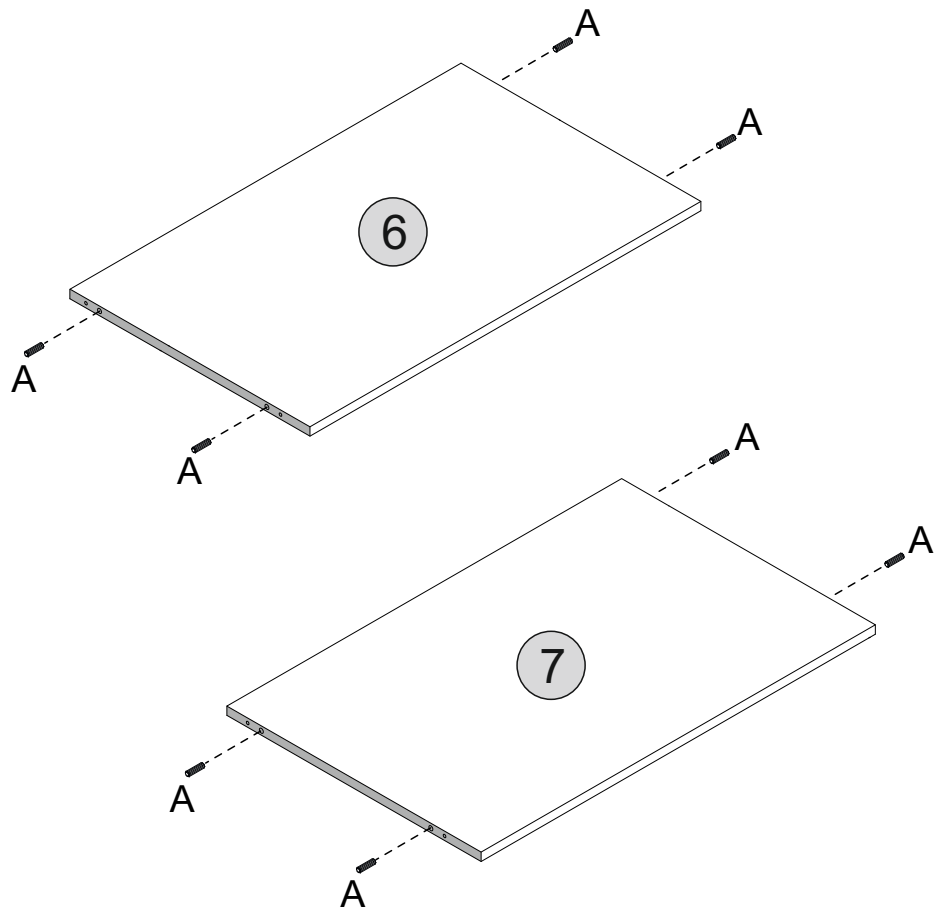

STEP 4

PARTS REQUIRED

8 - CROSSBAR x1

9 - BACK SUPPORT x1

10 - SUPPORT PANEL x1

HARDWARE REQUIRED

A  10

J  01

TOOLS REQUIRED

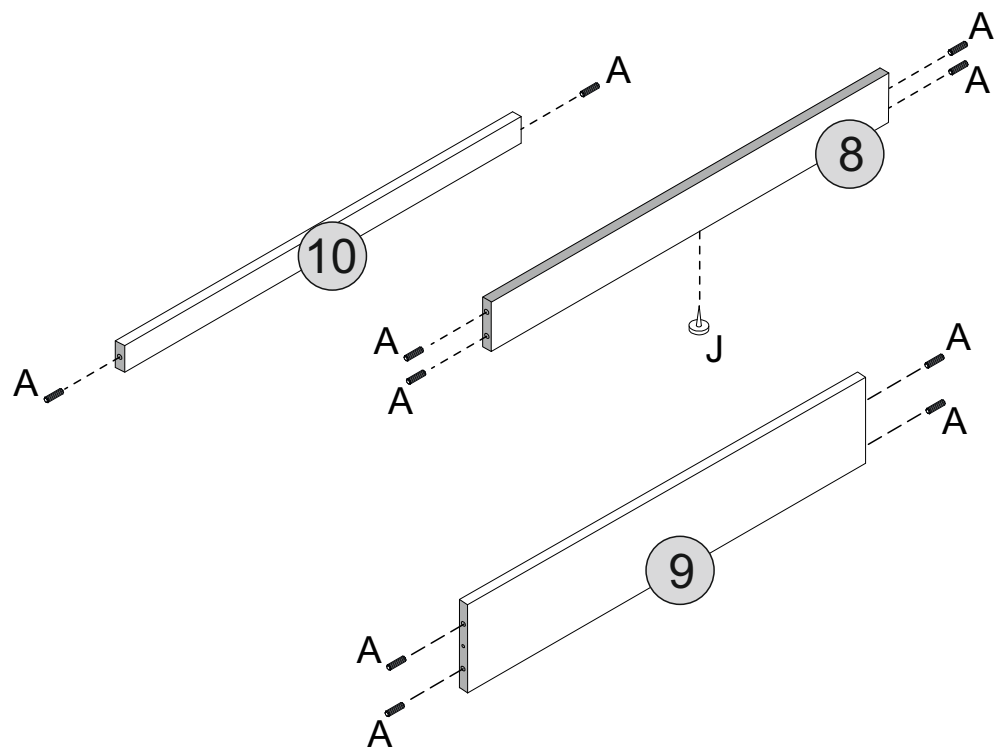
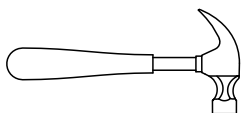



STEP 5

PARTS REQUIRED

1 - LEFT SIDE PANEL	x1
6 - SHELF	x1
7 - BOTTOM PANEL	x1
9 - BACK SUPPORT	x1

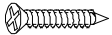
HARDWARE REQUIRED

B		05
M		05

TOOLS REQUIRED

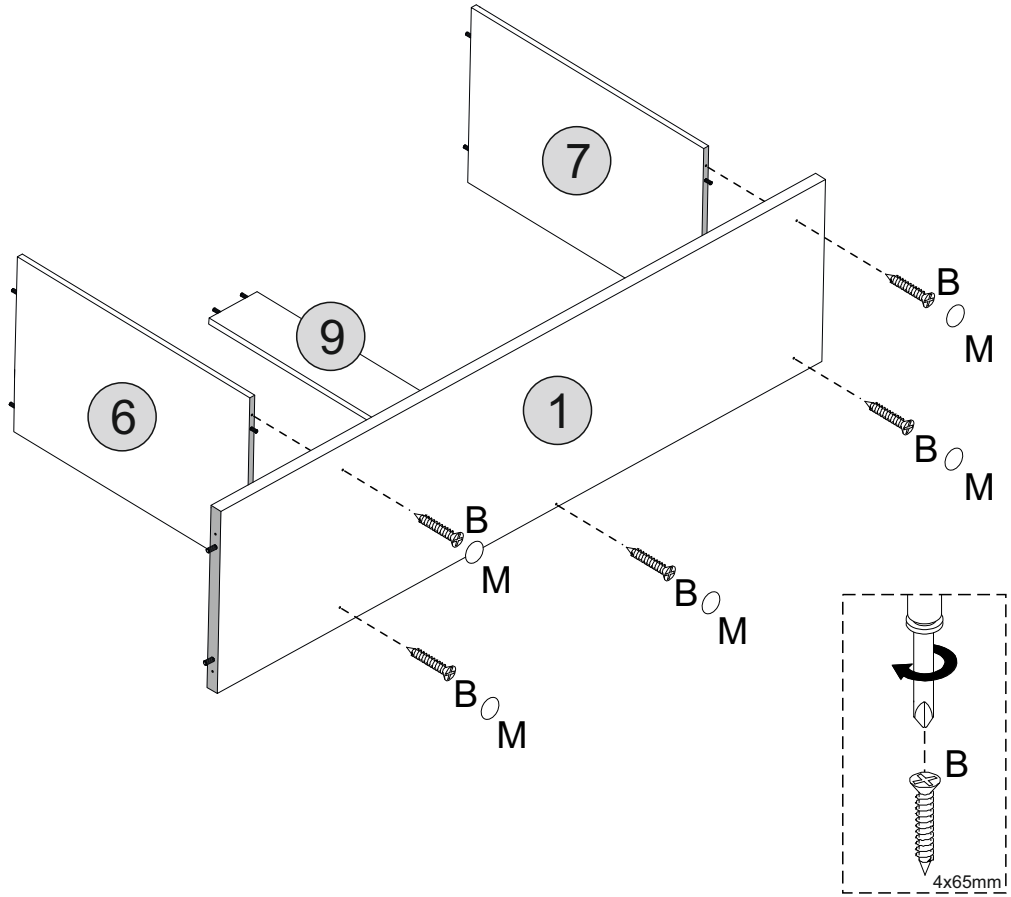
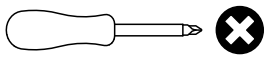



STEP 6

PARTS REQUIRED

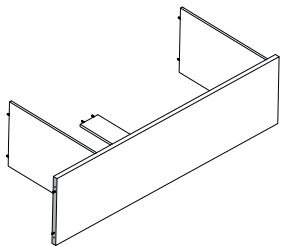
2 - RIGHT SIDE PANEL	x1
8 - CROSSBAR	x1
10 - SUPPORT PANEL	x1



HARDWARE REQUIRED

B		05
M		05

TOOLS REQUIRED

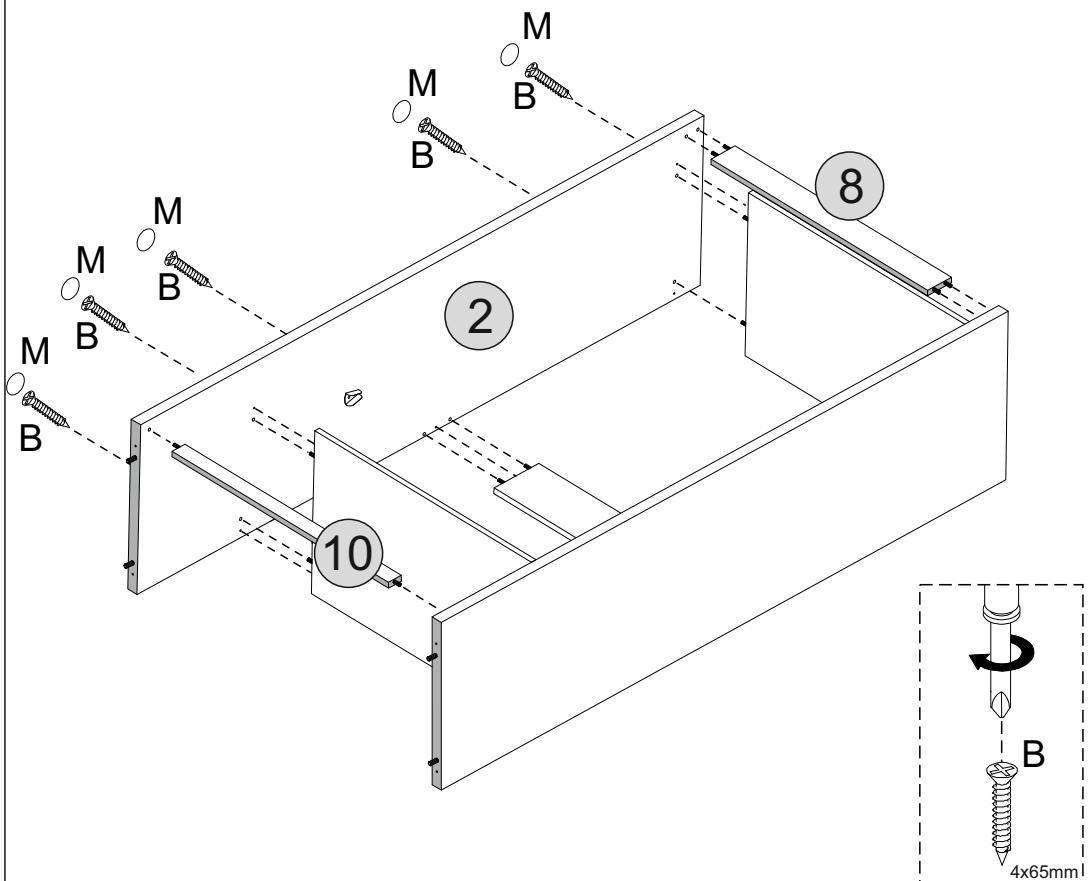
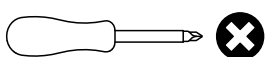

STEP 7

PARTS REQUIRED

5 - TOP PANEL x1

HARDWARE REQUIRED

C  02

I  01

TOOLS REQUIRED

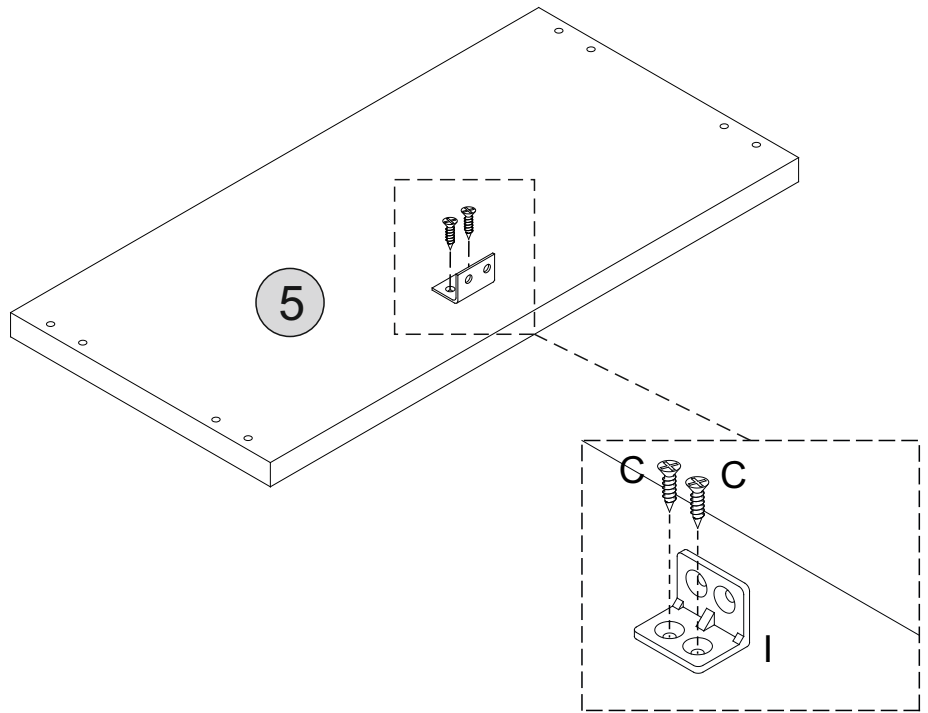
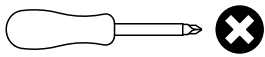

STEP 8

PARTS REQUIRED

5 - TOP PANEL x1

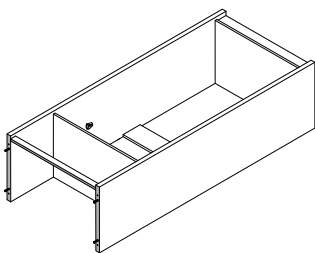

HARDWARE REQUIRED

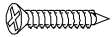
B  04

C  06

I  01

TOOLS REQUIRED

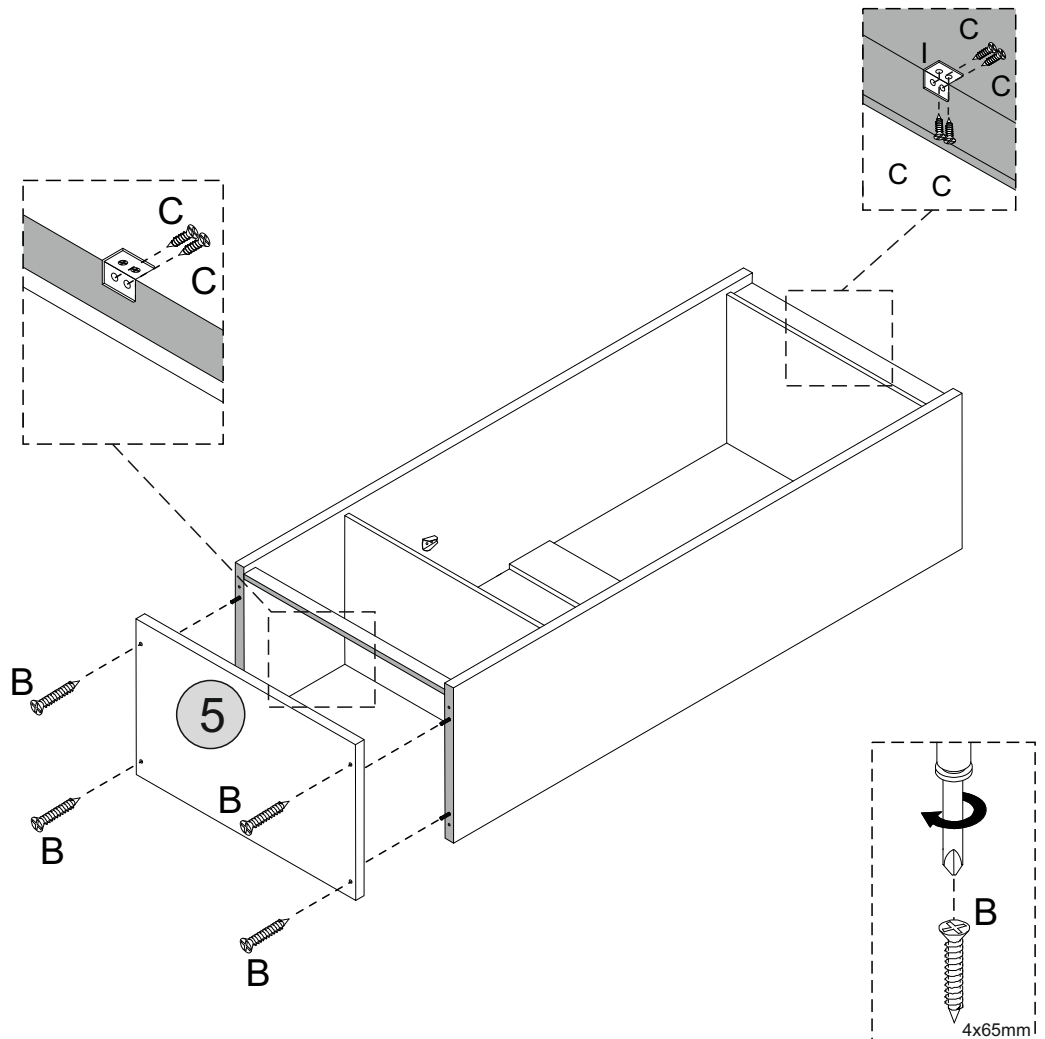
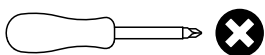

STEP 9

PARTS REQUIRED

11 - BACK PANEL x2

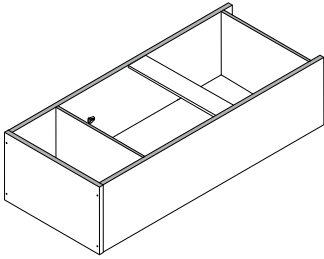

HARDWARE REQUIRED

C  02

K  58

TOOLS REQUIRED

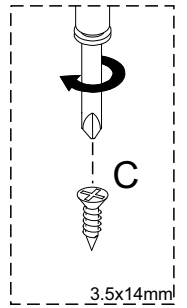
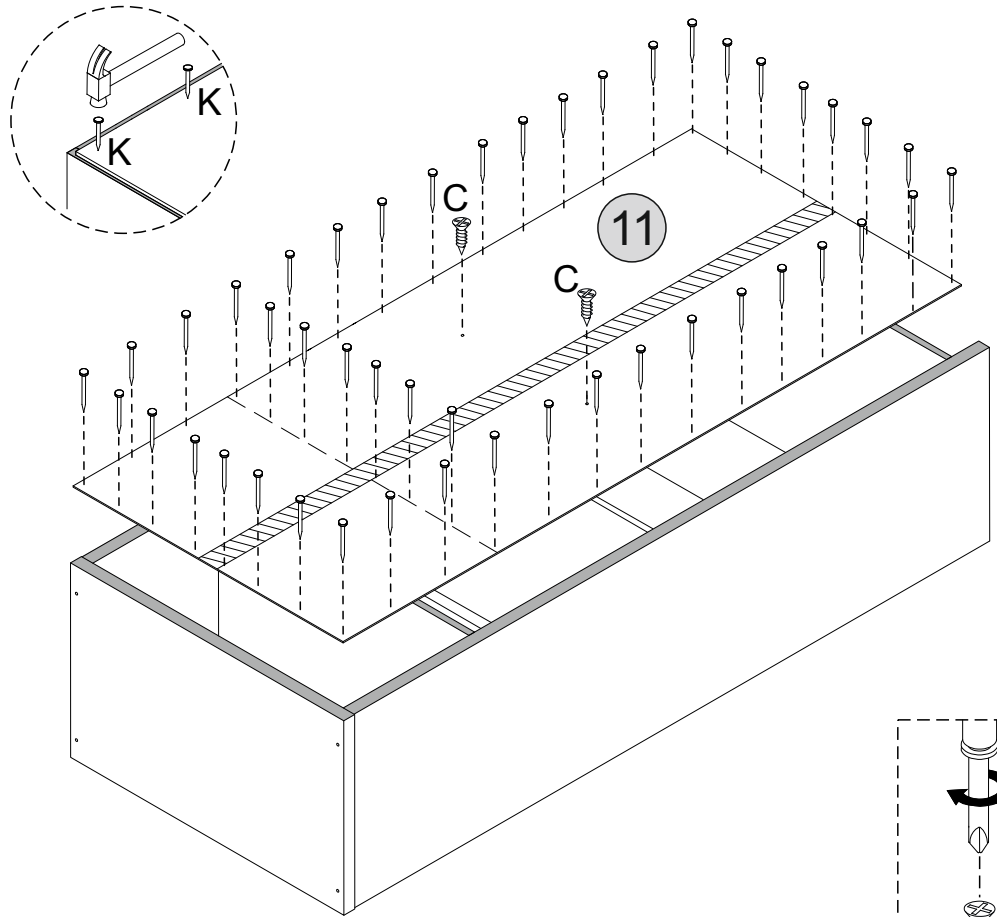
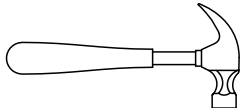
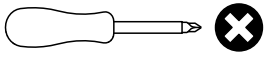

STEP 10

PARTS REQUIRED

3 - RIGHT DOOR PANEL x1

4 - LEFT DOOR PANEL x1

HARDWARE REQUIRED

C  12

E  06

TOOLS REQUIRED

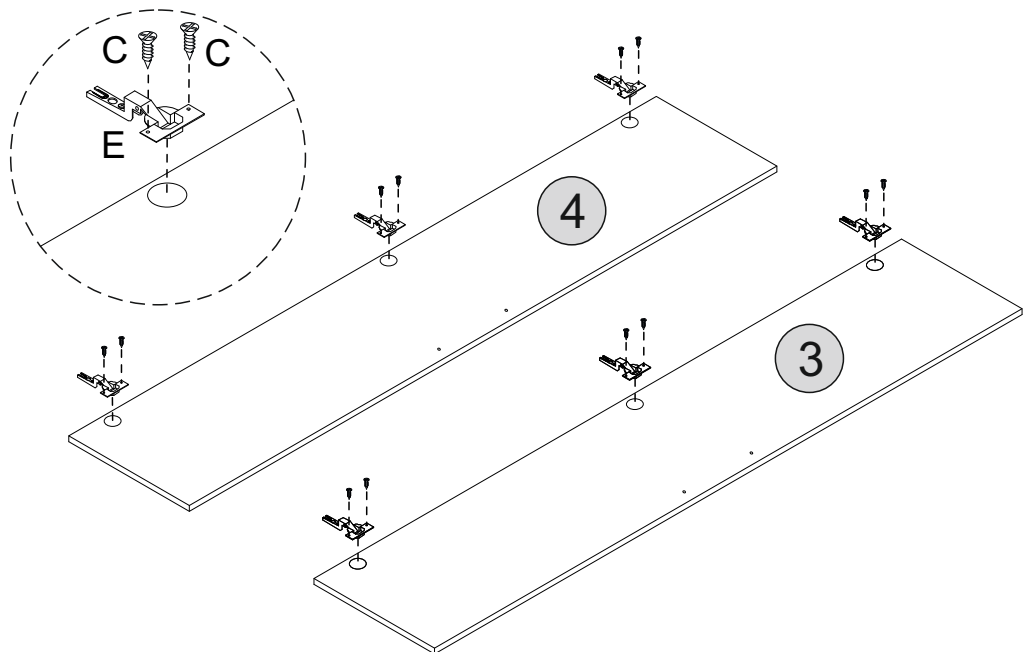
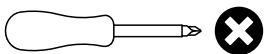

STEP 11

PARTS REQUIRED

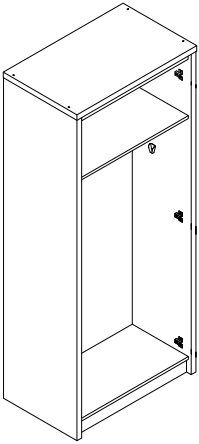

HARDWARE REQUIRED

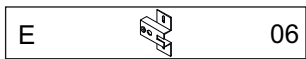
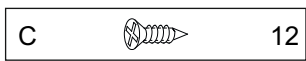

TOOLS REQUIRED

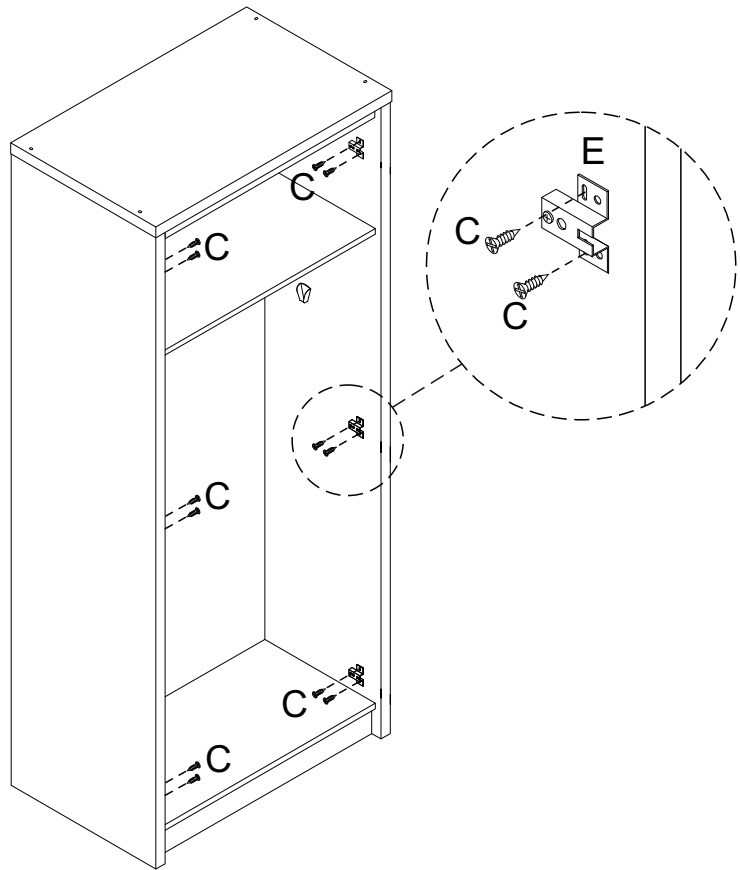
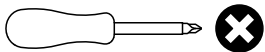

STEP 12

PARTS REQUIRED

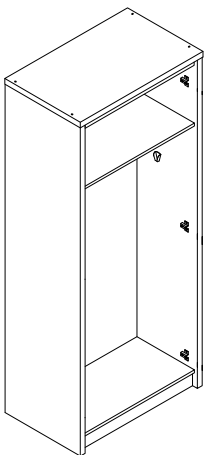
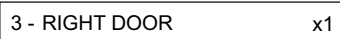

HARDWARE REQUIRED

TOOLS REQUIRED

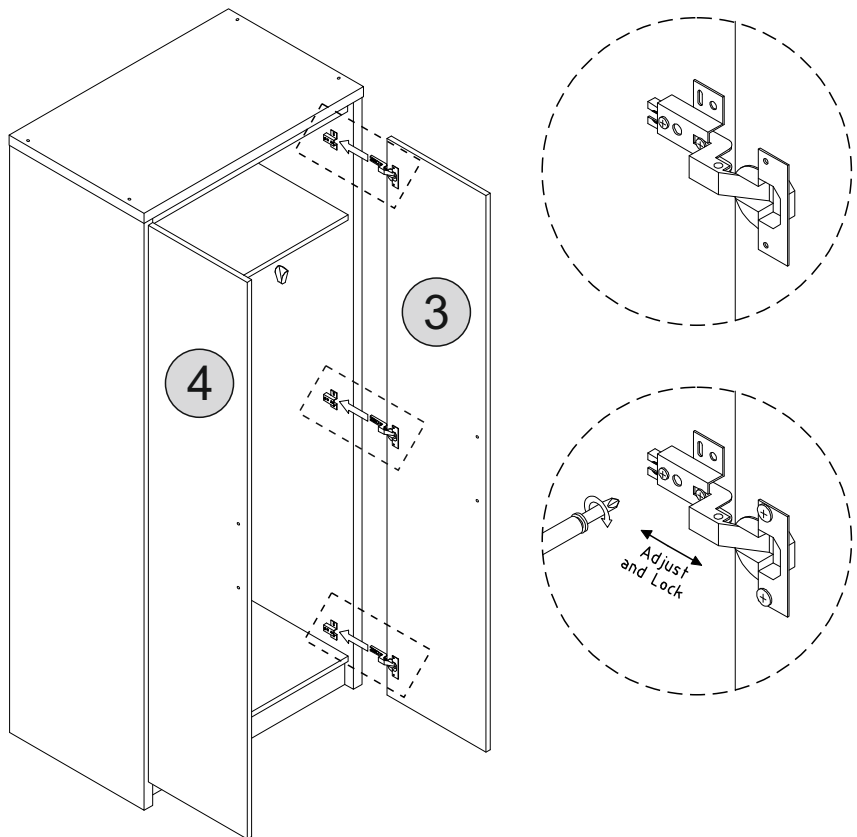
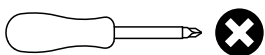

STEP 13

PARTS REQUIRED

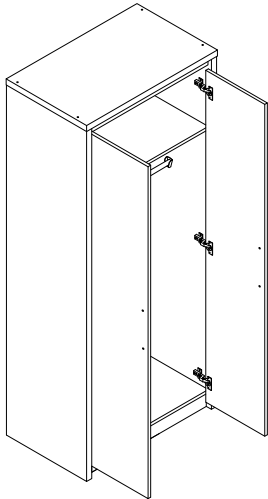

HARDWARE REQUIRED

D		01
G		02
H		04

TOOLS REQUIRED

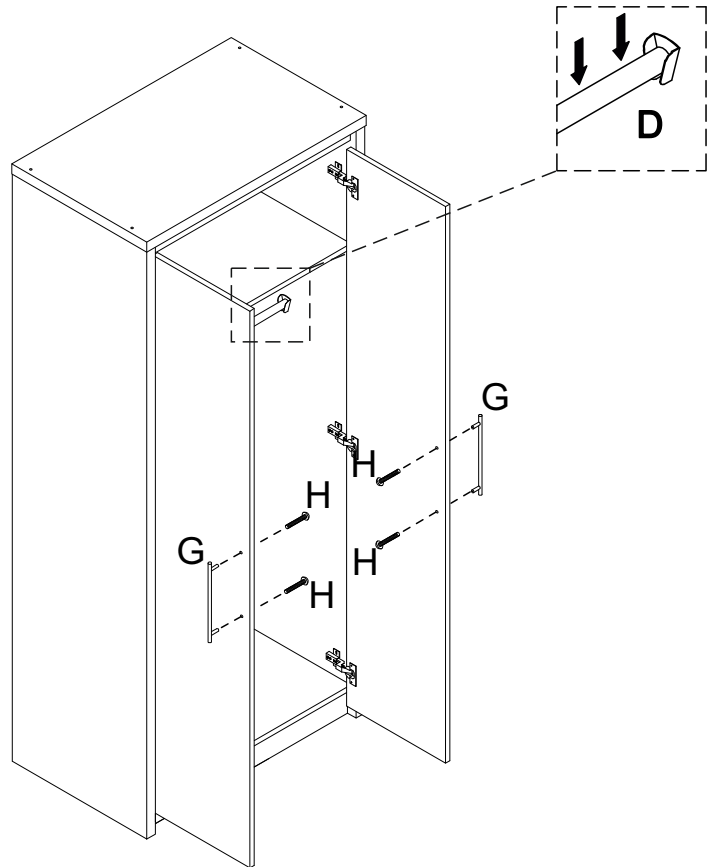
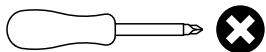

STEP 14

PARTS REQUIRED

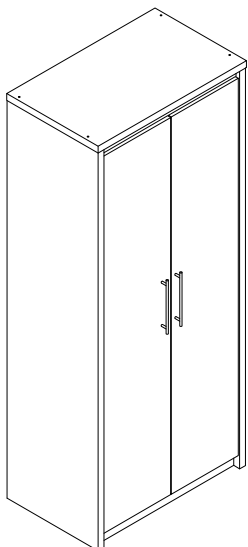

HARDWARE REQUIRED

H		01
---	--	----

TOOLS REQUIRED

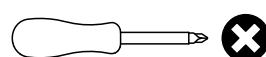

WARNING

Serious or fatal injuries can occur from furniture tipping over. To prevent the furniture from tipping over we recommend that it is permanently fixed to the wall.

Wall fixings are not supplied with this product as different wall materials require different types of fixing devices. Please make sure you use fixings suitable for the walls in your home.

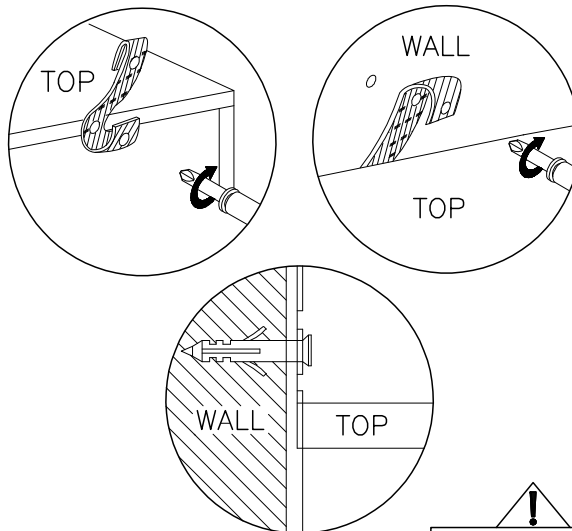

!
PLEASE NOTE THE CLEAR PROTECTIVE FILM WHICH NEEDS REMOVING FROM THE GLOSS FINISH.

