

NEVADA 3 DOOR SLIDER WARDROBE ASSEMBLY INSTRUCTIONS

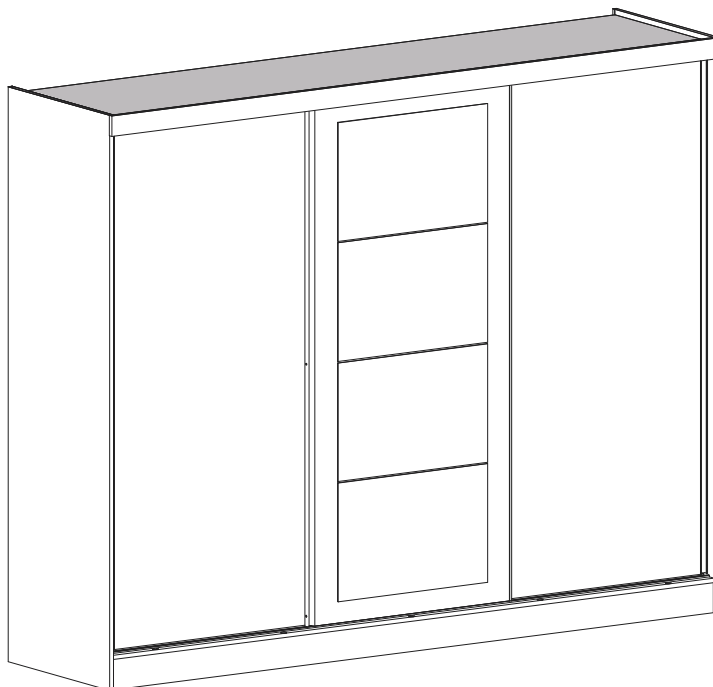
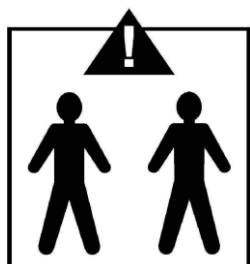

IMPORTANT FOR DOMESTIC USE ONLY

PLEASE READ BEFORE YOU CONTINUE FURTHER

CARE AND MAINTENANCE

- After unpacking this product please keep the original packaging in case it needs to be returned for any reason.
- Please ensure all fittings and parts are present before commencing with assembly.
 - Never drag or push products as this could cause damage to the joints making it inferior.
 - We strongly recommend that you keep children away from your work area.
 - We recommend that you lay a blanket or sheet on the floor to avoid damage to both your floor and the product.
 - Assemble this product as close to its final position as possible.
 - Do not place this product next to a radiator or in direct sunlight.
 - Do not drag or push items across your high gloss furniture as this may cause the surface to scratch
 - Wood is a natural product and may expand if subjected to damp and may shrink or crack if subjected to heat. Therefore it is recommended that room temperature is maintained, with no sudden temperature fluctuations.
 - Make sure any spillage is wiped off immediately.
 - Do not place hot or chilled items directly on to the surface, use a place mat or marking will occur.
 - For general cleaning use a soft cotton or micro fibre cloth, and do not use detergents of any kind.
 - From time to time it may be necessary to tighten fittings, regular inspections should be carried out.
 - Do not place on a wet or damp floor as staining may occur to your floor.

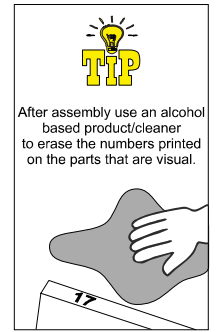
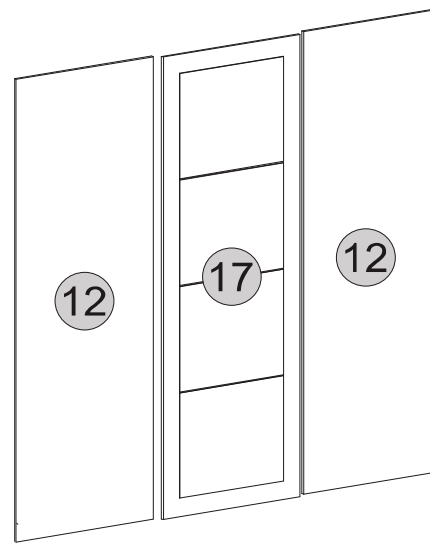
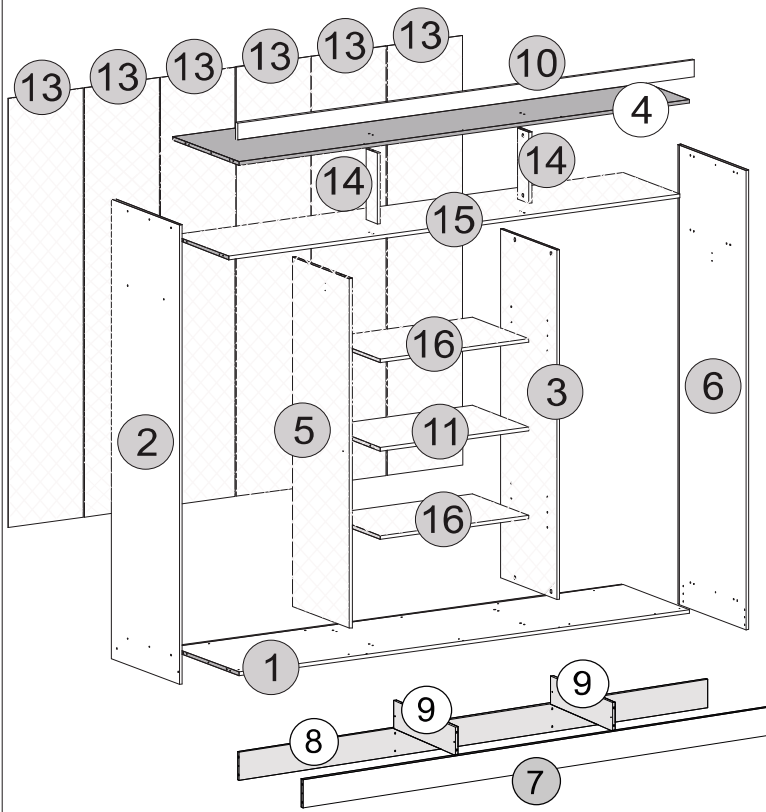

TOOLS REQUIRED

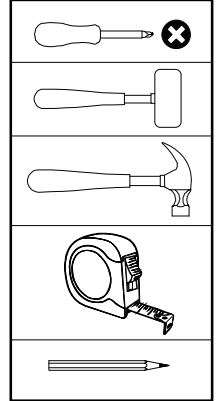



















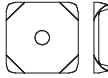
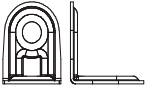





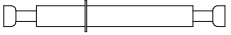

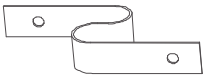
PARTS LIST

Please Note:

The below parts have all been stamped with the part number to help identify them during assembly.

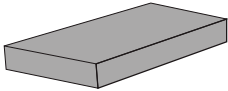
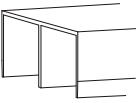
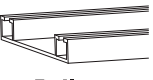
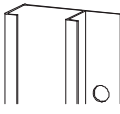
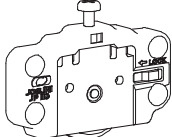
Part Number	Part Description	Quantity	Carton
1	Base Panel	1	1/4
2	Left Side	1	2/4
3	Right Division Panel	1	3/4
4	Top Panel	1	1/4
5	Left Division Panel	1	3/4
6	Right Side	1	2/4
7	Front Baseboard	1	1/4
8	Back Baseboard	1	1/4
9	Crossbeam	2	1/4
10	Frame	1	1/4
11	Fixed Shelf	1	1/4
12	Door	2	4/4
13	Back Panel	6	2/4
14	Small Divider Panel	2	1/4
15	Large Shelf Panel	1	3/4
16	Movable Shelf	2	3/4
17	Mirrored Door	1	4/4

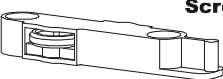
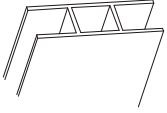
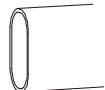
FITTINGS LIST

A x 8  Cam Bolt 32xØ6mm 1/+	B x 12  Can Nut Ø15 mm 2/+	C x 34  Screw Ø4 x 14 mm 2/+	D x 8  Shelf Support 7x6 1/+	E x 34  Dowel Ø6 x 30 mm 2/+
F x 24  Screw Ø4 x 50 mm 2/+	G x 6  Dowel Ø6 x 70 mm 1/+	H x 68  Nail 10x10 Ringed - 1,5x23mm 2/+	I x 14  Back Panel Bracket 14x14 mm 2/+	J x 13  18x18 Corner 2/+
K x 4  Washer Ø16x7 mm 1/+	L x 12  Plastic Foot L 19x17x8mm Ø2mm 2/+	M x 4  Hanging Rail Support	N x 2  Screw Ø3,5 x 30 mm 1/+	O x 32  Screw Ø3.5 x 14 mm 2/+
P x 32  Screw Ø3 x 16 mm 2/+	Q x 2  Cam Bolt (Double) (2x)	R x 10  Screw Ø3.5 x 35 mm 2/+	S x 2  Strap 200x20x1mm	T x 32  Triangle Support Angle 2/+
U x 46  Hole Plugs 19mm 2/+	V x 2  Glue 10g	W x 18  Silicone Drop Ø6x2mm 2/+	X x 2  Dowel Ø6 x 40 mm 1/+	Y x 1  MDF Spacer 80x27x3mm
Z x 1  Top Rail 2398x60x23mm cart. 1/4	A1 x 1  Lower Rail 2398x42x5mm cart. 1/4	B1 x 3  Handle Profile 1760x38x16mm cart. 2/4	F1 SLIDING SYSTEM KIT x 3  Lower Roller Latch x6  Sliding System Lock x4  Screw Ø3.5 x 16 mm x40 (2+)  Upper Roller Latch x6	
C1 x 3  Back Panel Strip 1787x19x6mm cart. 2/4	D1 x 2  Hanging Rail 780x28x16mm cart. 1/4	E1 x 2  Back Panel Strip 297x19x6mm cart. 2/4		
G1 x 16  Hole Plugs Lineo 19mm 2/+				

TIPS FOR FITTINGS CAM-LOCKS

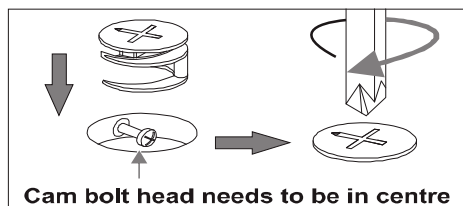
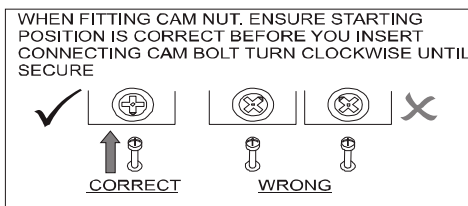

CAMBOLT
 Tighten until shoulder in flush with panel. Do not overtighten or undertighten (see example beside)

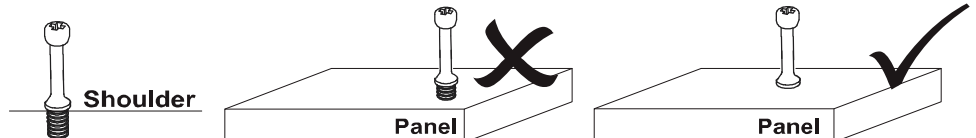





STEP 1

PARTS REQUIRED

7 - FRONT BASEBOARD	x1
8- BACK BASEBOARD	x1
9- CROSSBEAM	x2

HARDWARE REQUIRED

C		04
H		08
J		04
L		08

TOOLS REQUIRED

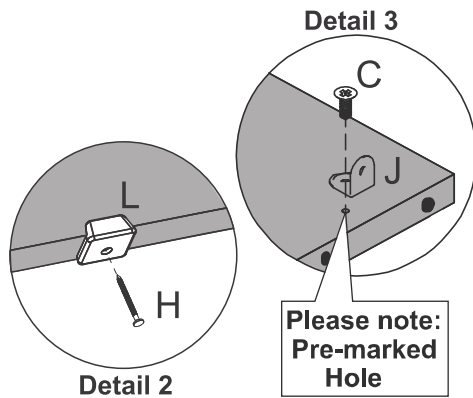
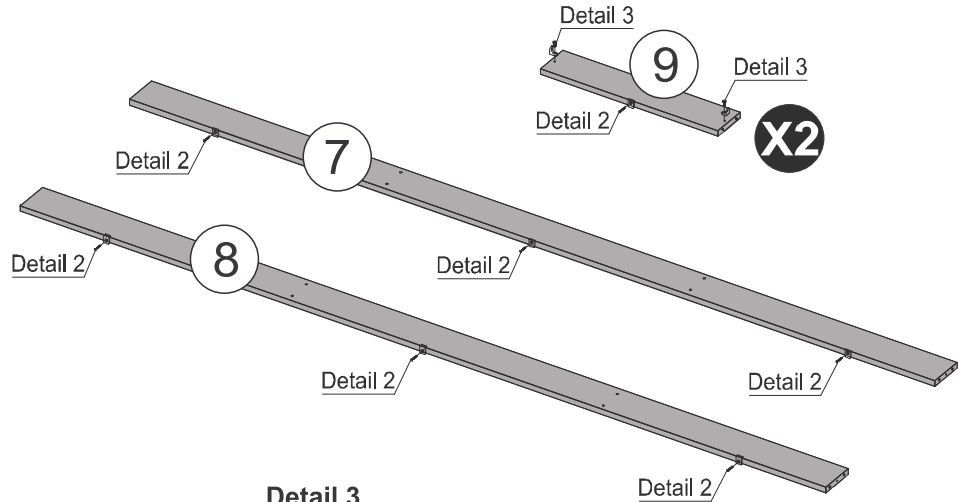
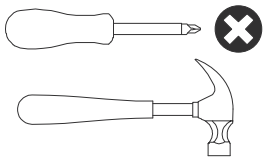



STEP 2

PARTS REQUIRED

7 - FRONT BASEBOARD	x1
8- BACK BASEBOARD	x1
9- CROSSBEAM	x2

HARDWARE REQUIRED

E		16
G		04
V		01

TOOLS REQUIRED

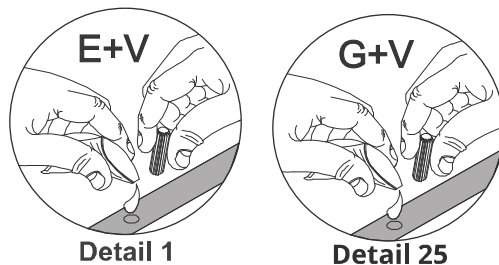
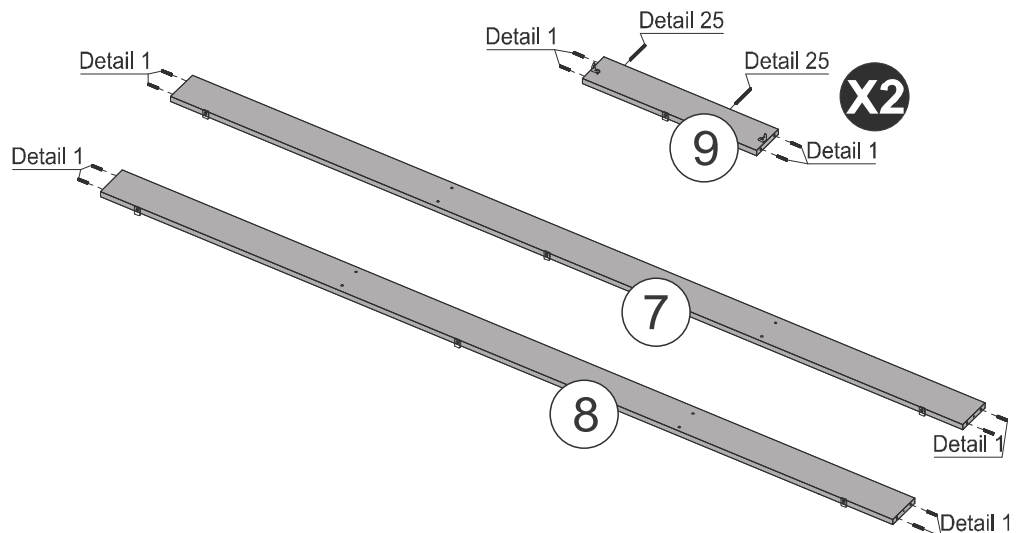
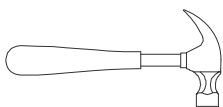





STEP 3

PARTS REQUIRED

1- BASE PANEL	x1
10- FRAME	x1

HARDWARE REQUIRED

C		02
E		04
J		02
V		01

TOOLS REQUIRED

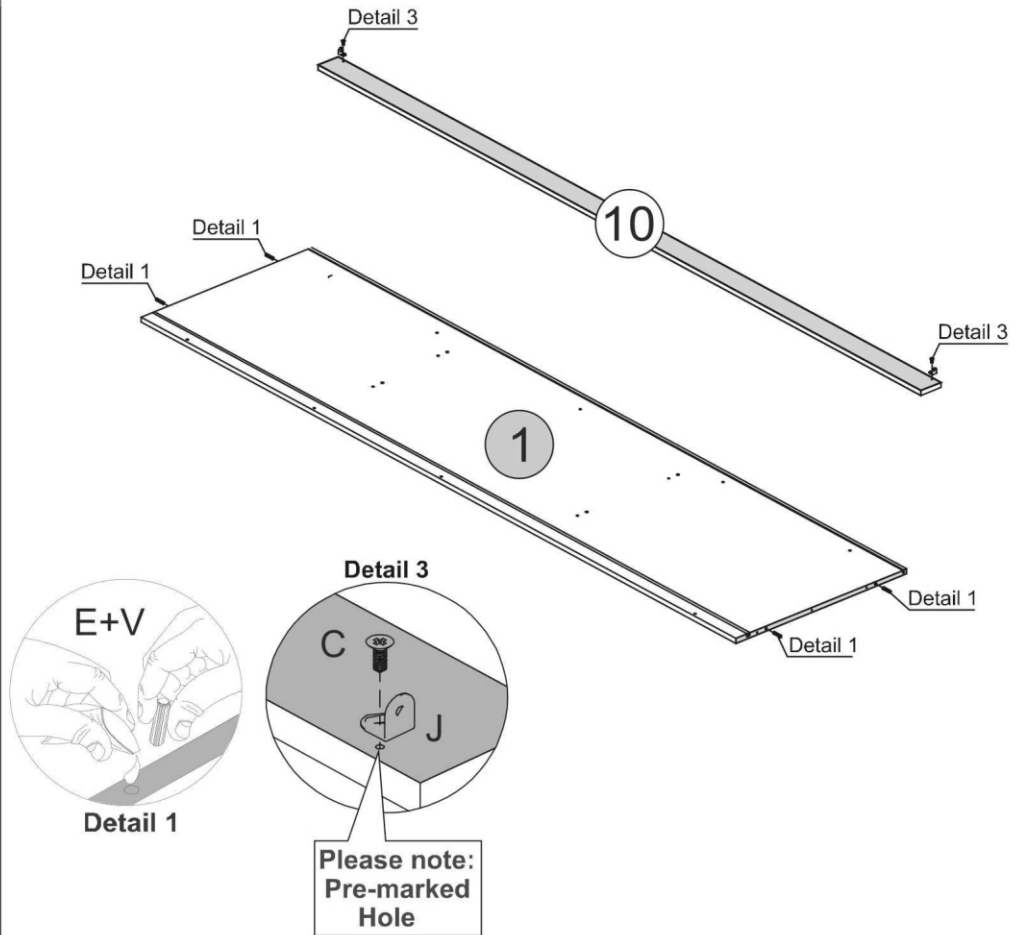
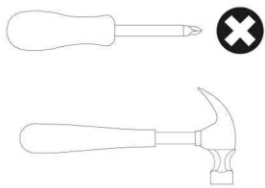



STEP 4

PARTS REQUIRED

1- BASE PANEL	x1
---------------	----

HARDWARE REQUIRED

A		04
A1		01
O		05

TOOLS REQUIRED

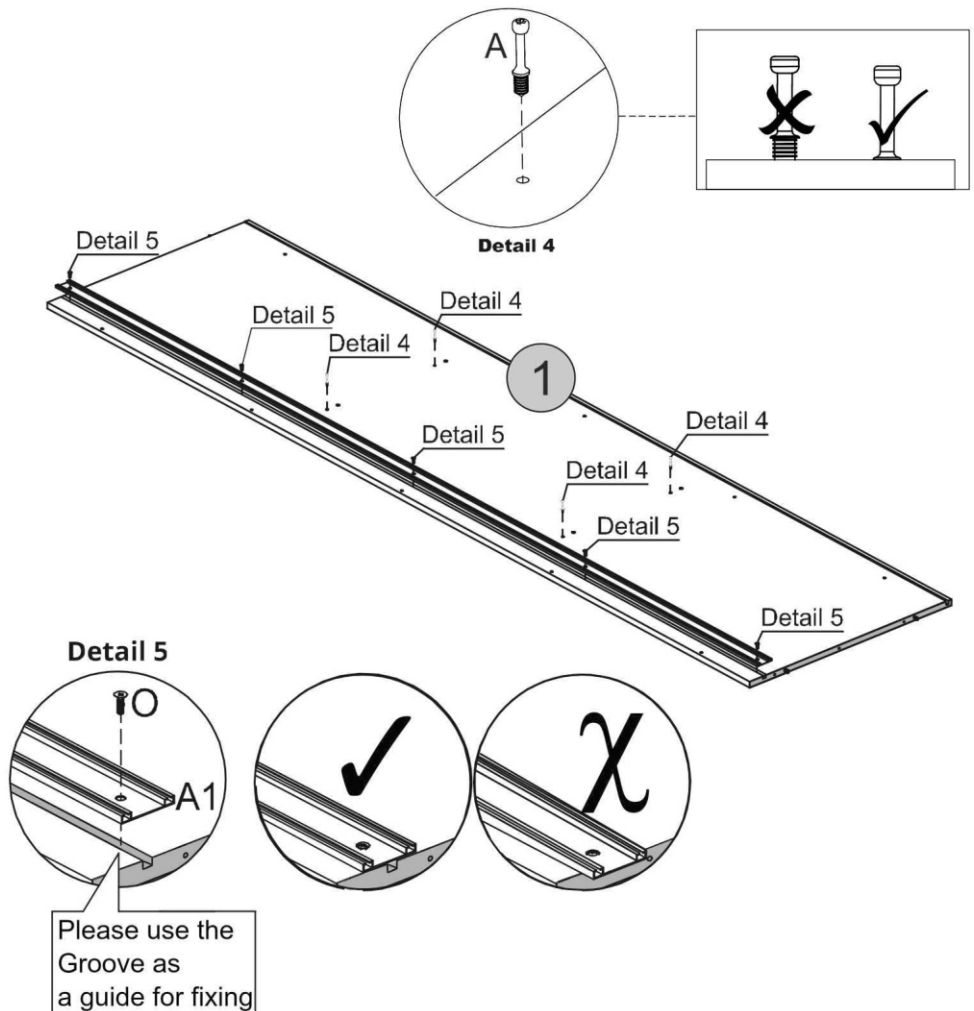

STEP 5

PARTS REQUIRED

11 - FIXED SHELF x1

14 - SMALL DIVIDER PANEL x2

HARDWARE REQUIRED

E  06

G  02

V  01

TOOLS REQUIRED

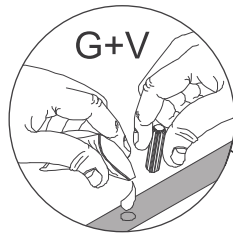
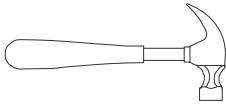

Detail 25

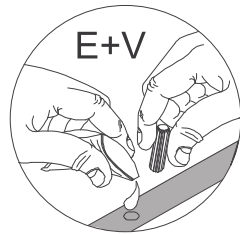
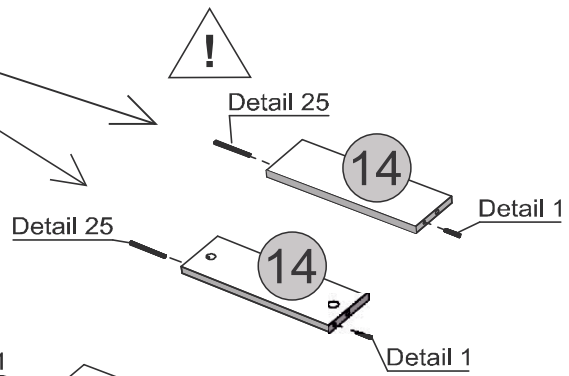

Detail 1

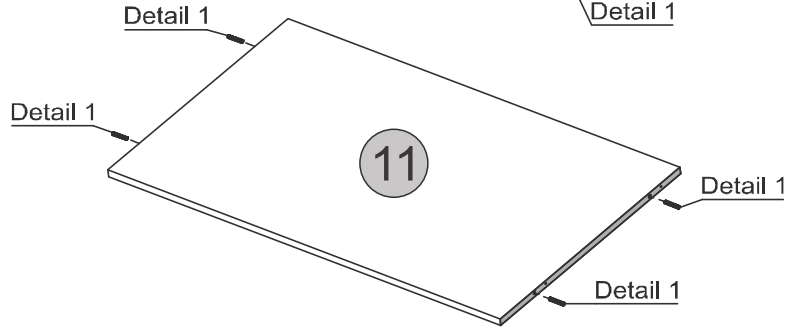

STEP 6

PARTS REQUIRED

2 - LEFT SIDE x1

HARDWARE REQUIRED

C  02

H  02

L  02

M  01

TOOLS REQUIRED

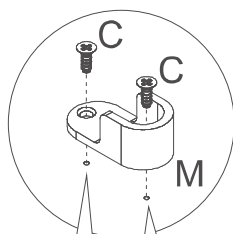
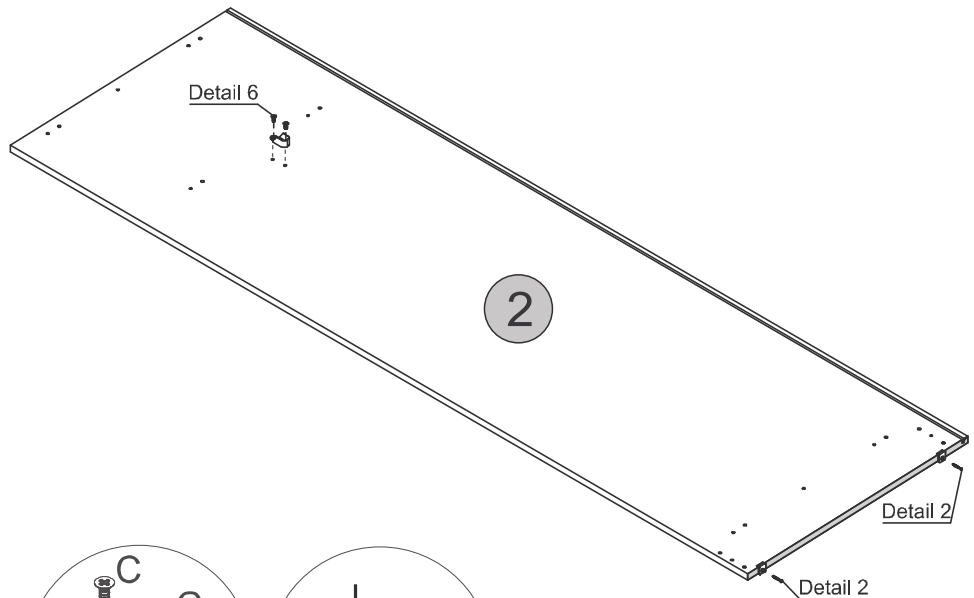
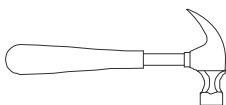

Please note:
Pre-marked
Holes

Detail 6

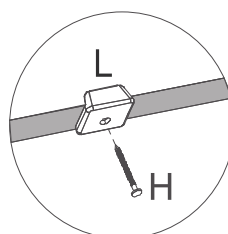





Detail 2

STEP 7

PARTS REQUIRED

6- RIGHT SIDE x1

HARDWARE REQUIRED

C		02
H		02
L		02
M		01

TOOLS REQUIRED

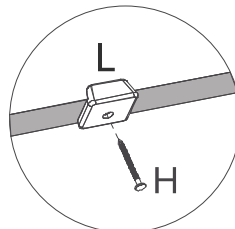
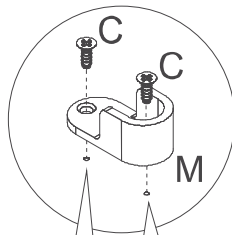
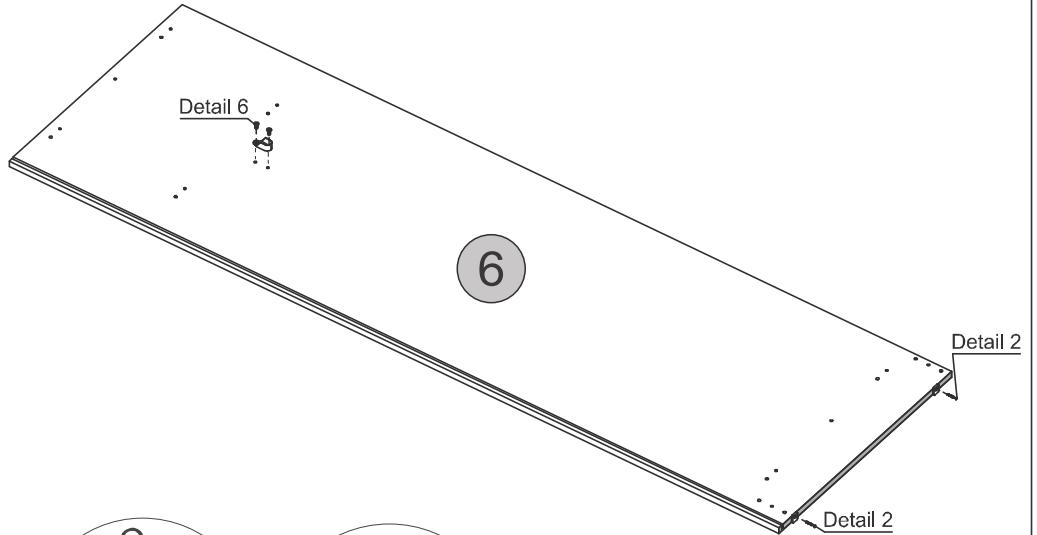
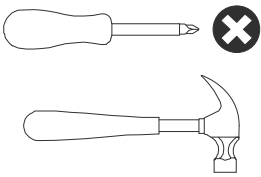

**Please note:
Pre-marked
Holes**
Detail 6





Detail 2

STEP 8

PARTS REQUIRED

3 - RIGHT DIVISION PANEL x1

HARDWARE REQUIRED

C		02
M		01
V		01
X		01

TOOLS REQUIRED

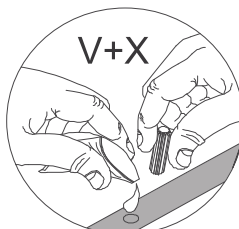
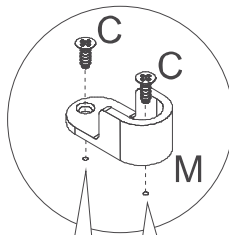
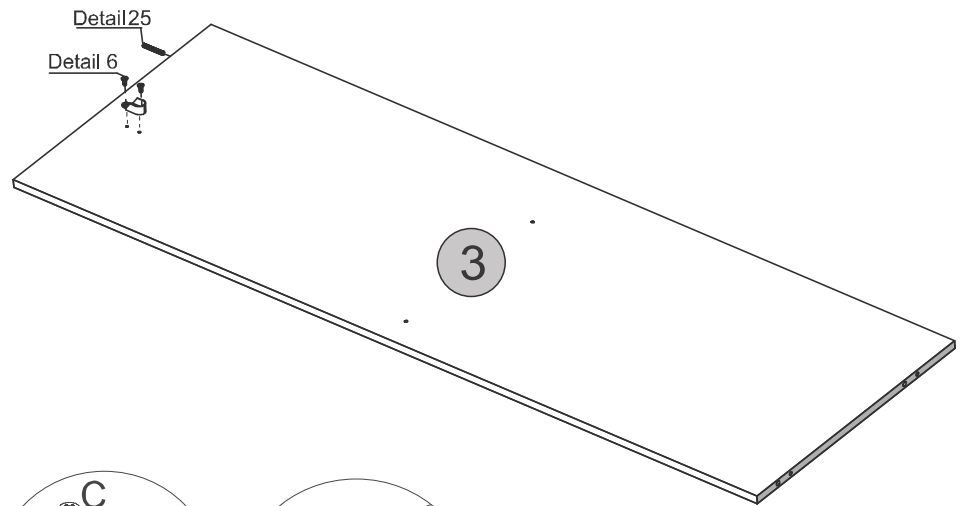
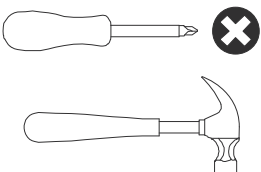

**Please note:
Pre-marked
Holes**
Detail 6

Detail 25

STEP 9

PARTS REQUIRED

3- RIGHT DIVISION PANEL x1

HARDWARE REQUIRED

D  04

TOOLS REQUIRED

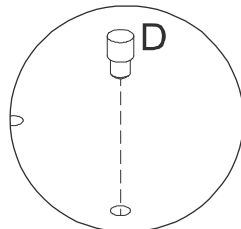
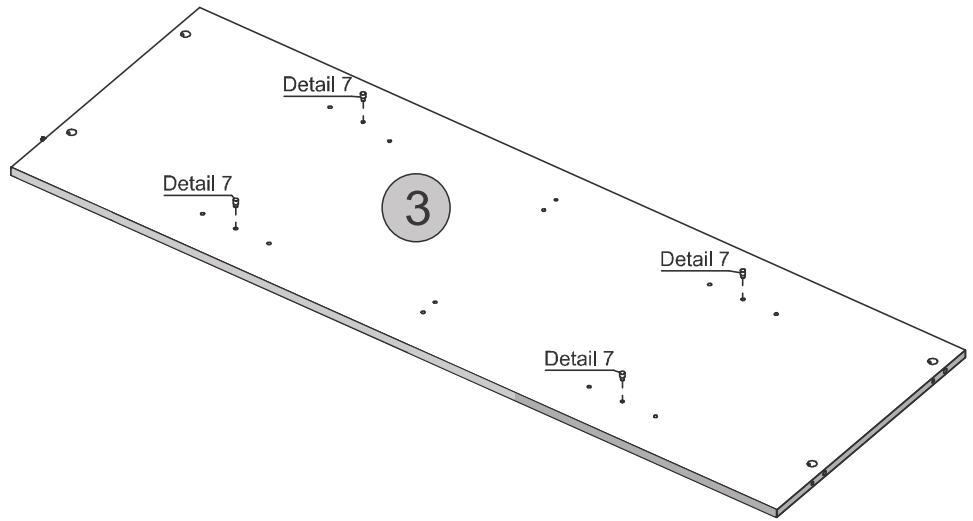
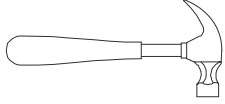

Detail 7

STEP 10

PARTS REQUIRED

5- LEFT DIVISION PANEL x1

HARDWARE REQUIRED

C  02

M  01

V  01

X  01

TOOLS REQUIRED

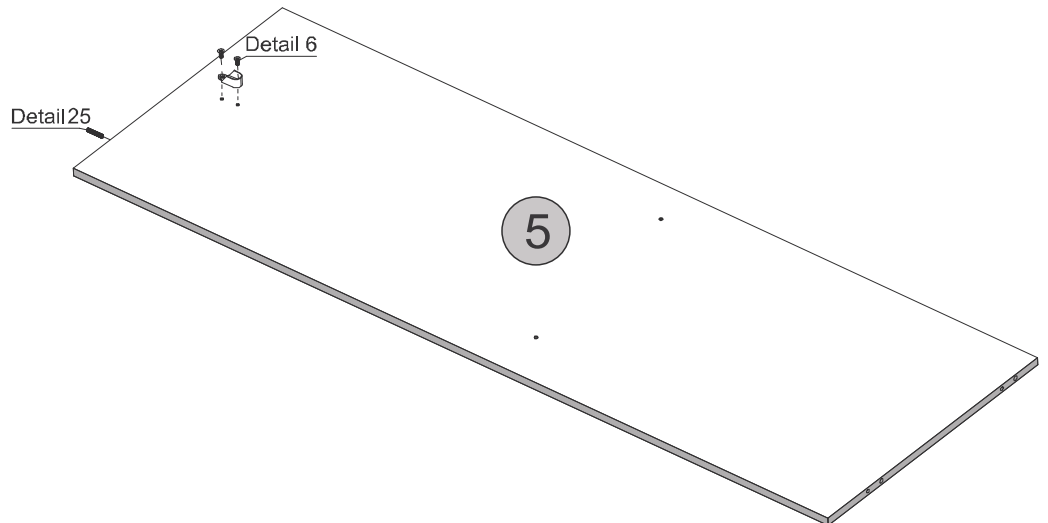
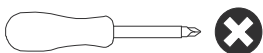
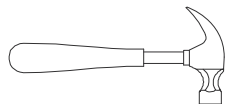

Detail 25

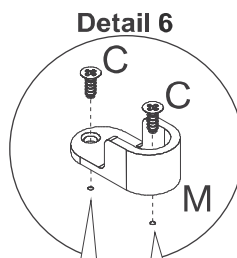

**Please note:
Pre-marked
Holes**

STEP 11

PARTS REQUIRED

5- LEFT DIVISION PANEL x1

HARDWARE REQUIRED

D  04

TOOLS REQUIRED

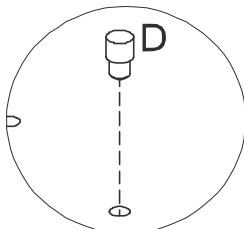
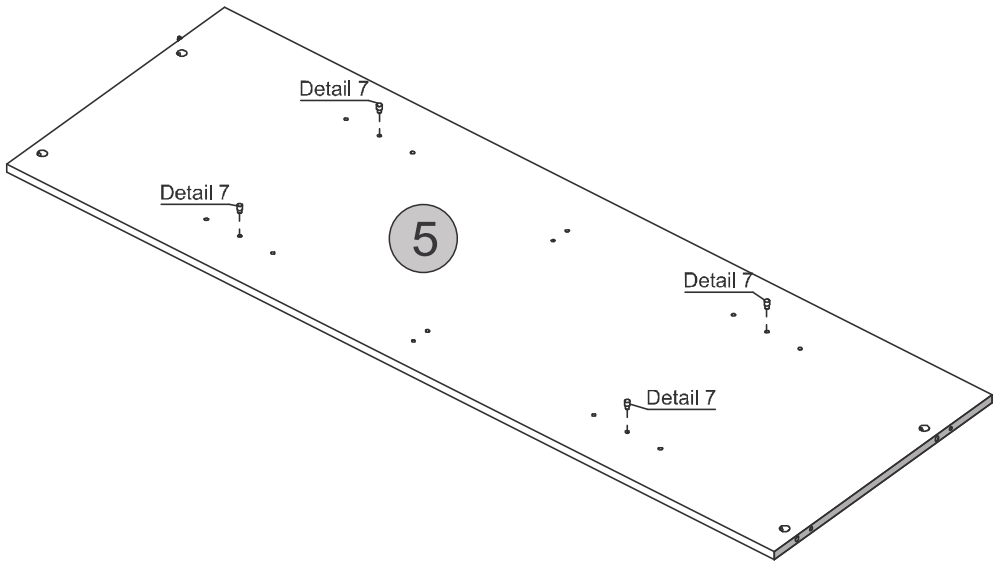
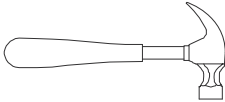

Detail 7

STEP 12

PARTS REQUIRED

4- TOP PANEL x1

HARDWARE REQUIRED

C  05

E  04

J  05

V  01

TOOLS REQUIRED

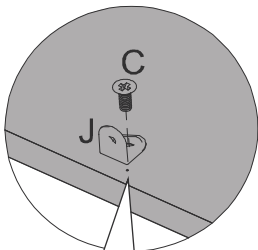
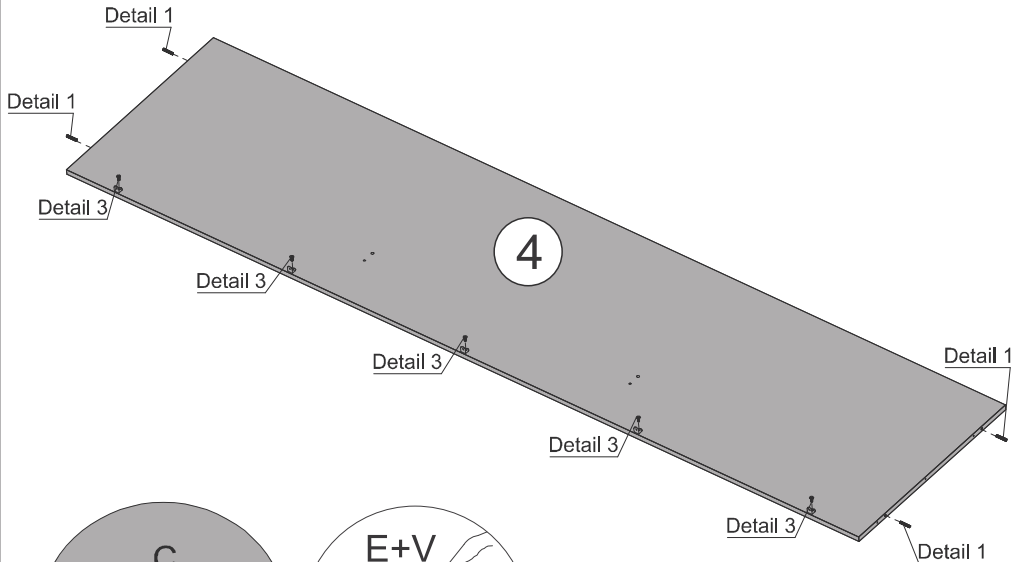
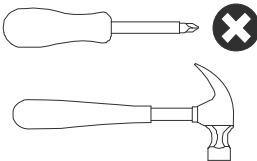

**Please note:
Pre-marked
Hole**

Detail 3

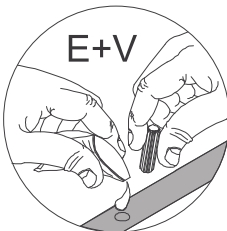

Detail 1

STEP 13

PARTS REQUIRED

4 - TOP PANEL x1

HARDWARE REQUIRED

O  06

Z  01

TOOLS REQUIRED

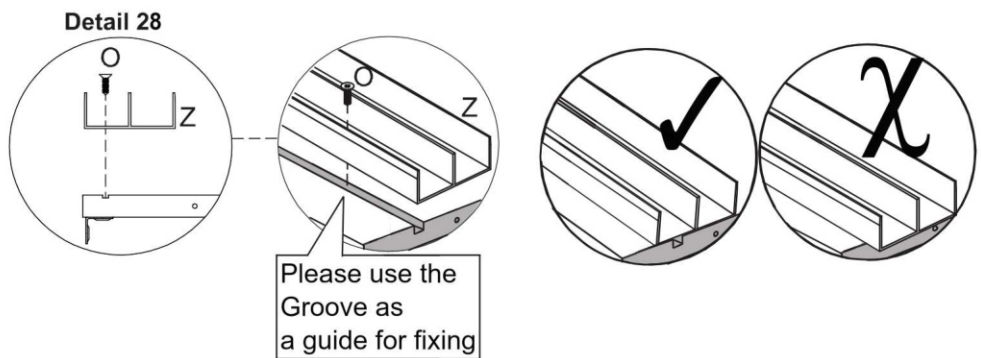
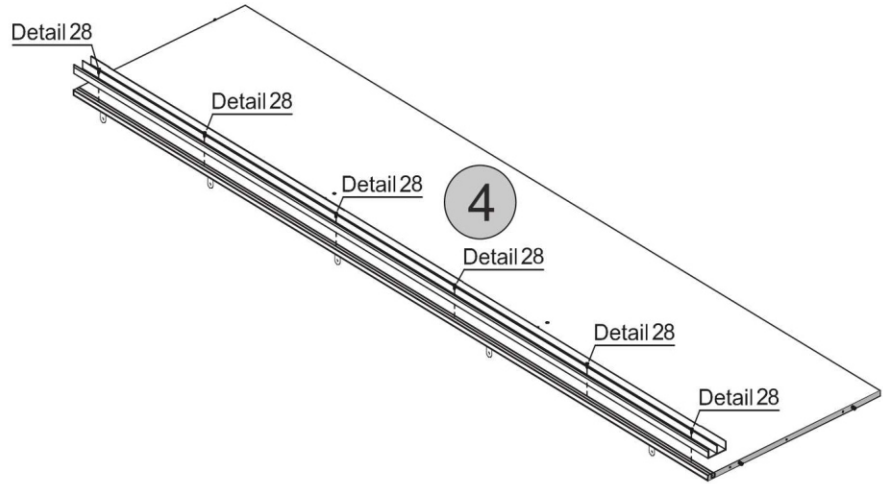

STEP 14

PARTS REQUIRED

4 - TOP PANEL x1

HARDWARE REQUIRED

A  02

O  06

Z  01

TOOLS REQUIRED

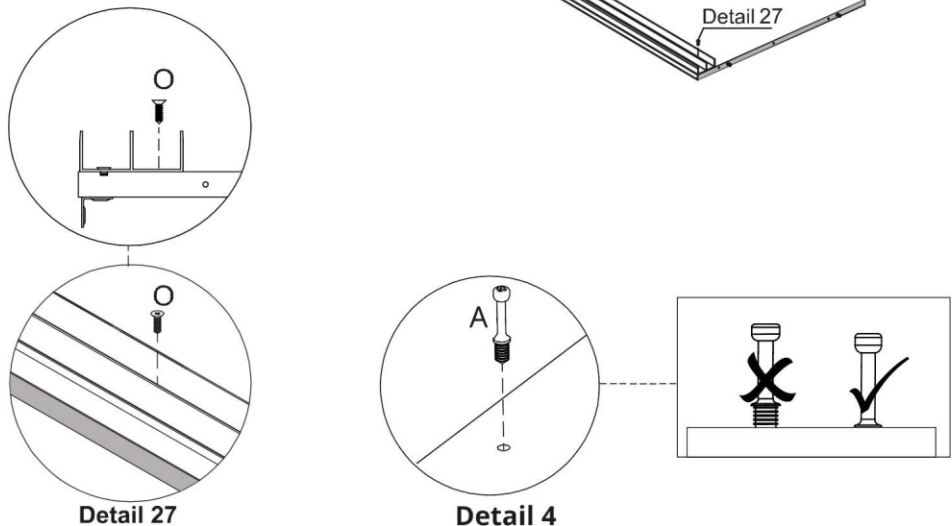
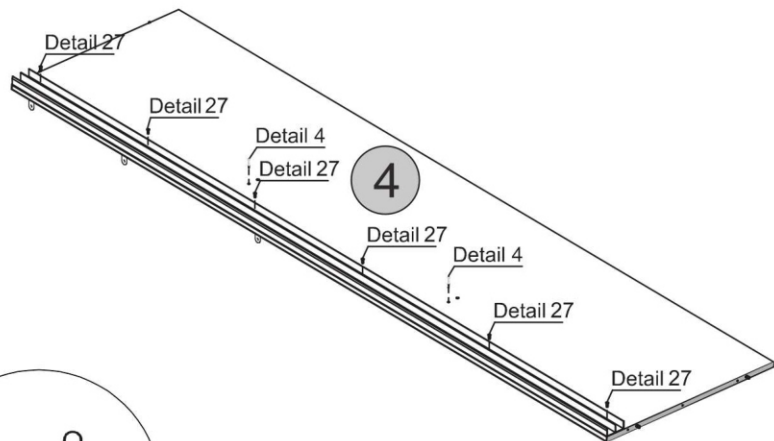

STEP 15

PARTS REQUIRED

15- LARGE SHELF PANEL x1

HARDWARE REQUIRED

A  02

E  04

V  01

TOOLS REQUIRED

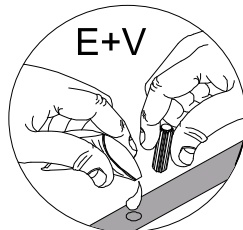
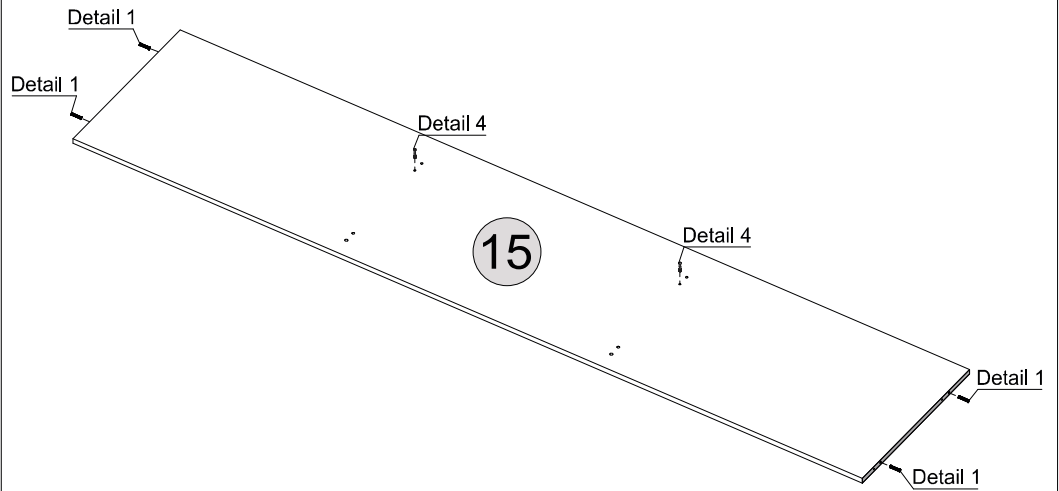
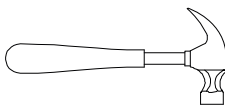
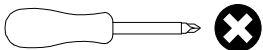

Detail 1

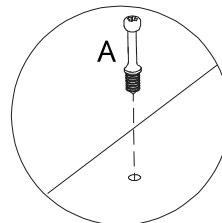

Detail 4

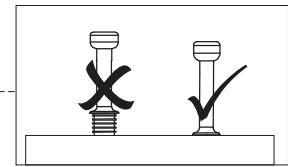

STEP 16

PARTS REQUIRED

7- FRONT BASEBOARD x1

8- BACK BASEBOARD x1

9- CROSSBEAM x2

HARDWARE REQUIRED

C  04

V  01

TOOLS REQUIRED

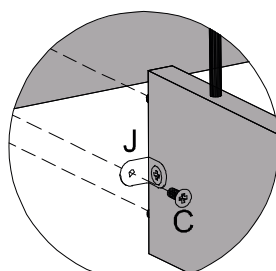
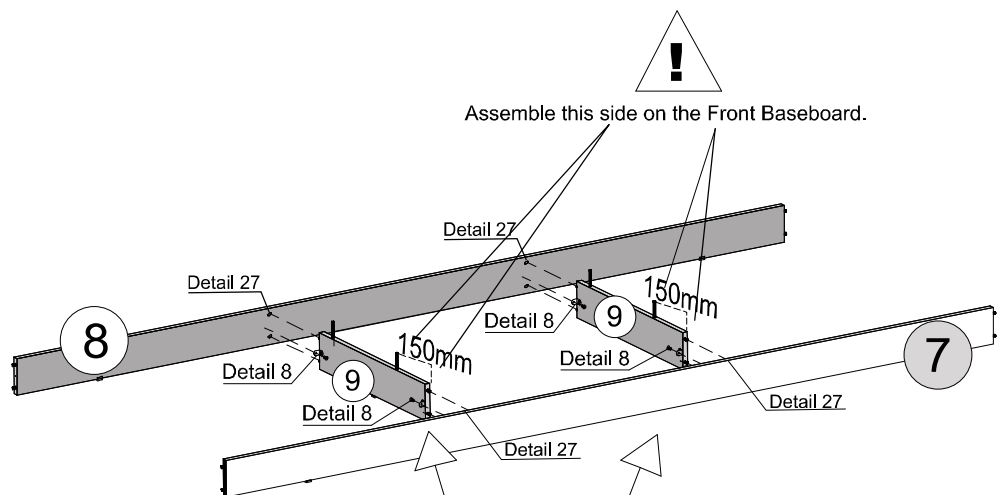
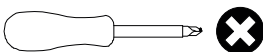

Detail 8

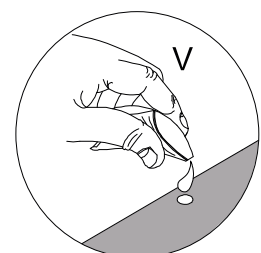
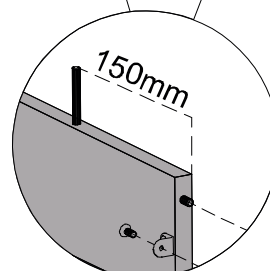

Detail 27

STEP 17

PARTS REQUIRED

2- LEFT SIDE x1

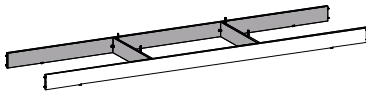

HARDWARE REQUIRED

F 02

U 02

V 01

TOOLS REQUIRED

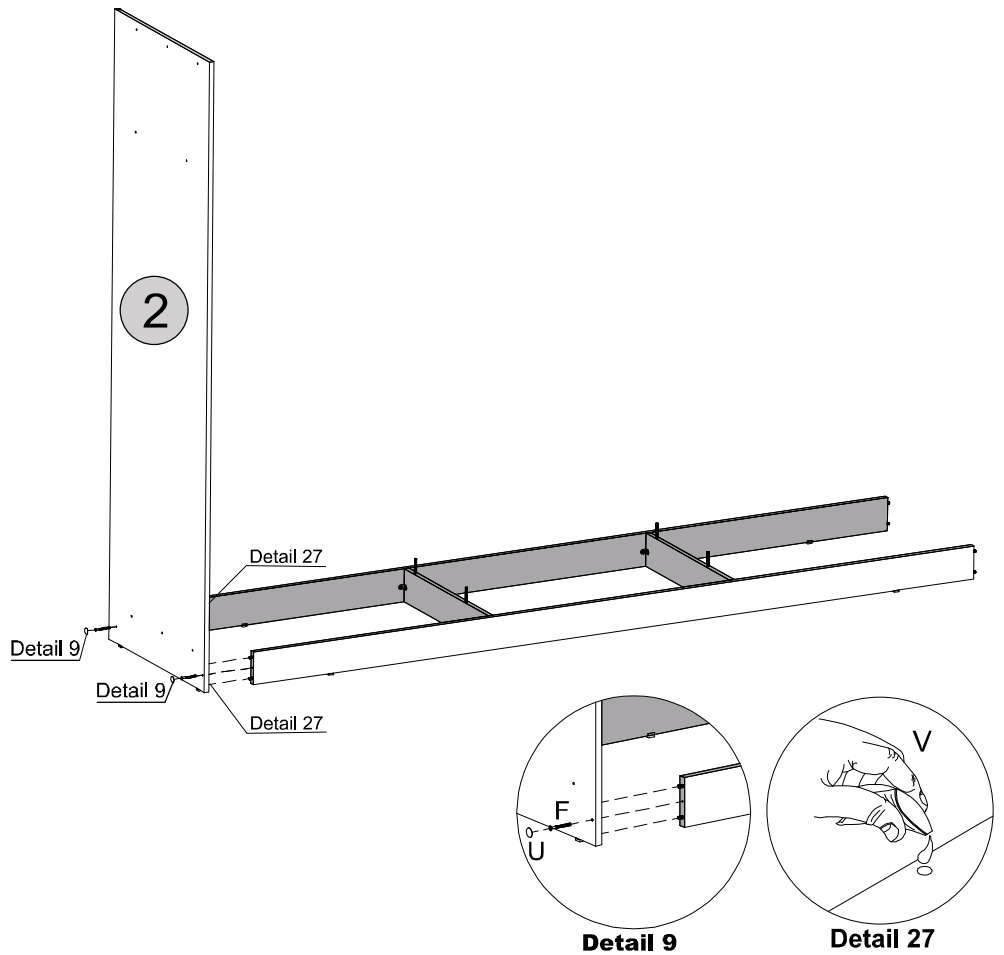
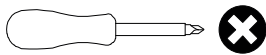

STEP 18

PARTS REQUIRED

1- BASE PANEL x1

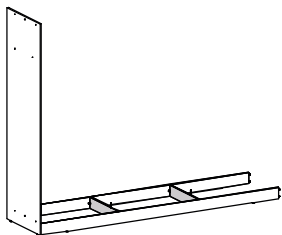

HARDWARE REQUIRED

F 03

U 03

V 01

TOOLS REQUIRED

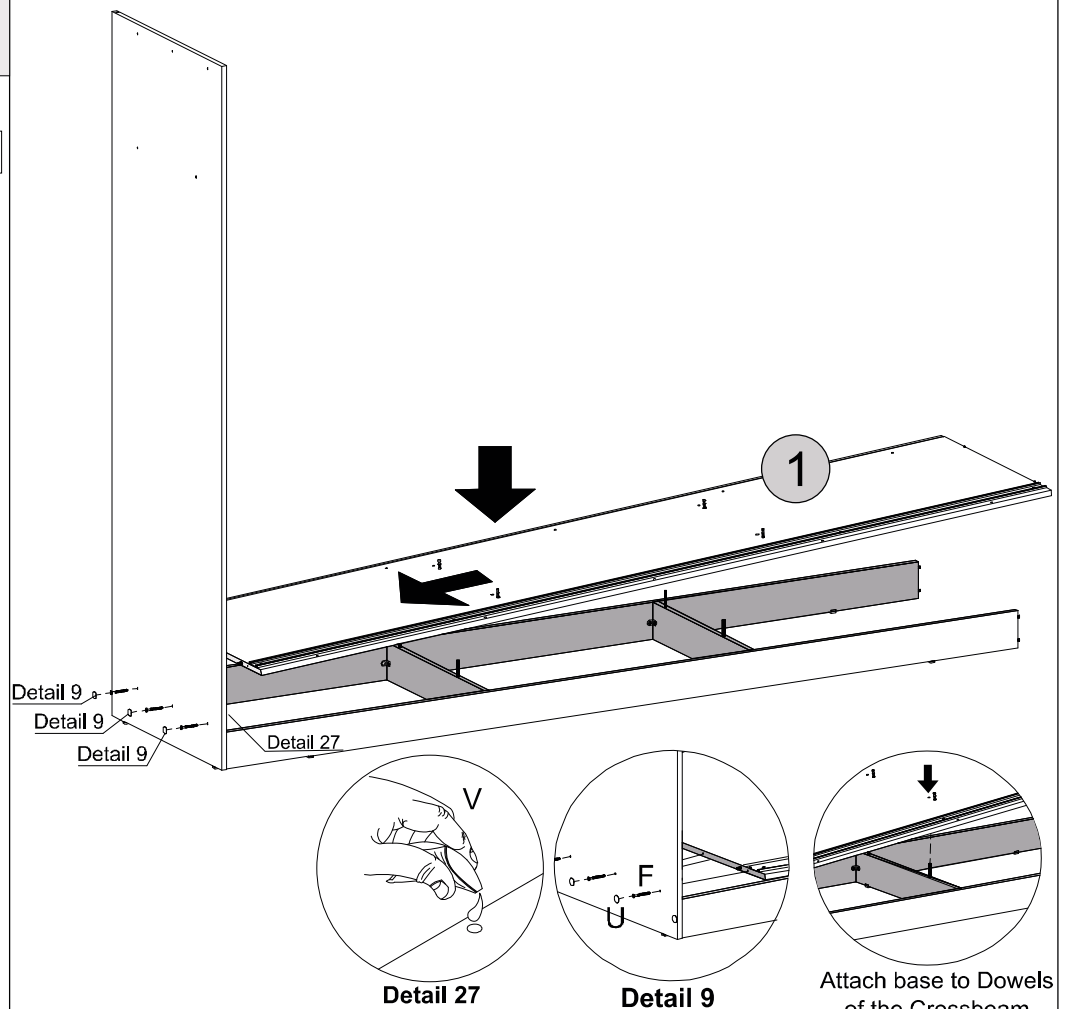
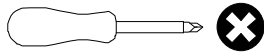

STEP 19

PARTS REQUIRED

6- RIGHT SIDE x1

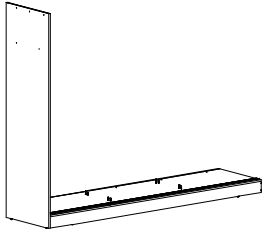

HARDWARE REQUIRED

F  05

U  05

V  01

TOOLS REQUIRED

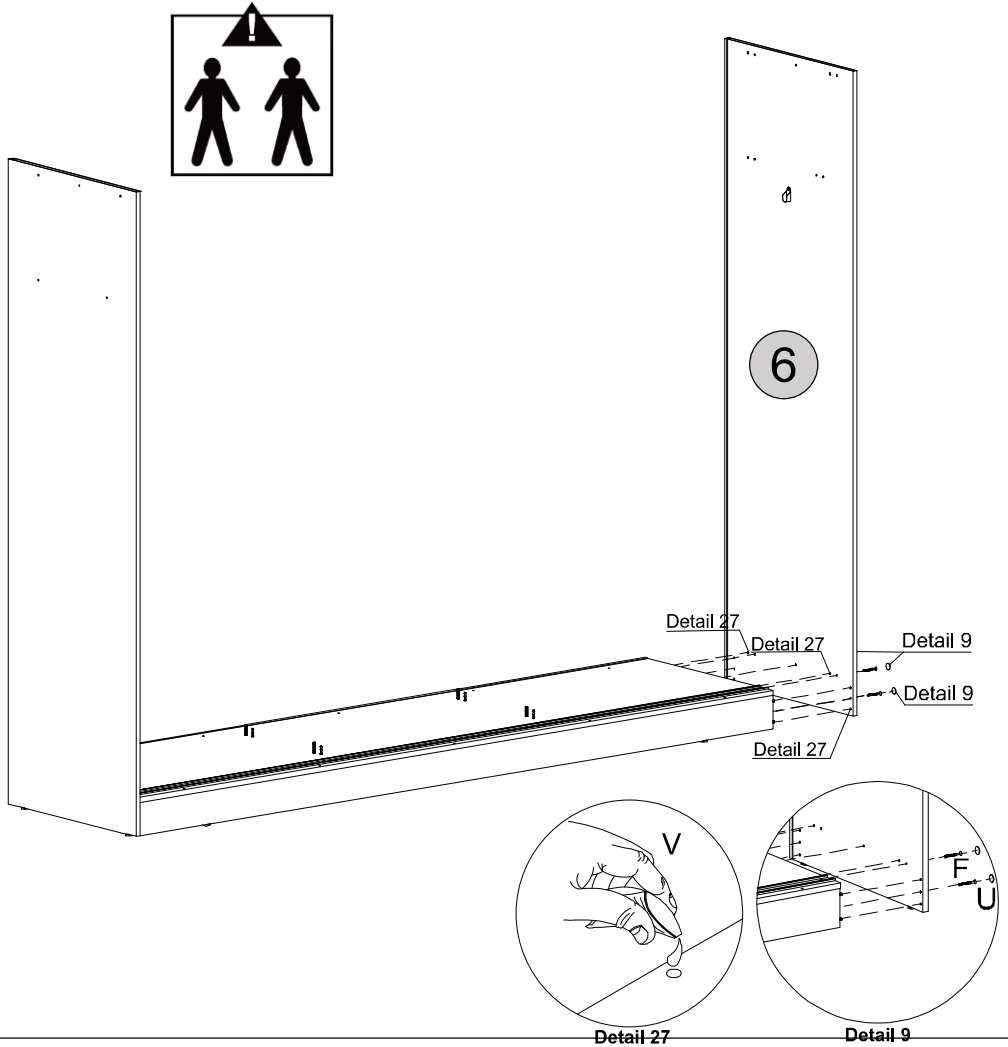
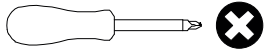

STEP 20

PARTS REQUIRED

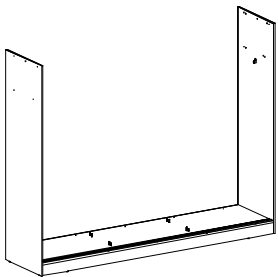

HARDWARE REQUIRED

R  10

U  10

TOOLS REQUIRED

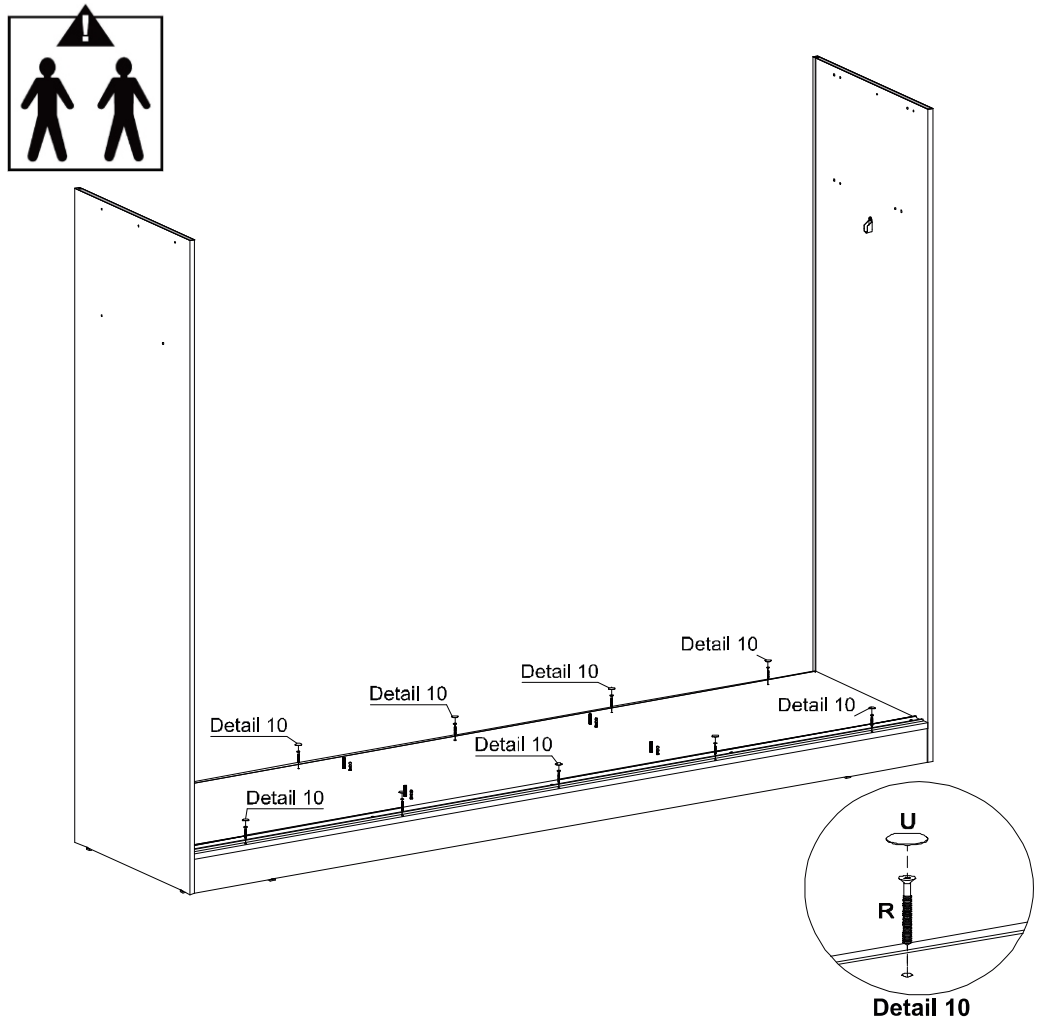
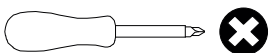

STEP 21

PARTS REQUIRED

3- LEFT DIVISION PANEL x1

5- RIGHT DIVISION PANEL x1

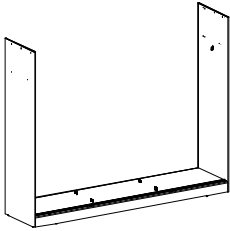

HARDWARE REQUIRED

B  04

G1  04

V  01

TOOLS REQUIRED

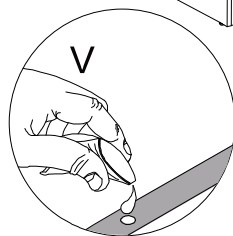
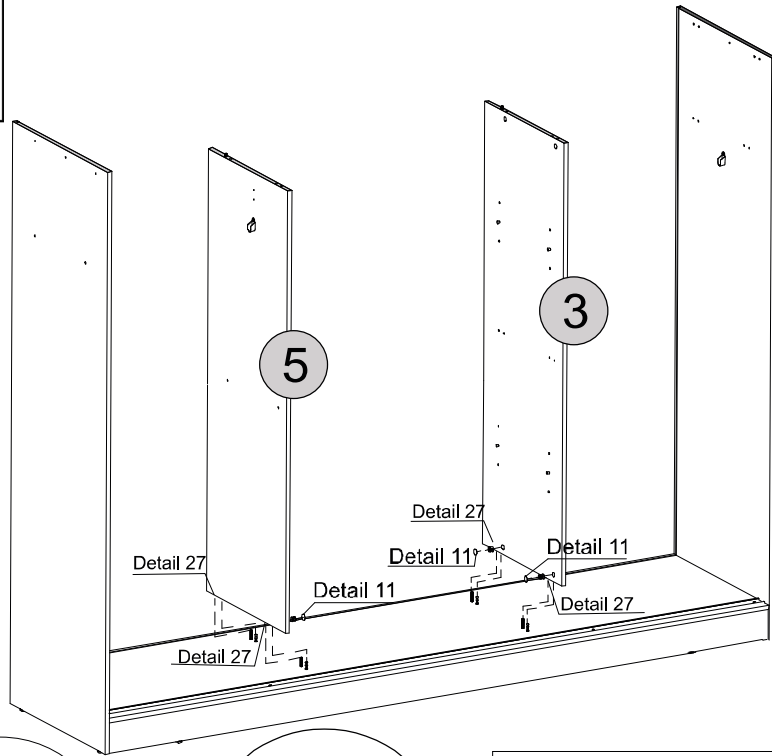
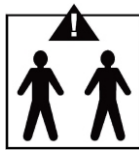
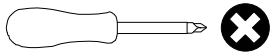

Detail 27

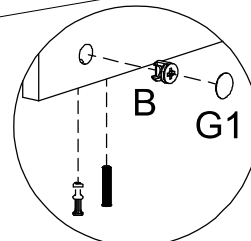

Detail 11

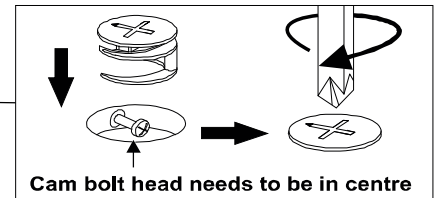

Cam bolt head needs to be in centre

STEP 22

PARTS REQUIRED

11- FIXED SHELF x 1

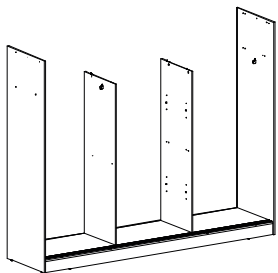

HARDWARE REQUIRED

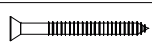
F  04

V  01

G1  04

TOOLS REQUIRED

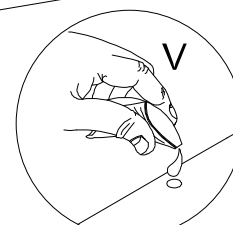
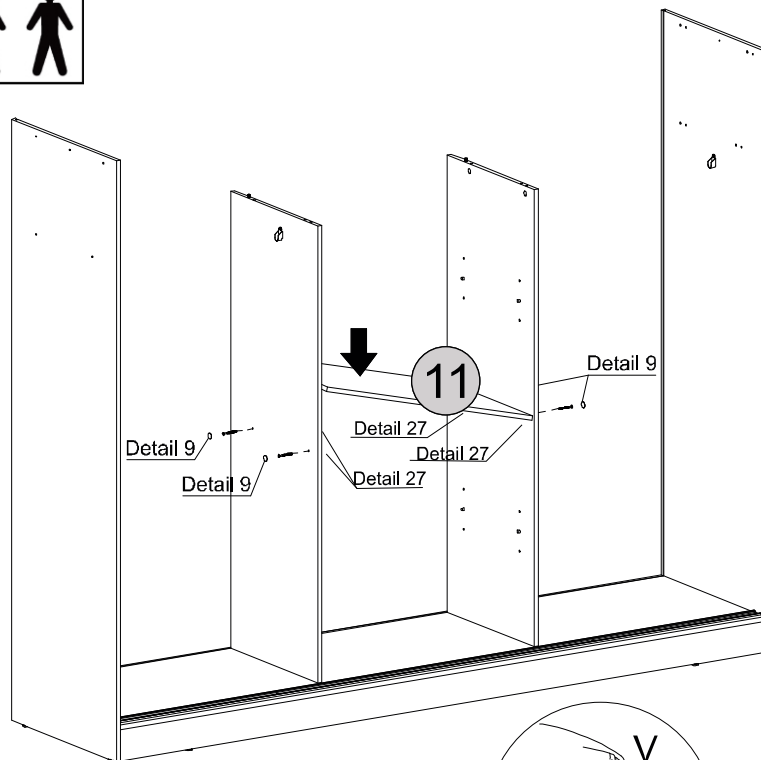
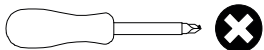

Detail 27

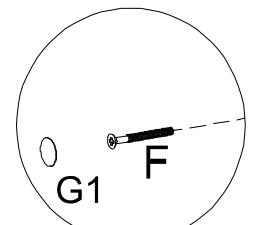

Detail 9

STEP 23

PARTS REQUIRED

15- LARGE SHELF PANEL x1

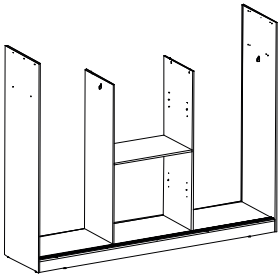

HARDWARE REQUIRED

B  02

F  04

U  04

V  01

G1  02

TOOLS REQUIRED

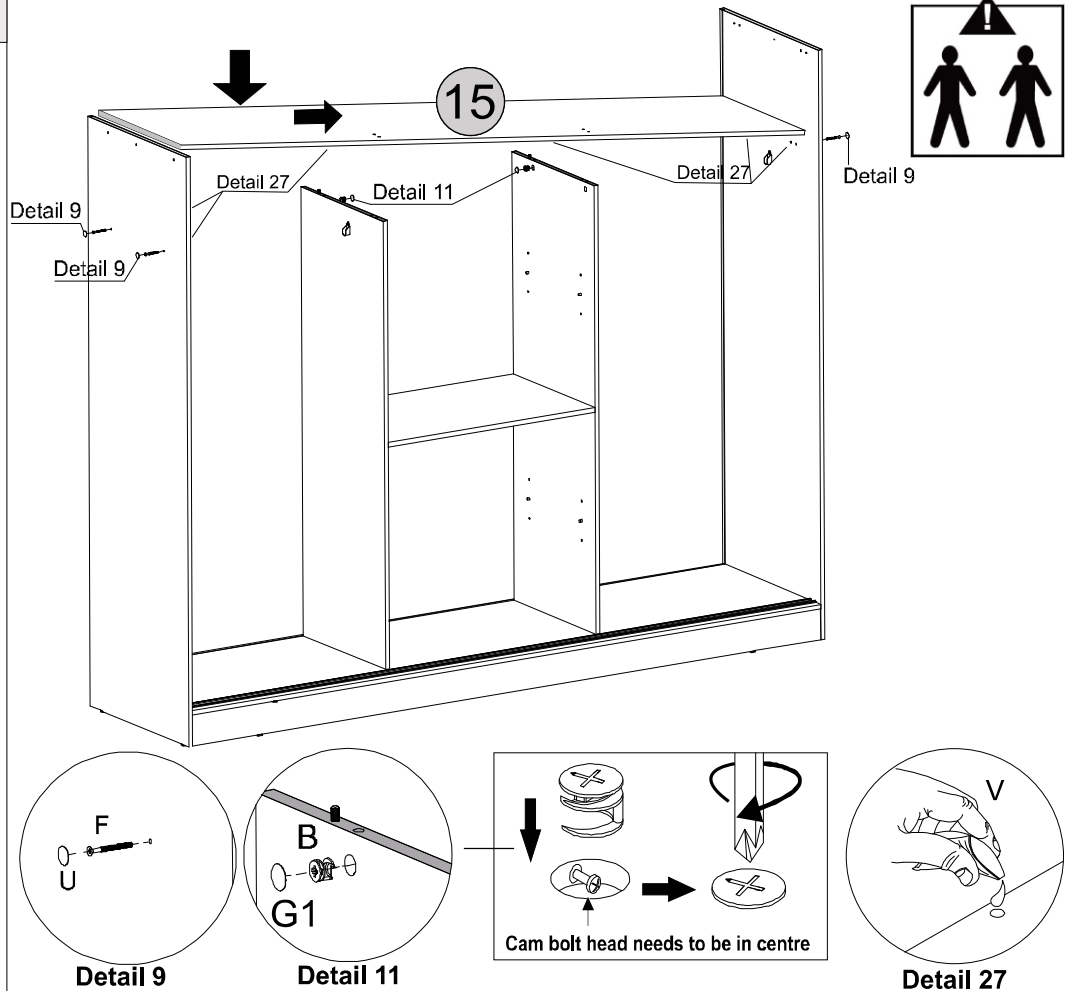
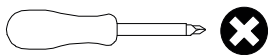

STEP 24

PARTS REQUIRED

14- SMALL DIVIDER PANEL x2

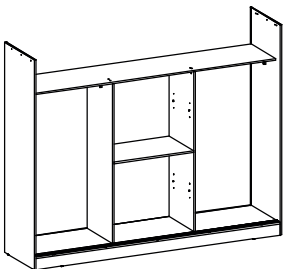

HARDWARE REQUIRED

B  04

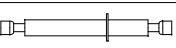
Q  02

V  01

G1  04

TOOLS REQUIRED

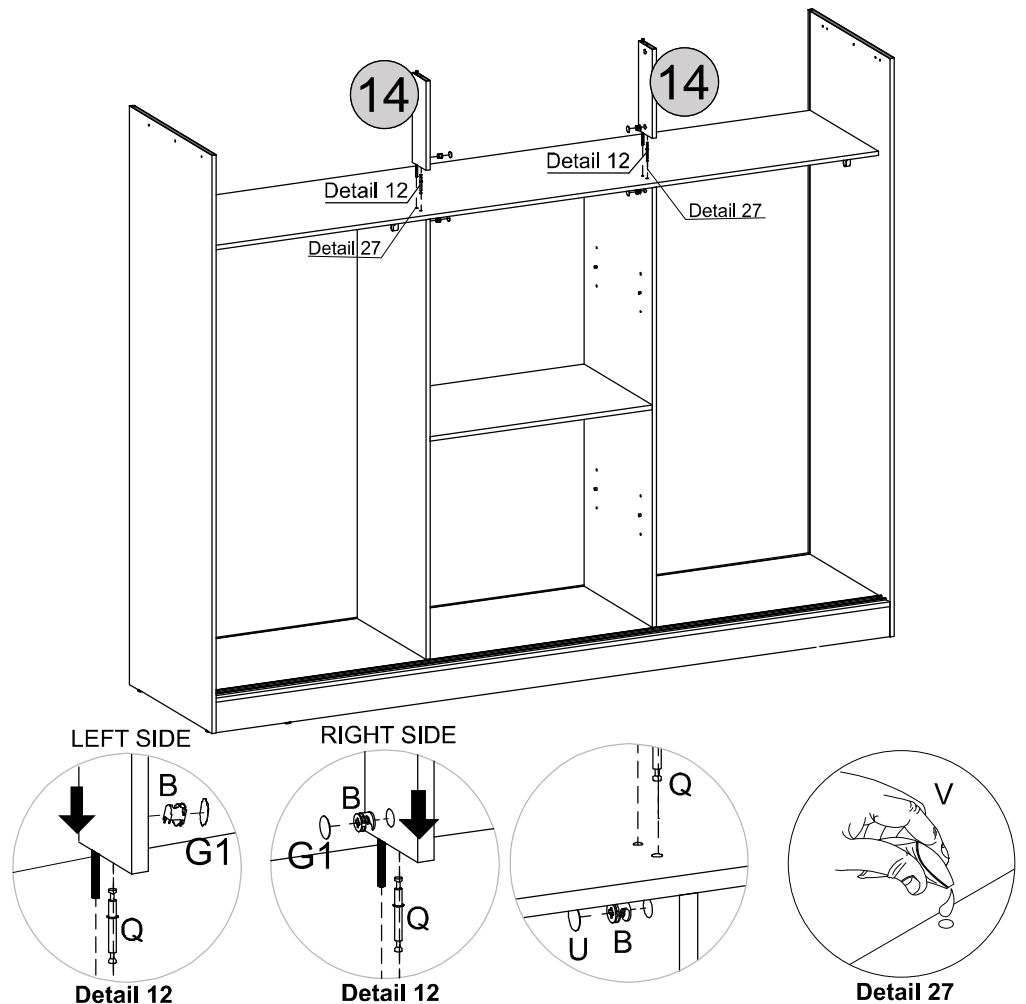
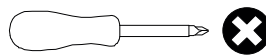

STEP 25

PARTS REQUIRED

4- TOP PANEL x1

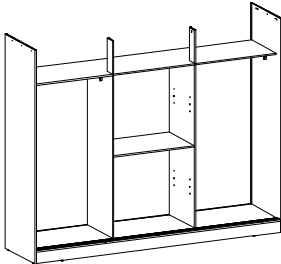

HARDWARE REQUIRED

B  02

F  06

U  08

V  01

G1  02

TOOLS REQUIRED

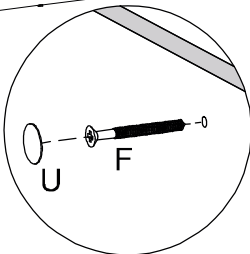
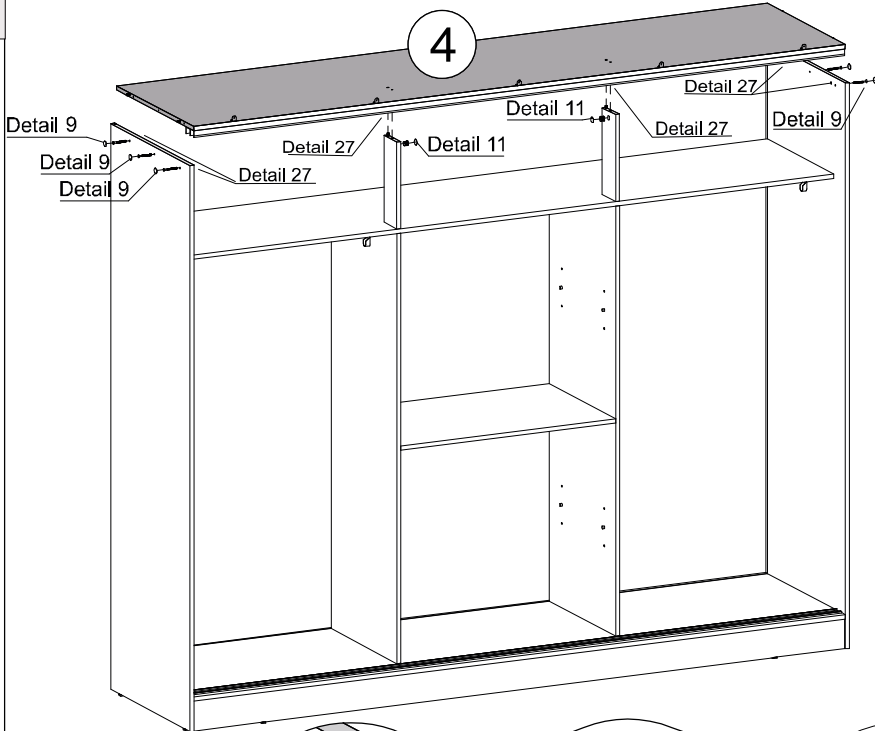

Detail 9

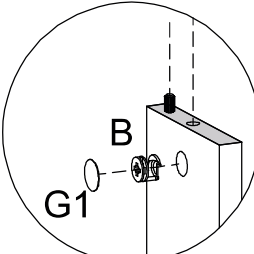

Detail 11

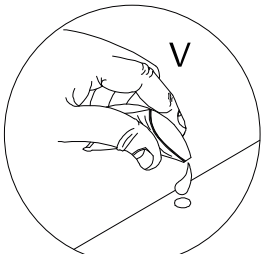

Detail 27

STEP 26

PARTS REQUIRED

13- BACK PANEL x2

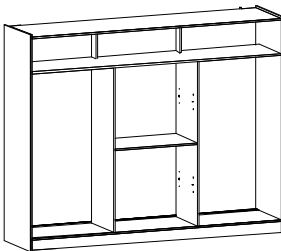

HARDWARE REQUIRED

H  06

TOOLS REQUIRED

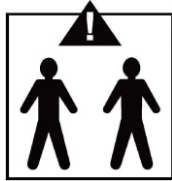
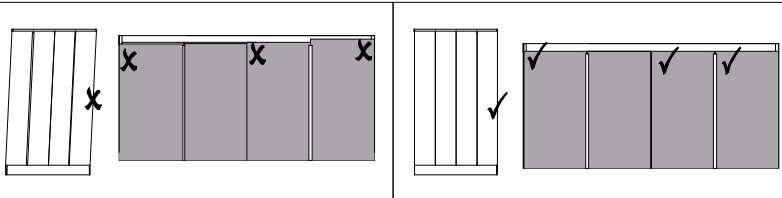
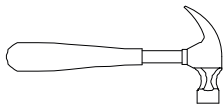

* For your future reference Order Number should be here

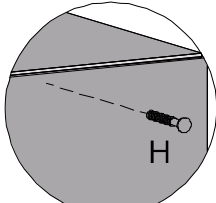
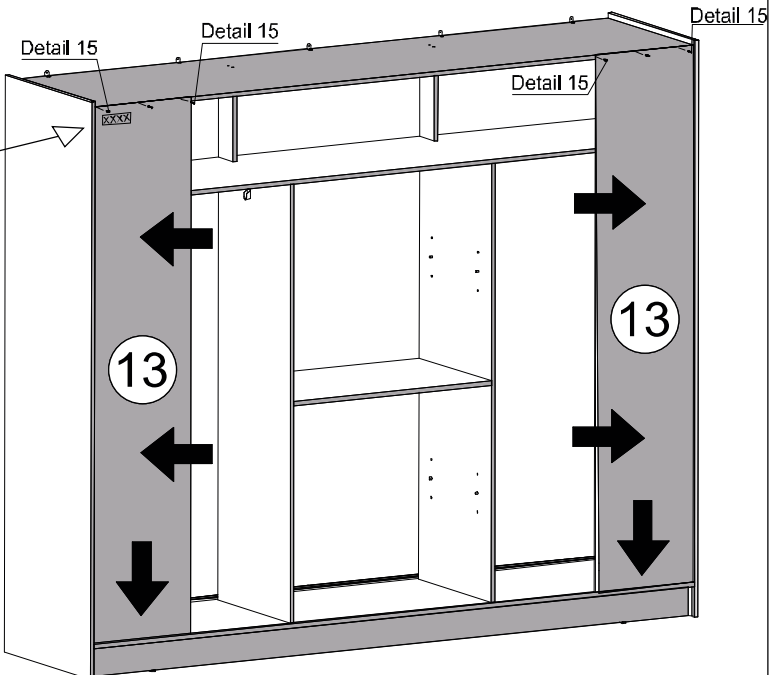

Detail 15

STEP 27

PARTS REQUIRED

13 - BACK PANEL x2

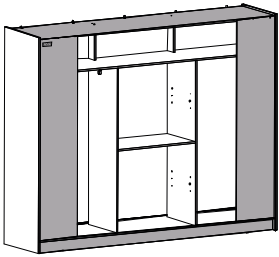

HARDWARE REQUIRED

H  06

C1  02

TOOLS REQUIRED

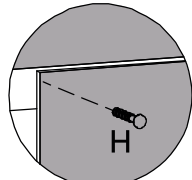
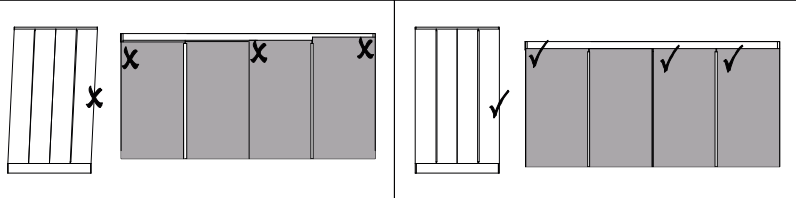
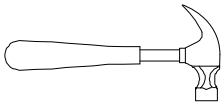

Detail 15

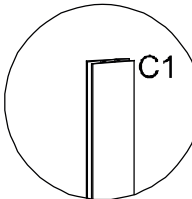

Detail 16

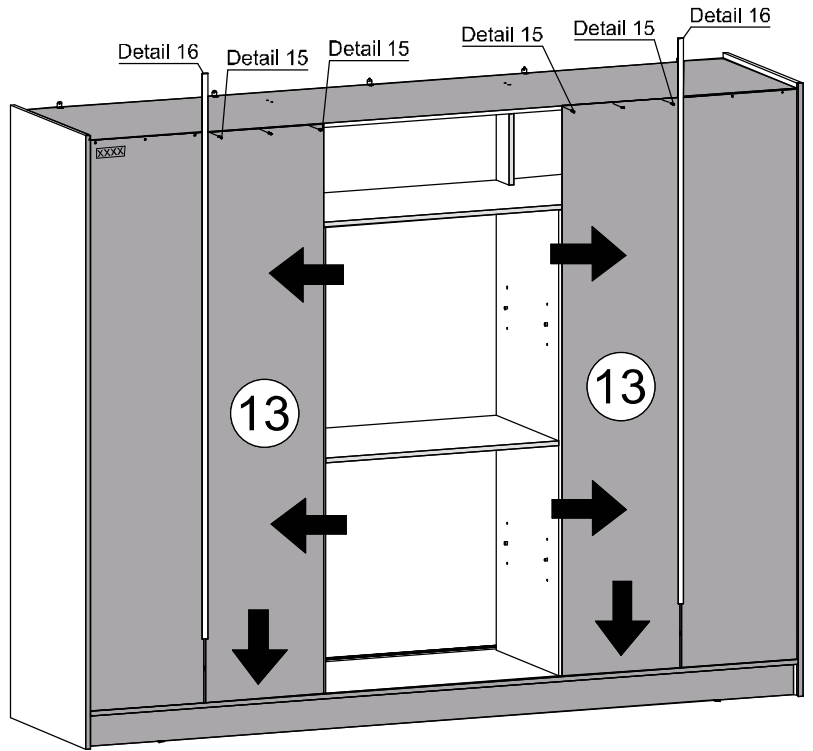

STEP 28

PARTS REQUIRED

13 - BACK PANEL x2

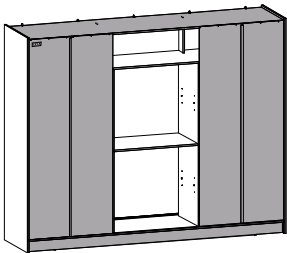

HARDWARE REQUIRED

H  20

I  14

C1  01

E1  02

TOOLS REQUIRED

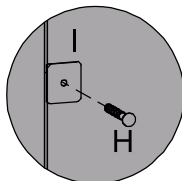
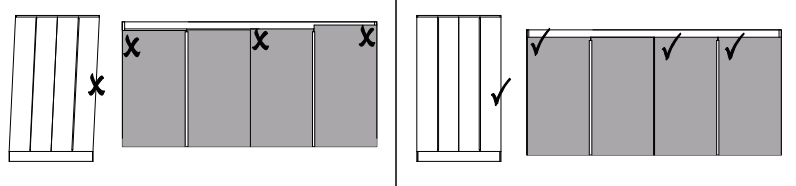
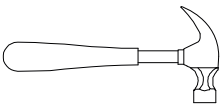

Detail 14

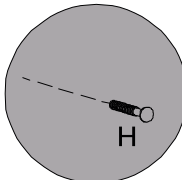

Detail 15

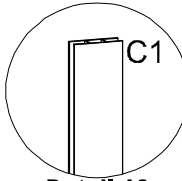

Detail 16

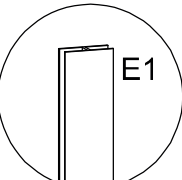

Detail 24

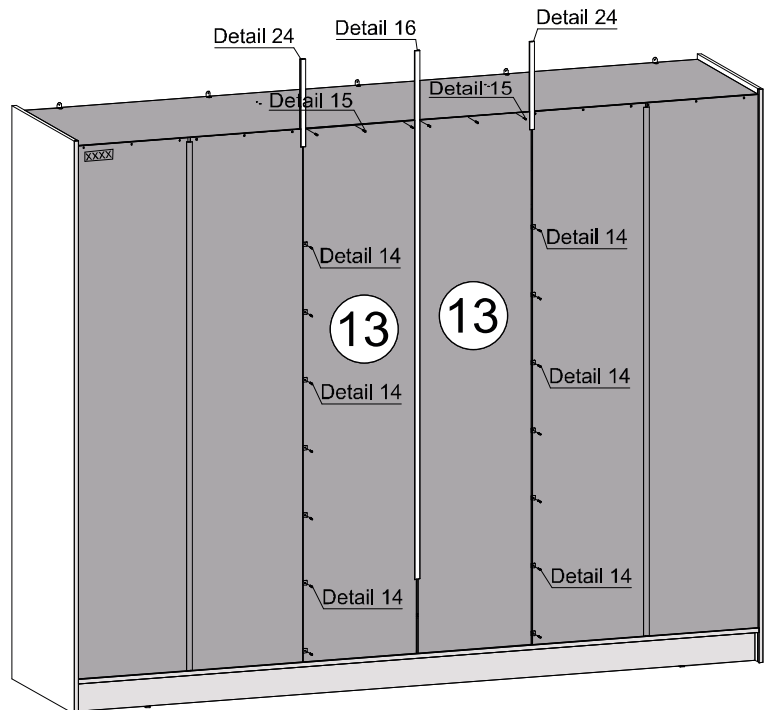

STEP 29

PARTS REQUIRED

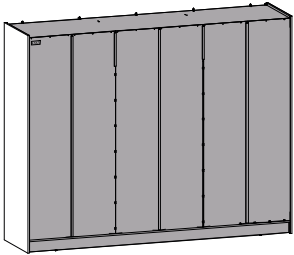

HARDWARE REQUIRED

H		24
---	--	----

P		32
---	--	----

T		32
---	--	----

TOOLS REQUIRED

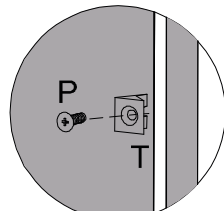
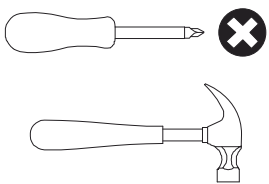

Detail 17

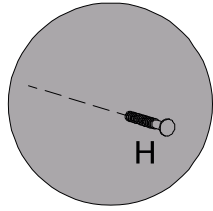

Detail 15

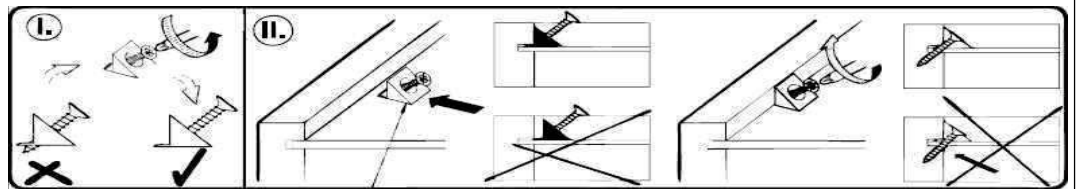
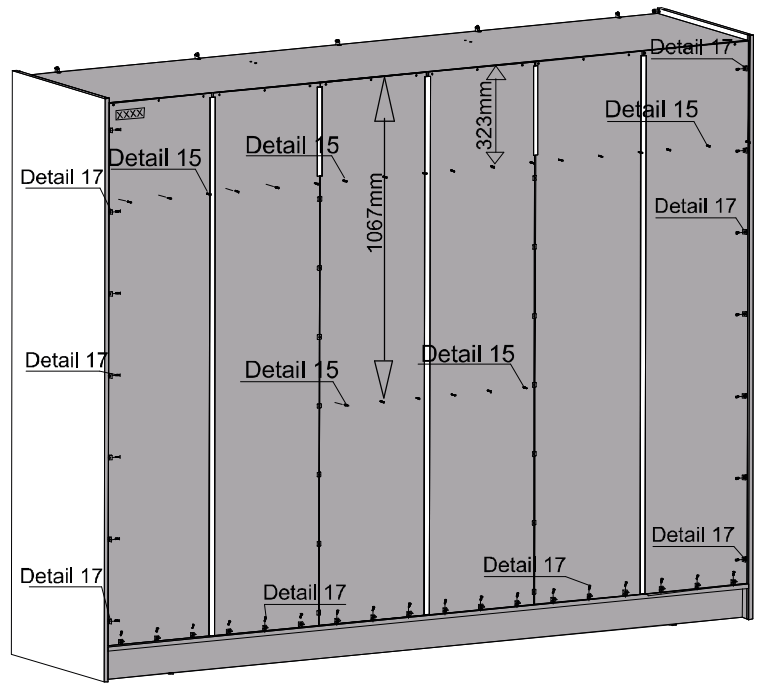

STEP 30

PARTS REQUIRED

16 - MOVABLE SHELF	×2
--------------------	----

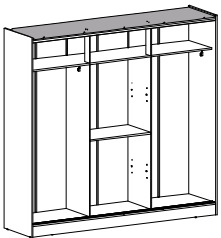

HARDWARE REQUIRED

Y		01
---	--	----

D1		02
----	--	----

F1		04
----	--	----

F1		04
----	--	----

TOOLS REQUIRED

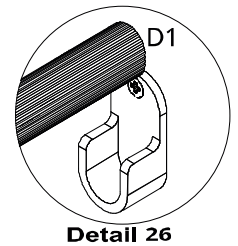
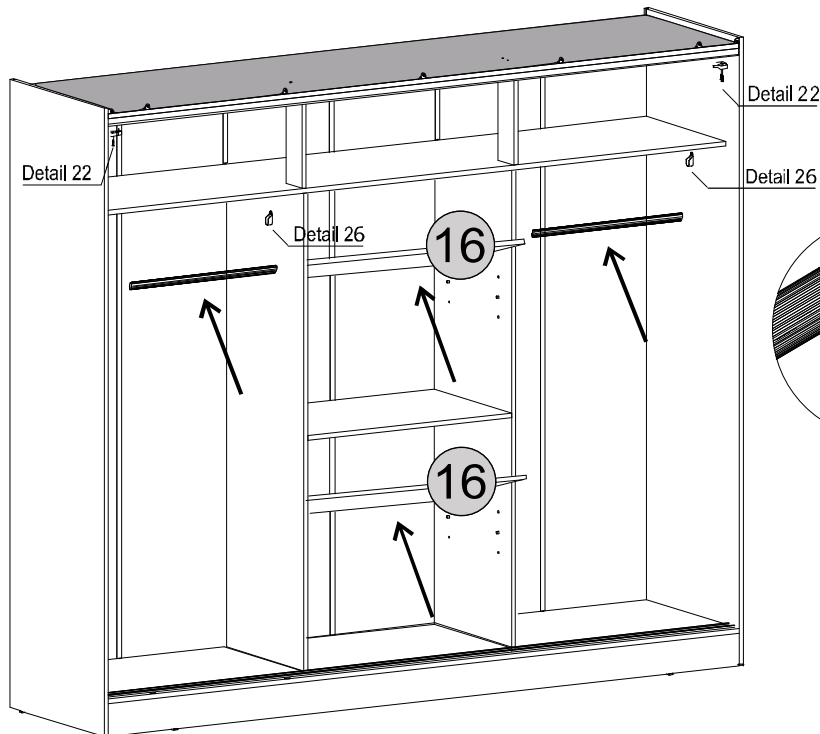
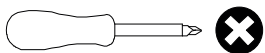

Detail 26

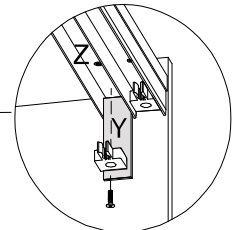
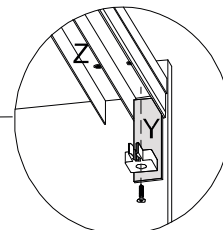
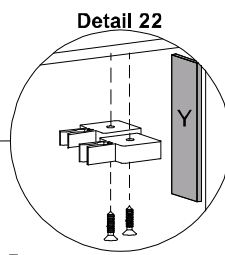
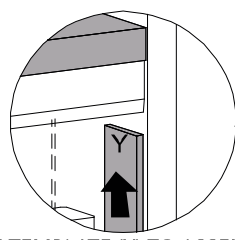

USE TEMPLATE (Y) TO ASSEMBLE THE SLIDING SYSTEM BRAKE

MAKE THIS ASSEMBLY ON BOTH SIDES OF THE WARDROBE

STEP 31

PARTS REQUIRED

10- FRAME x1

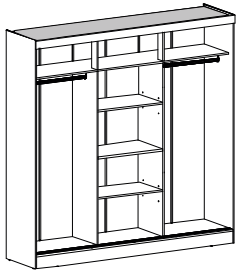

HARDWARE REQUIRED

C  02

TOOLS REQUIRED

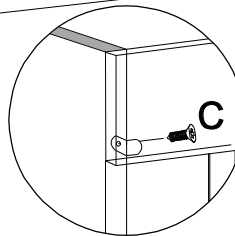
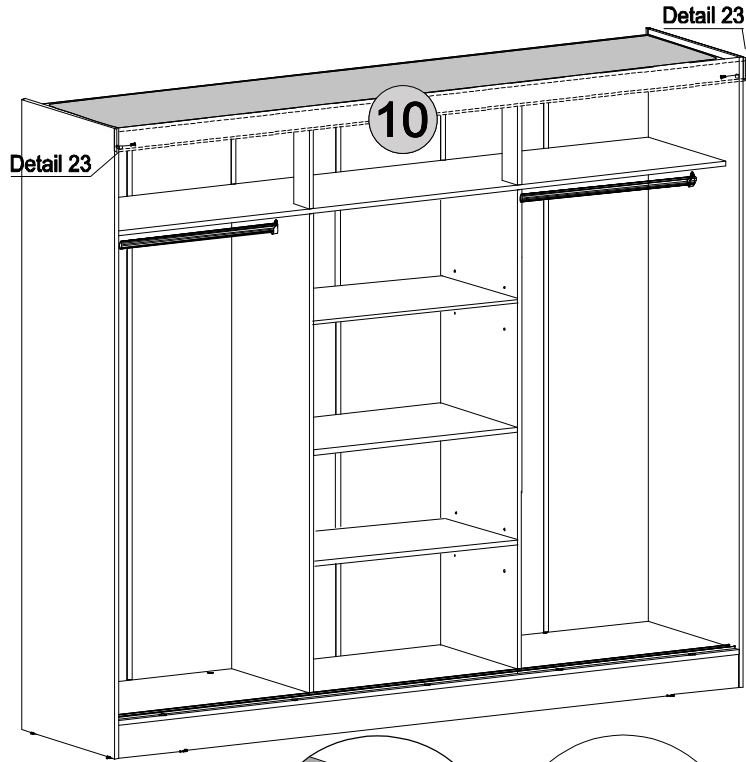
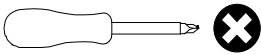

Detail 23

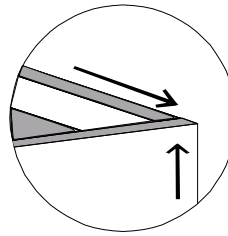

Align Corners

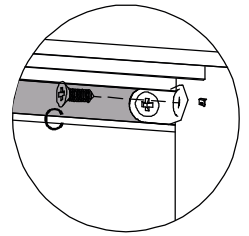

Detail 23

STEP 32

PARTS REQUIRED

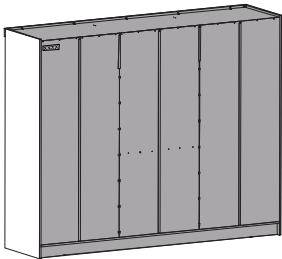

HARDWARE REQUIRED

C  09

J  02

TOOLS REQUIRED

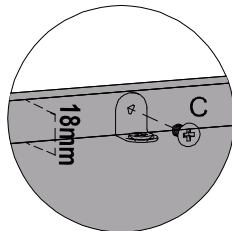
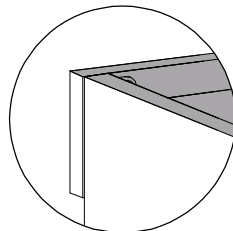
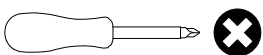

Detail 13

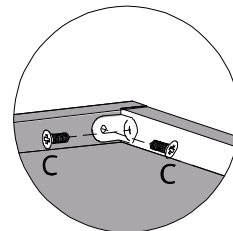

Detail 13

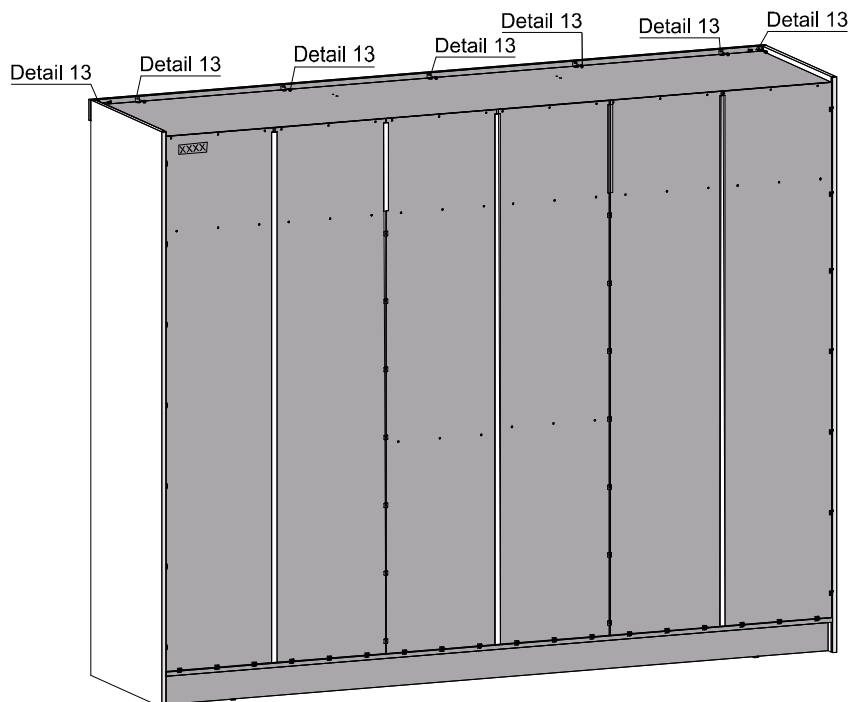



STEP 33

PARTS REQUIRED

12- DOOR	x2
17- MIRRORED DOOR	x1

HARDWARE REQUIRED

B1		03
O		15

TOOLS REQUIRED

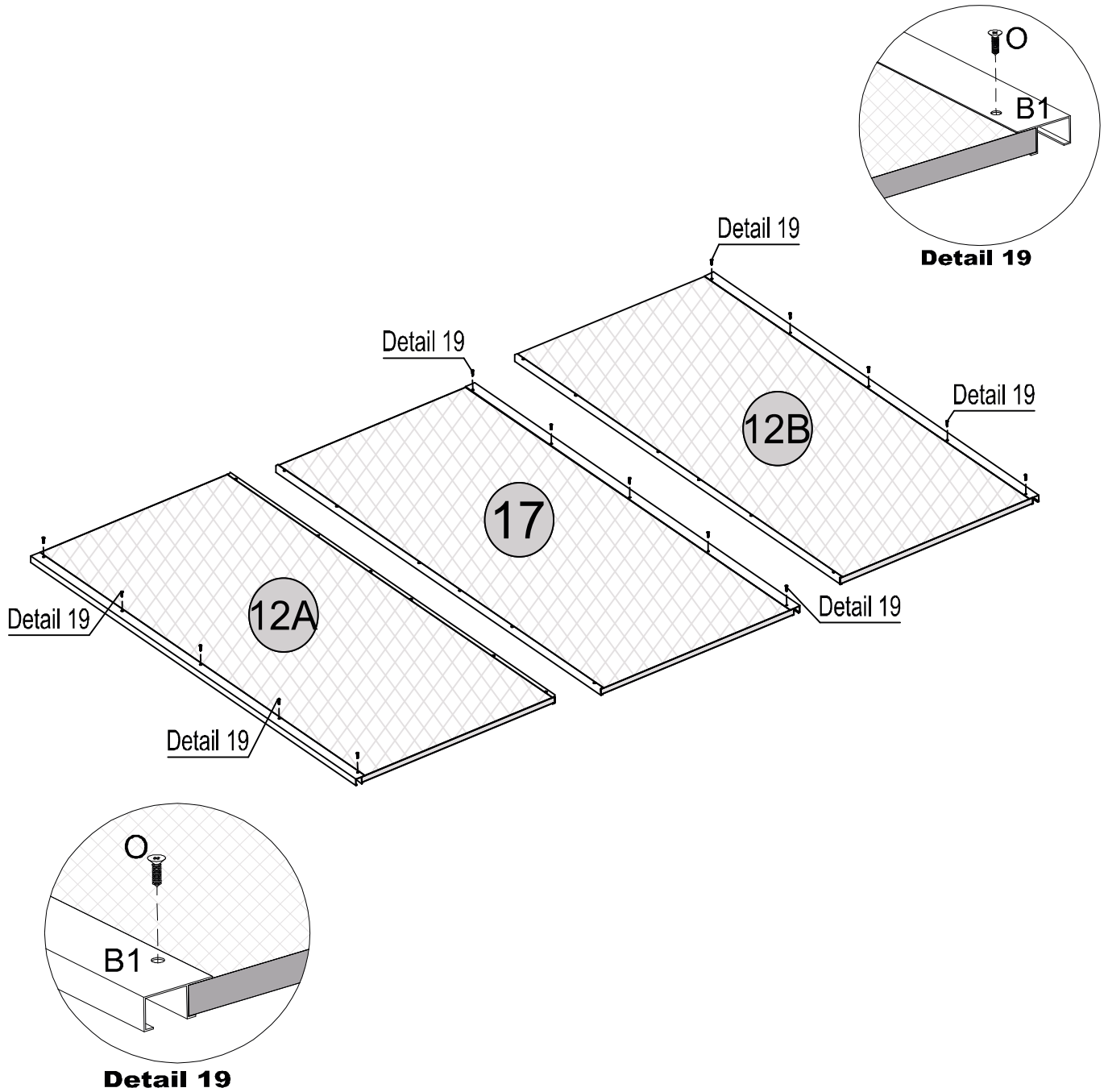
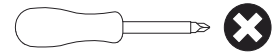

STEP 34

PARTS REQUIRED

HARDWARE REQUIRED

TOOLS REQUIRED

F1

SLIDING SYSTEM KIT

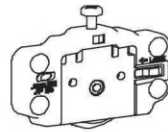

Lower Pulley x6

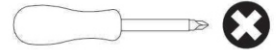
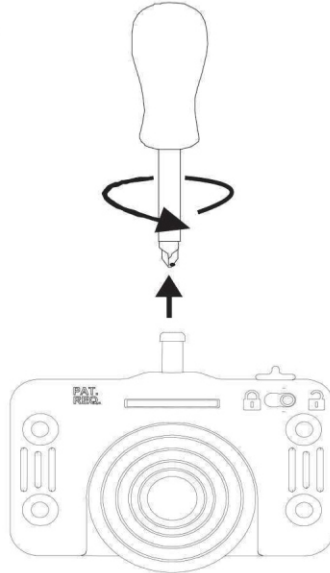
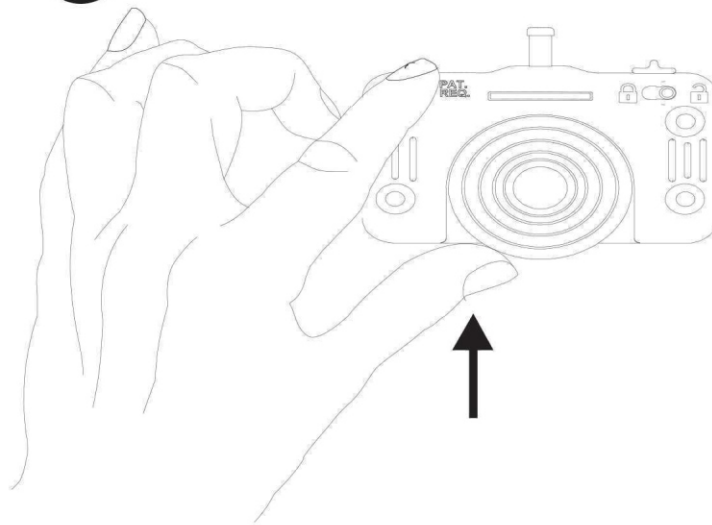
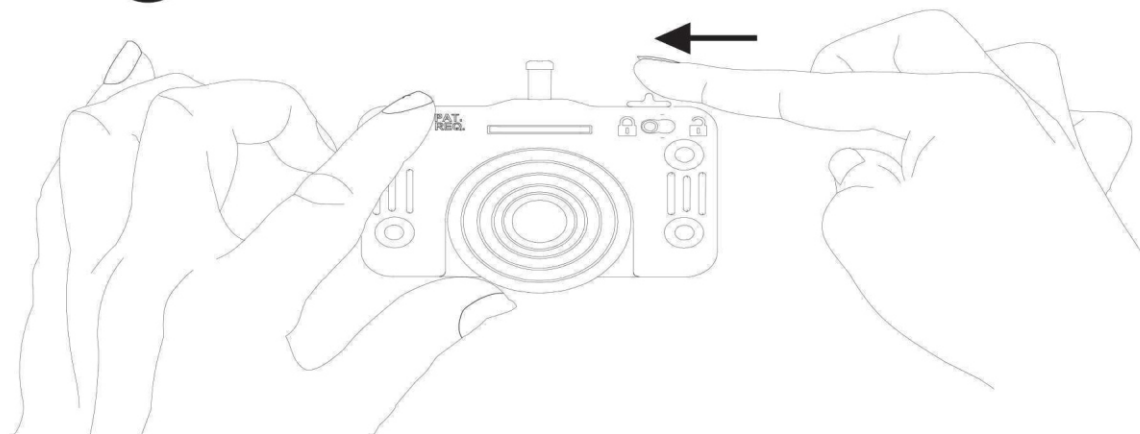
**1° UNSCREW****2° PUSH THE WHEEL UP UNTIL IT TOUCHES THE SCREW****3° SLIDE TO LOCK**

STEP 35

PARTS REQUIRED

12- DOOR x2

17- MİRRORED DOOR x1

HARDWARE REQUIRED

F1 SLIDING SYSTEM KIT

Lower Pulley X6

Upper Pulley X6

Screw Ø3.5 x 16 mm X36

TOOLS REQUIRED

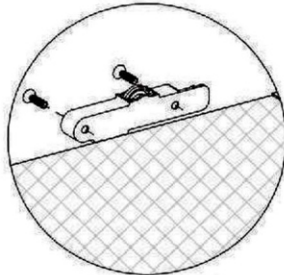
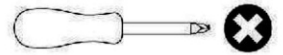

Detail 21

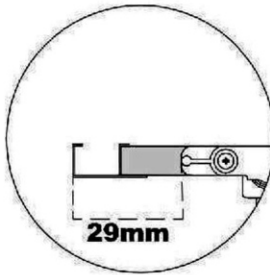

29mm

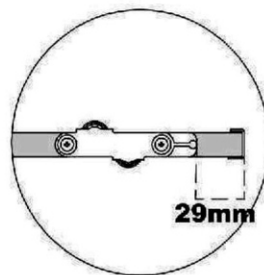

29mm

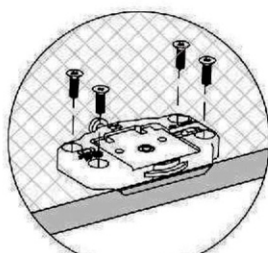
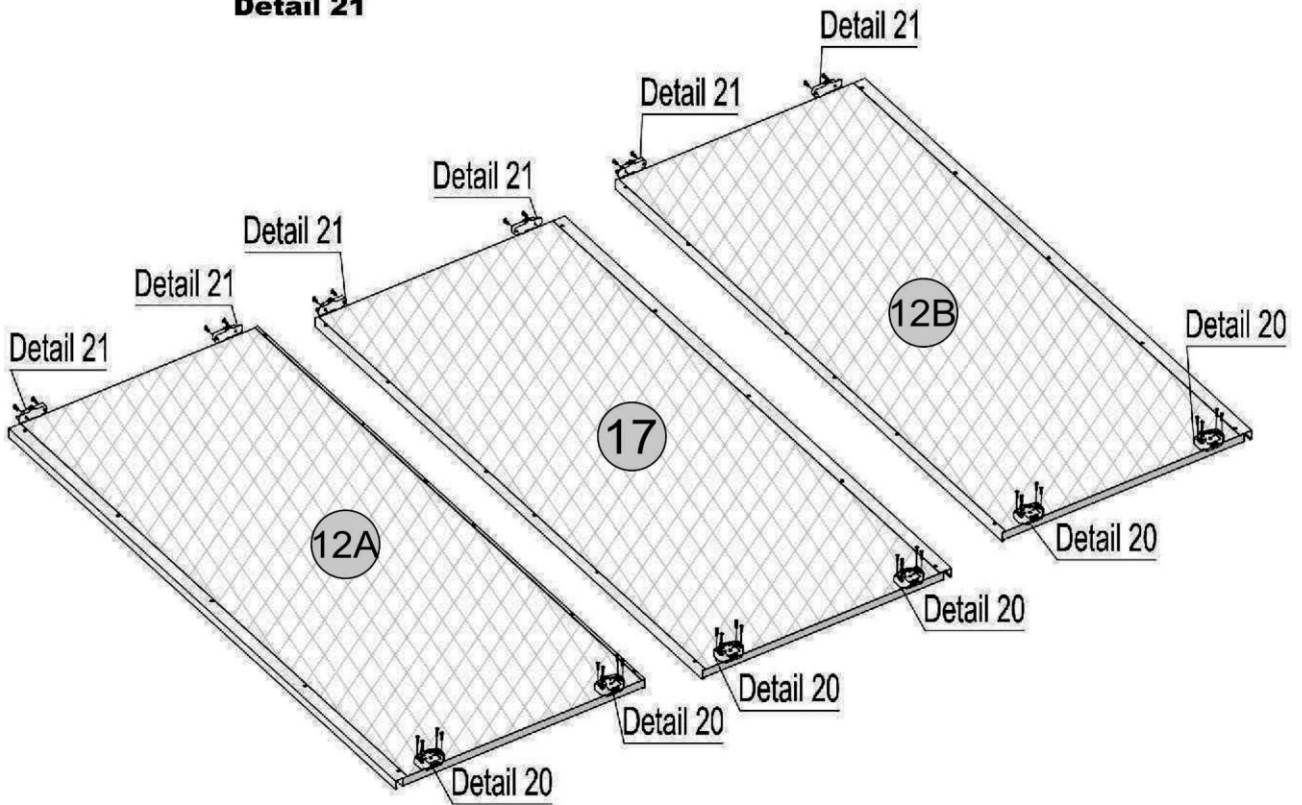

Detail 20

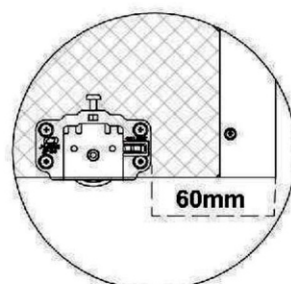

60mm

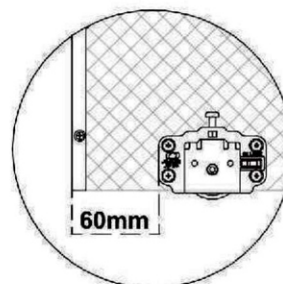

60mm

ATTENTION

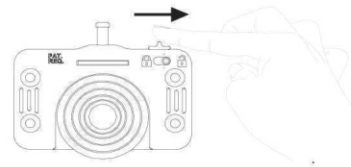
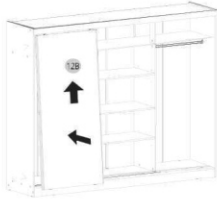

1°

Fit the Door

2°

Unlock the Pulley

STEP 36

PARTS REQUIRED

12- DOOR x1



HARDWARE REQUIRED

TOOLS REQUIRED

FIT ON BACK RAIL

FIT ON BACK RAIL

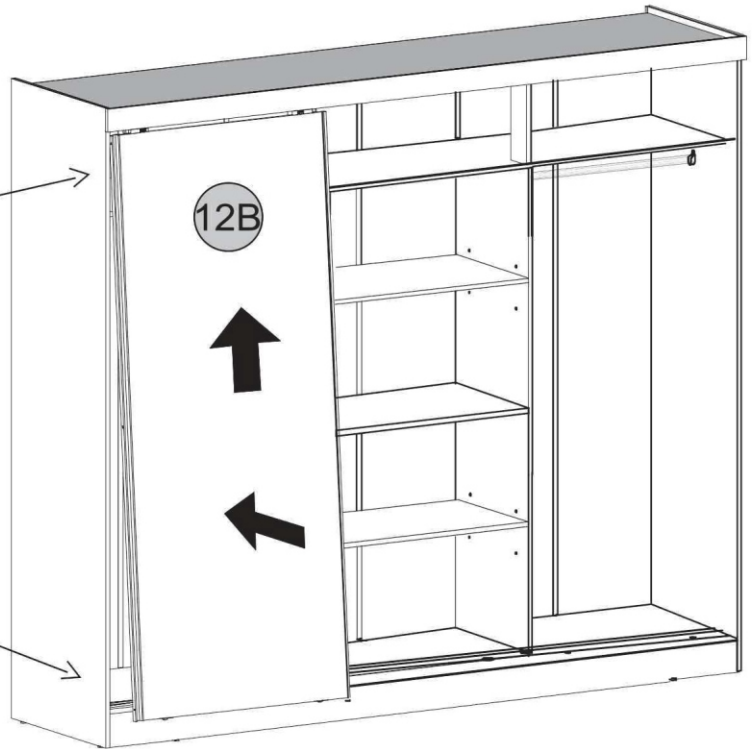

STEP 37

PARTS REQUIRED

12-DOOR x1



HARDWARE REQUIRED

TOOLS REQUIRED

FIT ON BACK RAIL

FIT ON BACK RAIL

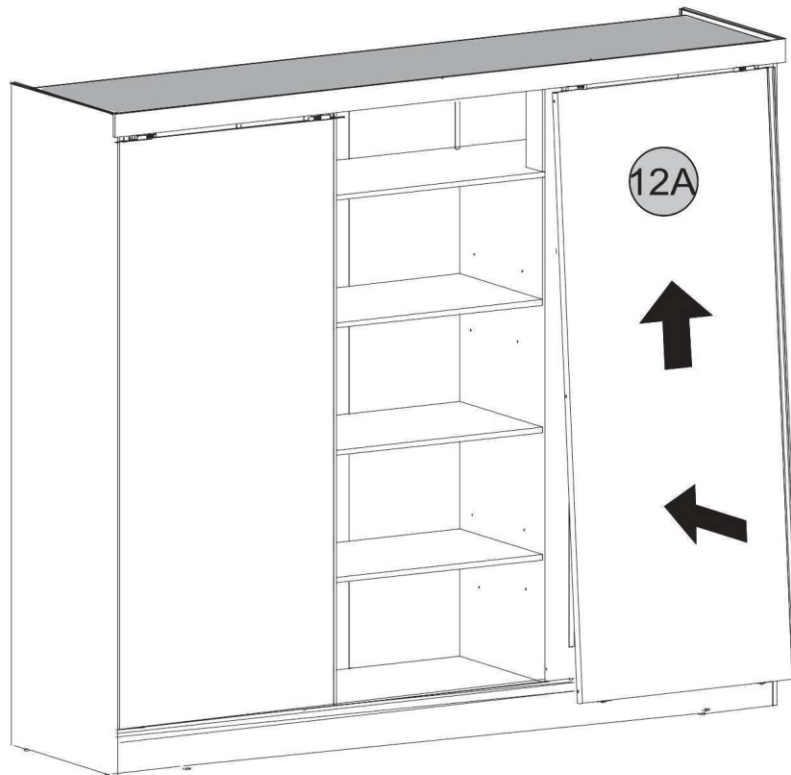

ATTENTION

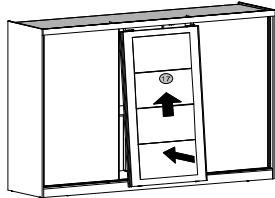

1° Fit the Door

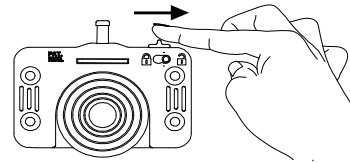

2° Unlock the Pulley

STEP 38

PARTS REQUIRED

17 - MİRRORED DOOR x1

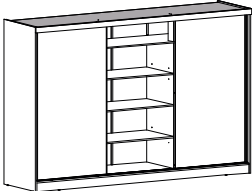

HARDWARE REQUIRED

TOOLS REQUIRED

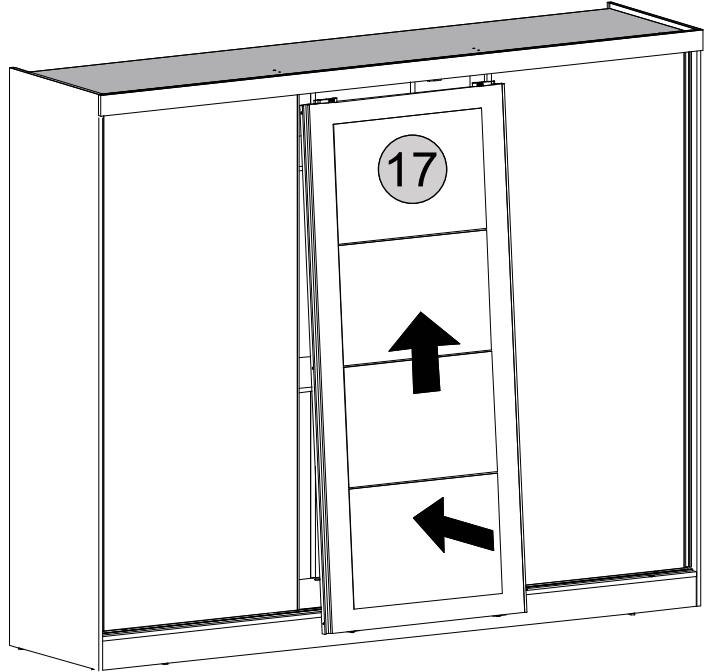
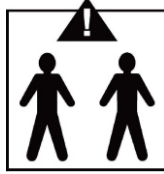

ATTENTION

DOORS ADJUSTMENT

Illustrative Picture

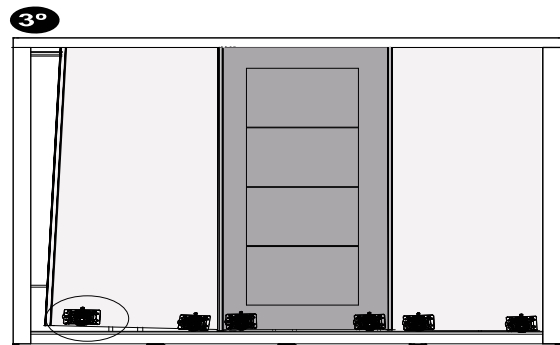
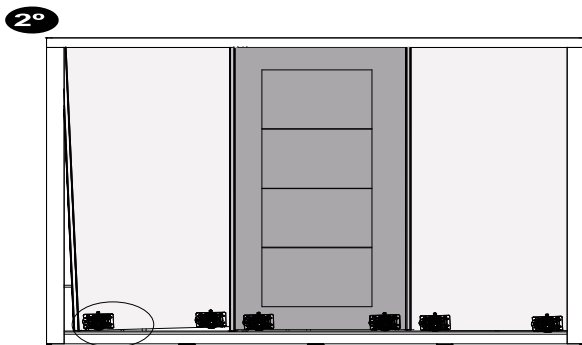
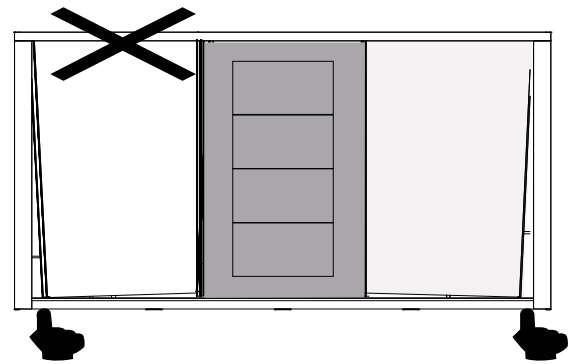
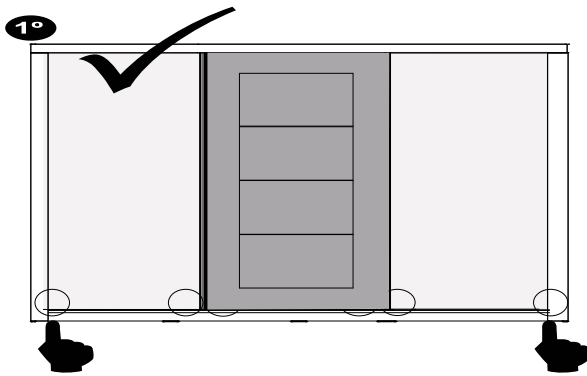

BEFORE REGULATION
UNLOCK THE PULLEY

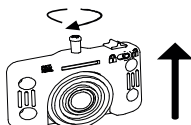

BEFORE REGULATION
UNLOCK THE PULLEY

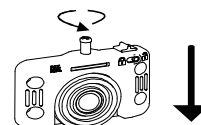

STEP 39

PARTS REQUIRED

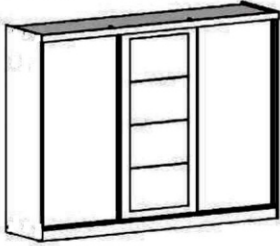

HARDWARE REQUIRED

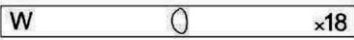

TOOLS REQUIRED

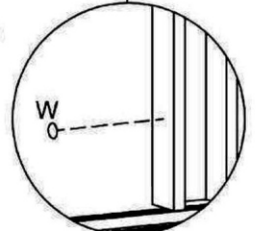
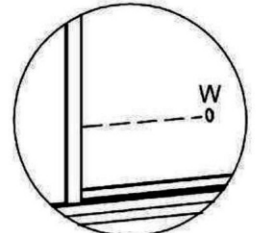
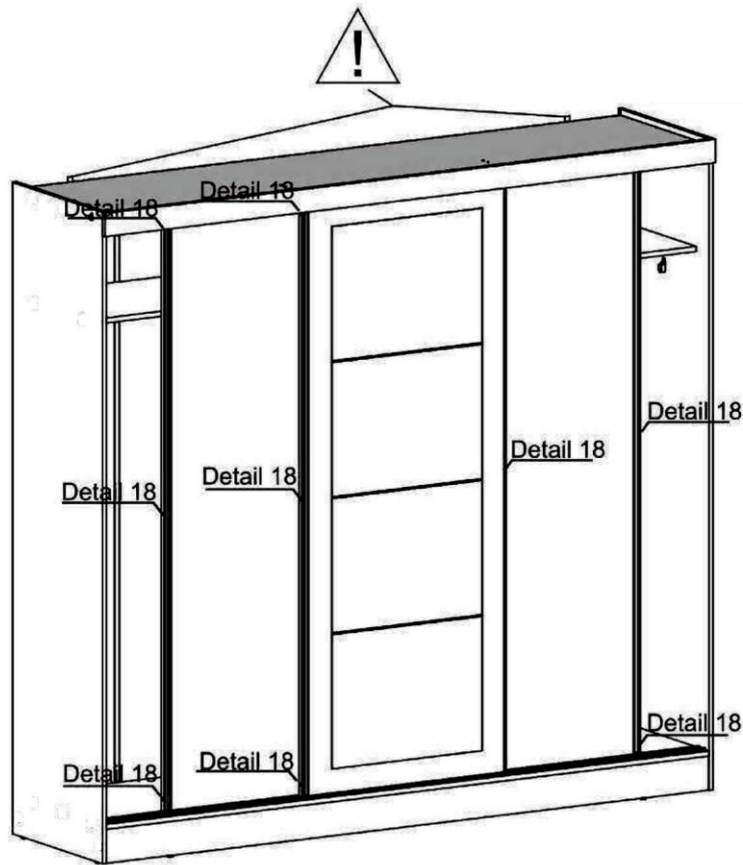

Detail 18

WARNING

Serious or fatal injuries can occur from furniture tipping over. To prevent the furniture from tipping over we recommend that it is permanently fixed to the wall.

Wall fixings are not supplied with this product as different wall materials require different types of fixing devices.

Please make sure you use fixings suitable for the walls in your home.

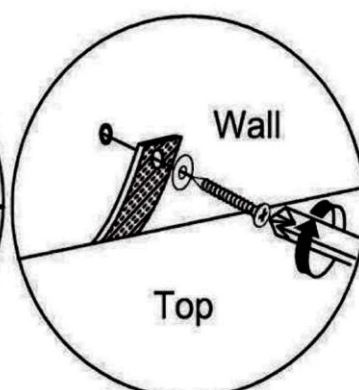
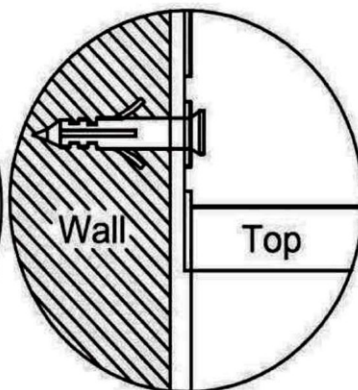
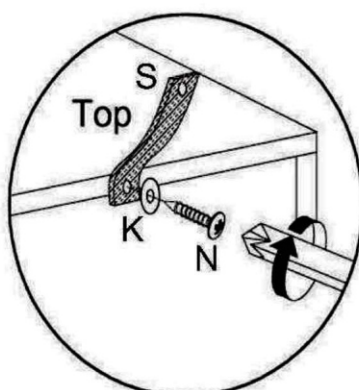

HARDWARE LIST	
S	Strap (Anti-Tip Kit) (2x)
N	Wood Screw (Anti-Tip Kit) 3.5 x 30mm (2x)
K	Washer (Anti-Tip Kit) (4x)