

Birlea

Suppliers of inspiration

Assembly Instructions

Thank you for
purchasing a
Birlea product.

For a chance to win a *Love 2 Shop* voucher simply post a picture of your new product on your preferred social channels tagging Birlea Furniture and using the hashtag **#ShareYourStyle** and **#Birlea**. One winner will be selected at random each month.

To view our full terms and conditions please visit our website. www.birlea.com

Are you happy with your purchase?

Yes: That's great, we would love to hear more from you. Please leave us a review on our social media channels or Trustpilot. Your feedback will be greatly appreciated.

No: If for any reason there is something missing, indifferent or incorrect with your order, please contact the retailer you purchased the item from. We will work with the retailer to resolve your issue as quickly as possible.



www.birlea.com

ASSEMBLY INSTRUCTIONS
HAMPSTEAD 2 DOOR WARDROBE OAK

IMPORTANT : READ THESE INSTRUCTIONS CAREFULLY BEFORE ATTEMPTING TO ASSEMBLE OR USE YOUR HAMPSTEAD 2 DOOR WARDROBE OAK.

PLEASE KEEP THESE INSTRUCTIONS FOR FUTURE REFERENCE.

ASSEMBLY:

Assembly should be carried out with this item laying flat, not standing upright.

Assemble on a soft, clean surface to prevent damages.

To erase the numbers printed on the pieces, use the rubber inside the accessories pack.

HEALTH & SAFETY:

DO NOT use this product if any parts are missing, damaged or worn.

DO NOT use this product unless all fixings are secured.

Always use on a level, even surface.

CARE & MAINTENANCE:

Periodically check all screws & fixings to ensure they are secure.

DO NOT push this product as this will cause damage.

Always lift this product with two people to repositions.

Keep any sharp objects away from this product.

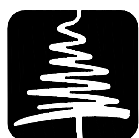
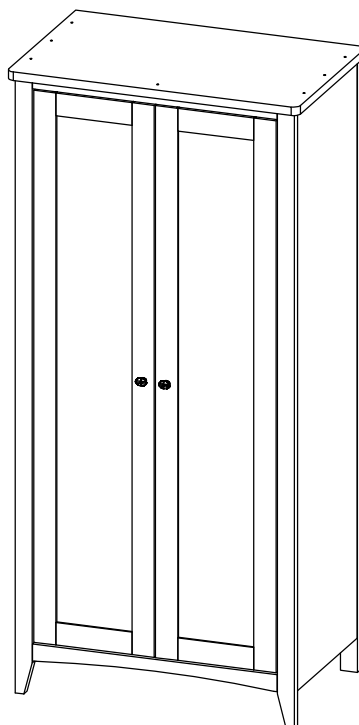

Birlea





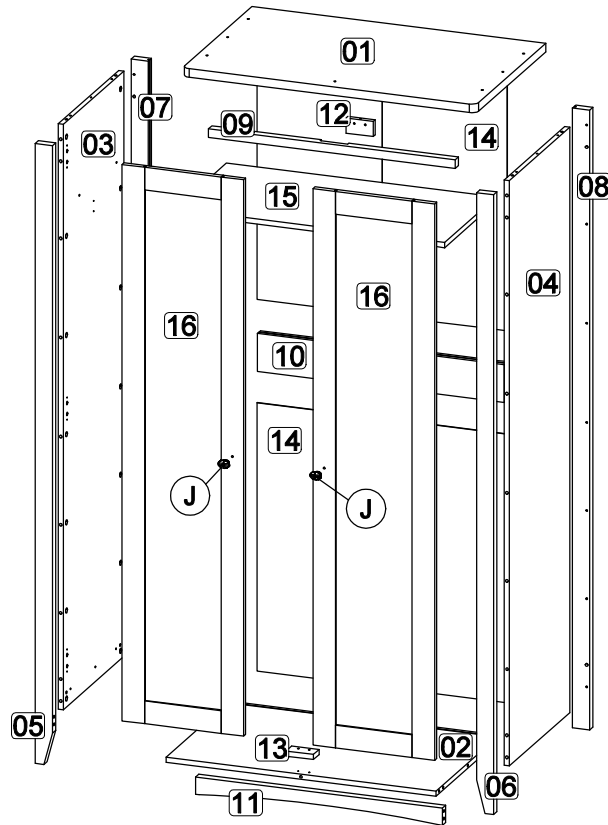









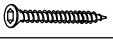





Suppliers of inspiration

www.birlea.com

**Parts List**

Part	Description	Box	Qty
01	Top panel	2	1
02	Bottom panel	2	1
03	Side panel (Left)	1	1
04	Side panel (Right)	1	1
05	Front leg (Left)	1	1
06	Front leg (Right)	1	1
07	Back leg (Left)	1	1
08	Back leg (Right)	1	1
09	Front bar	2	1
10	Back support	2	1
11	Leg panel	2	1
12	Door block (Up)	2	1
13	Door block (Down)	2	1
14	Back panel	1	2
15	Shelf panel	2	1
16	Door panel	1	2

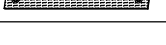
Hardware List (BOX 2)

Part	Description	Qty
A1	Cam lock 	35
A2	Minifix screw 	35
A3	Plastic cap 	35
B	M8 x 30mm Wood Dowel 	24
C	M6 x 60mm CSK Cap Wood screw 	7
D	Allen key M4 	1
E	M3.5 x 16mm C.B Screw 	42
F	M4 x 20mm C.B Screw 	12
G	M4 x 25mm C.B Screw 	4
H	5/8 PVC Nail Leg 	4
I	Handle Screw M4 x 22mm 	2
J	Handle Knob 5166028 SS 	2
K	S125 - Double Hole Fitting 	6
L	Metal shelf support 	4
M	PVC Block 	6
N1	Stud 192 	8
N2	Stud 192 screw 	8
O	7/8 Hinges 	6
P	433 Oval tube bracket 	2
Q	433 Oval pipe 	1
R	8" x 1" PP tape 	2

**** You will need a small mallet and a screwdriver for assembly.**

**** Some screws and wooden dowel may remain.**

**** Note : To secure the item to the wall we recommend you use wall plugs and screw. These are not provided in the fixing kit.**

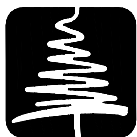

Birlea

Suppliers of inspiration

Step 1: Prepare these parts for assembly using hardware parts A1, A2, B, E, F, M and P.
DO NOT use any power tools as this may damage the frame and will invalidate any claim.

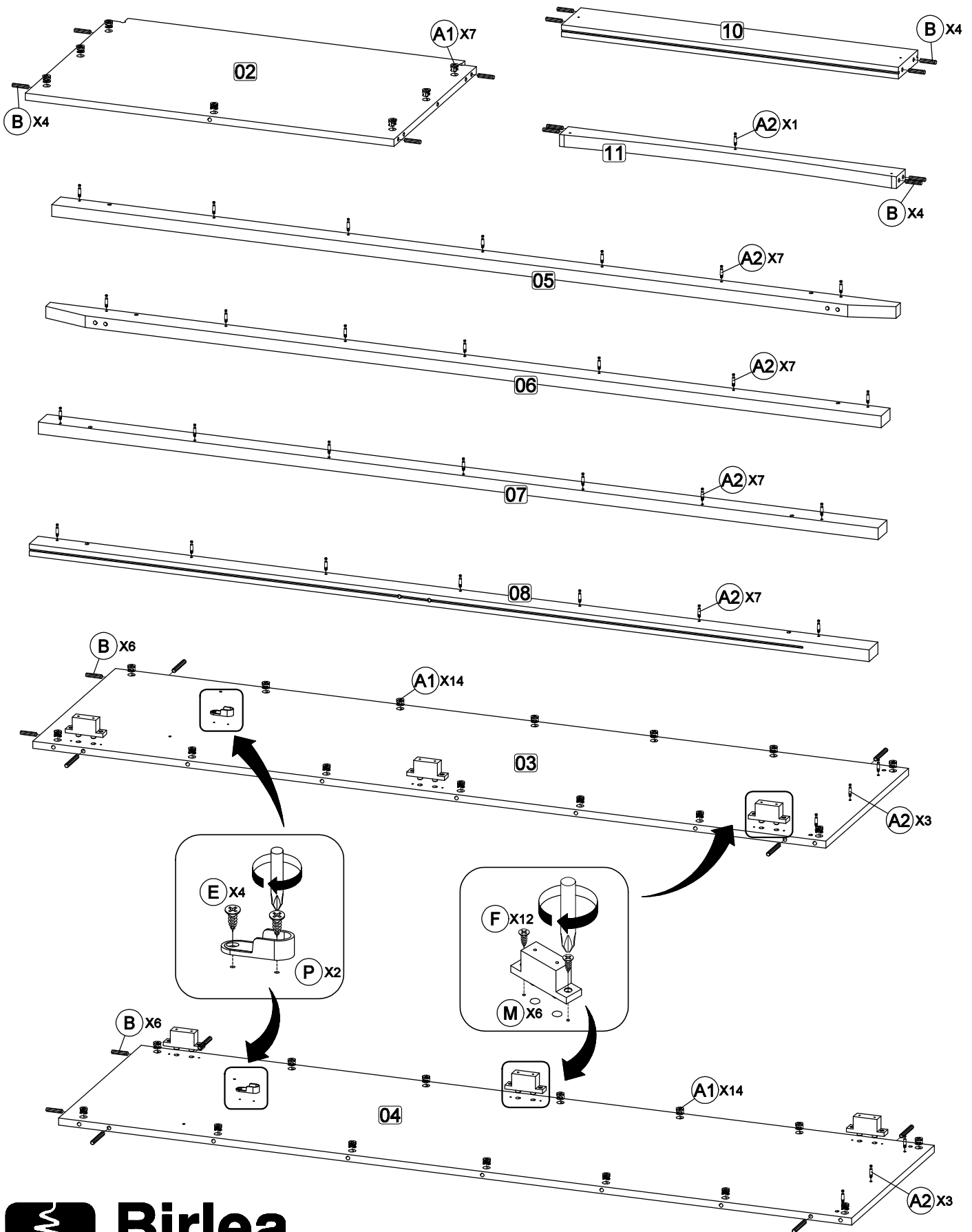

**Step 2: Attach back leg (7) to side panel (3) using hardware A1 and A2 with a screwdriver (not provided).
DO NOT use any power tools as this may damage the frame and will invalidate any claim.**

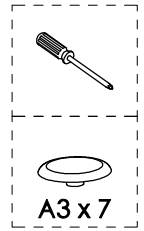
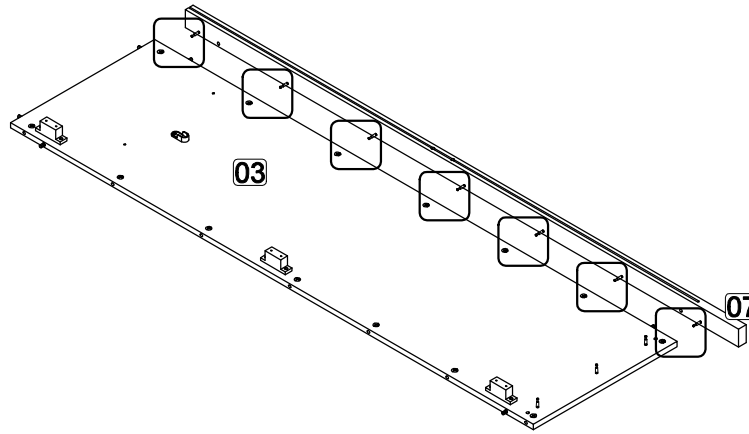
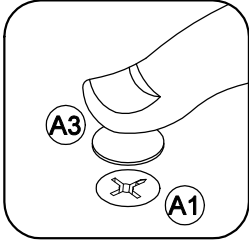
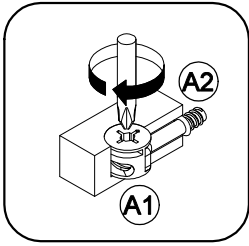

**Step 3: Attach back leg (8) to side panel (4) using hardware A1 and A2 with a screwdriver (not provided).
DO NOT use any power tools as this may damage the frame and will invalidate any claim.**

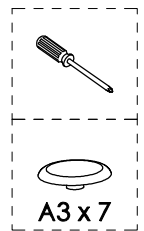
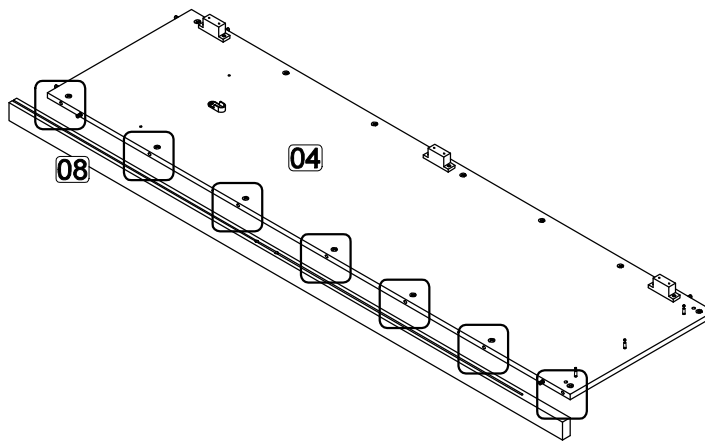
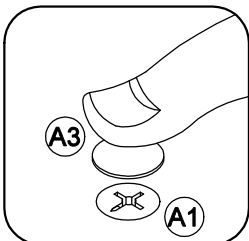
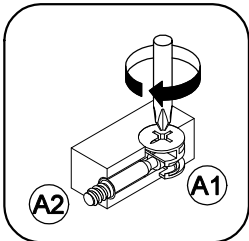

**Step 4: Attach door block (13) to bottom panel (2) using hardware (G) with a screwdriver (not provided).
DO NOT use any power tools as this may damage the frame and will invalidate any claim.**

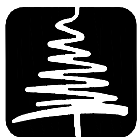
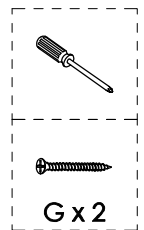
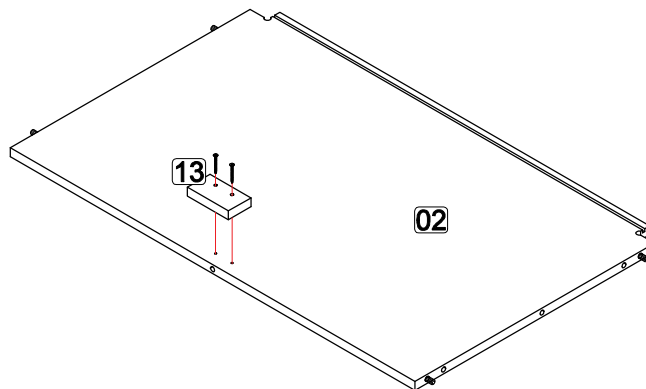
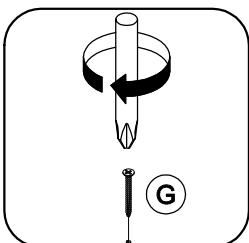

Birlea

Suppliers of inspiration

Step 5: Attach bottom panel (2) and back support (10) to side panel (3) using hardware A1 and A2 with a screwdriver (not provided).

DO NOT use any power tools as this may damage the frame and will invalidate any claim.

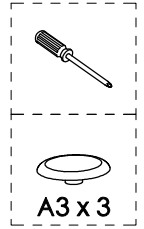
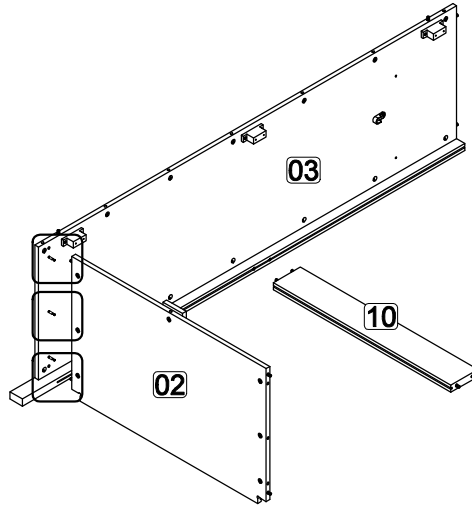
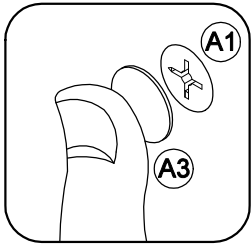
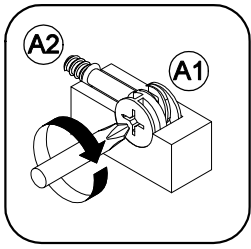

Step 6: Insert back panel (14) along the slot.

DO NOT use any power tools as this may damage the frame and will invalidate any claim.

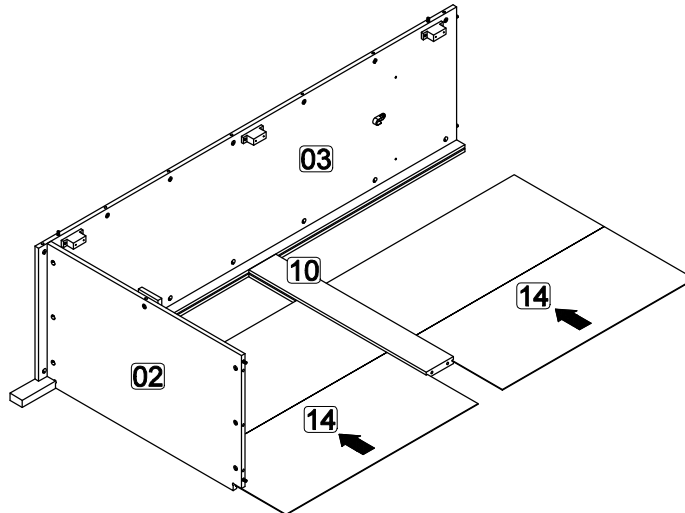

Step 7: Attach side panel (4) to bottom panel (2) and back support (10) using hardware A1 and A2 with a screwdriver (not provided).

DO NOT use any power tools as this may damage the frame and will invalidate any claim.

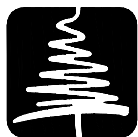
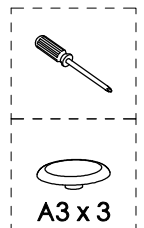
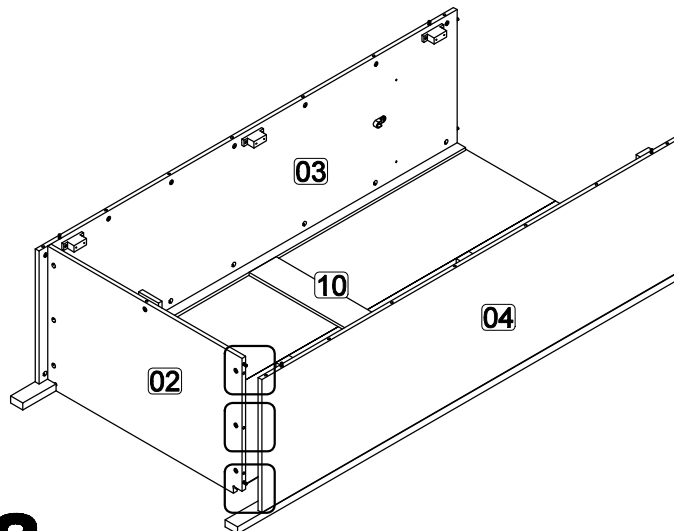
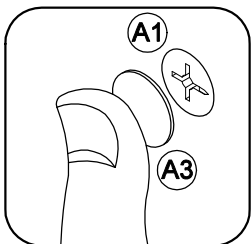
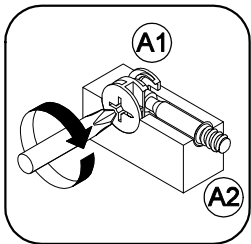

Birlea

Suppliers of inspiration

Step 8: Attach door block (12) to front bar (9) using hardware (G) with a screwdriver (not provided).
DO NOT use any power tools as this may damage the frame and will invalidate any claim.

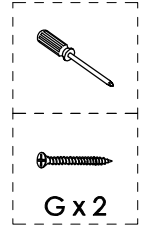
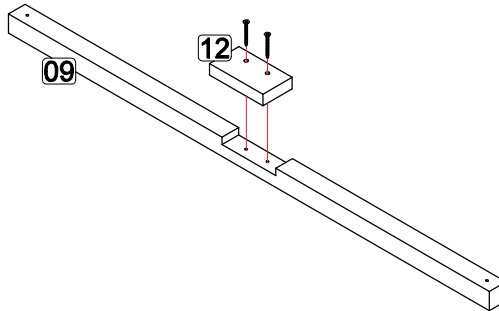
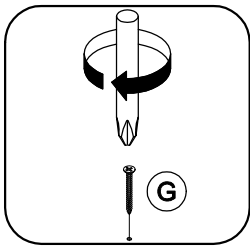

Step 9: Attach front leg (5) and (6) to leg panel (11).
DO NOT use any power tools as this may damage the frame and will invalidate any claim.

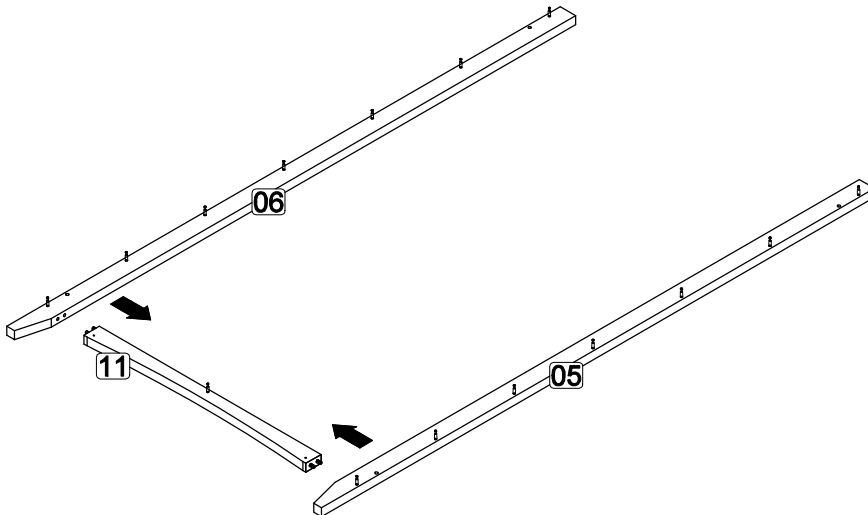

Step 10: Fix hardware K into front leg (5), (6), front bar (9) and leg panel (11) using hardware E with a screwdriver (not provided).
DO NOT use any power tools as this may damage the frame and will invalidate any claim.

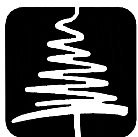
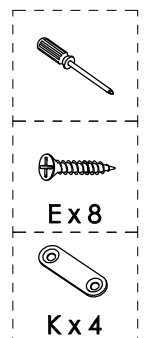
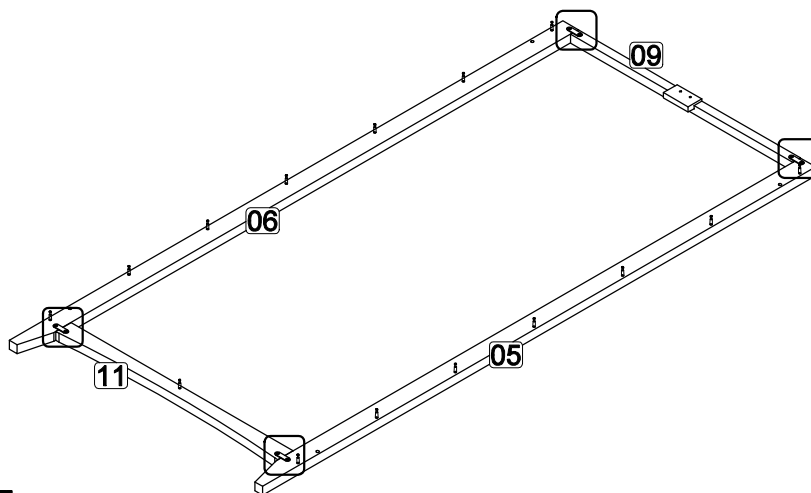
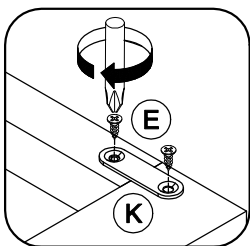

Birlea

Suppliers of inspiration

Step 11: Attach front leg (5), (6) and leg panel (11) to bottom panel (2), side panel (3) and (4) using hardware A1 and A2 with a screwdriver (not provided).

DO NOT use any power tools as this may damage the frame and will invalidate any claim.

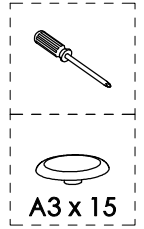
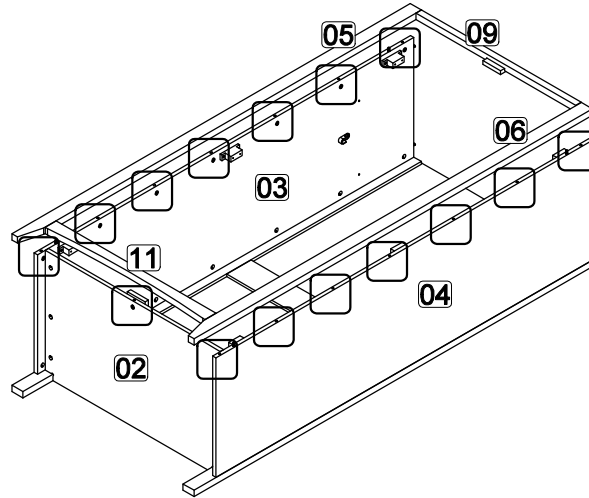
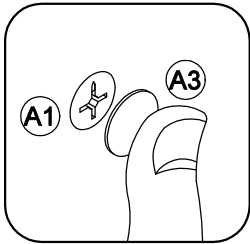
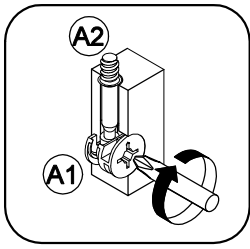

Step 12: Hit hardware H into bottom of front leg (5), (6), back leg (7) and (8).

DO NOT use any power tools as this may damage the frame and will invalidate any claim.

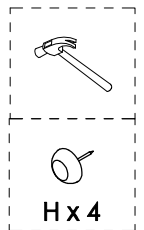
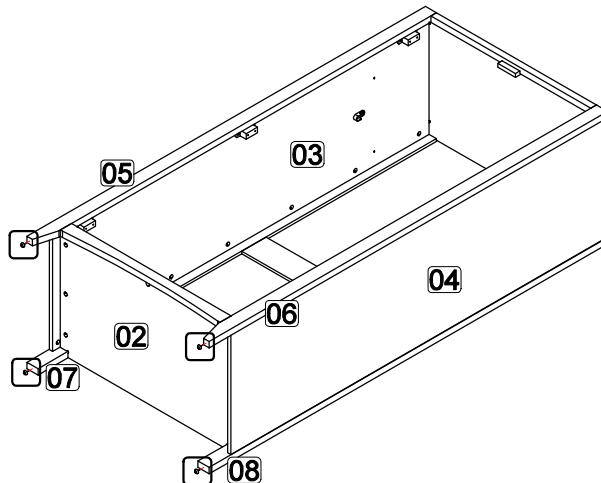
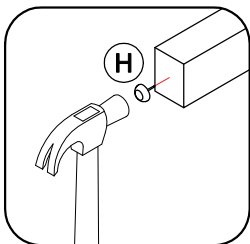

Step 13: Attach top panel (1) to side panel (3), (4) and door block (12) using hardware C and D.

DO NOT use any power tools as this may damage the frame and will invalidate any claim.

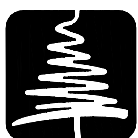
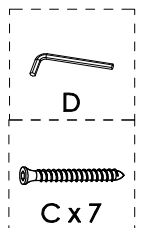
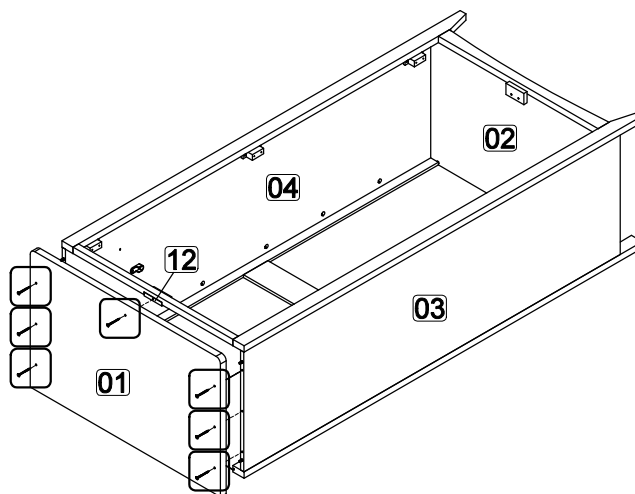
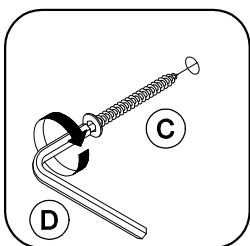

Birlea

Suppliers of inspiration

Step 14: Fix hardware K into back leg (7), (8) and back support (10) using hardware E with a screwdriver (not provided).
DO NOT use any power tools as this may damage the frame and will invalidate any claim.

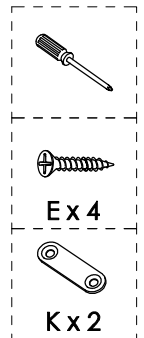
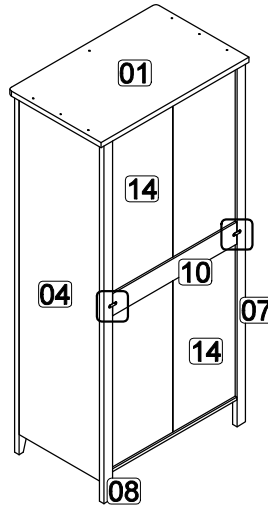
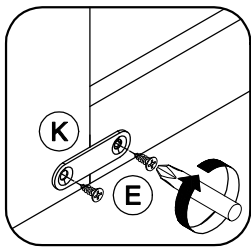

Step 15: Attach hardware N1 into top panel (1), bottom panel (2), back leg (7) and (8) using hardware N2 with a screwdriver (not provided).
DO NOT use any power tools as this may damage the frame and will invalidate any claim.

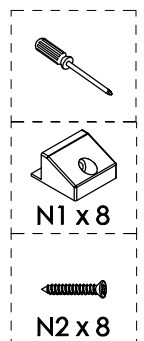
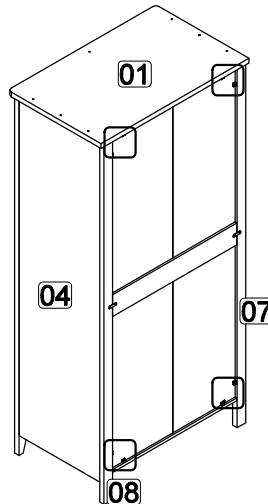
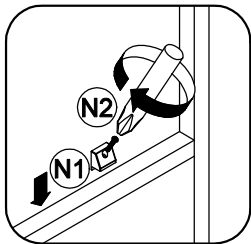

Step 16: Insert hardware L into mounting positions on side panel (3) and (4).
DO NOT use any power tools as this may damage the frame and will invalidate any claim.

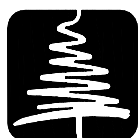
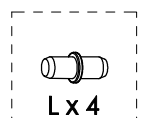
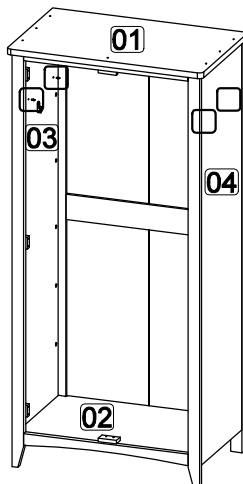
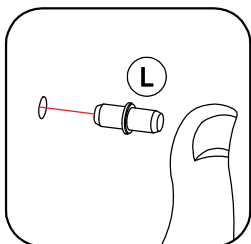

Birlea

Suppliers of inspiration

Step 17: Assemble shelf panel (15) between side panel (3) and (4).

DO NOT use any power tools as this may damage the frame and will invalidate any claim.

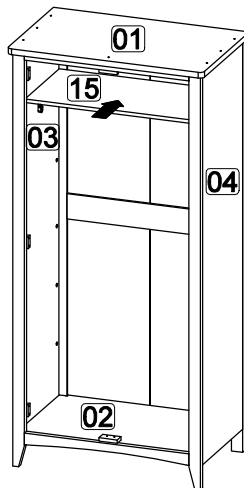

Step 18: Attach hardware Q into hardware P.

DO NOT use any power tools as this may damage the frame and will invalidate any claim.

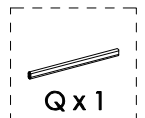
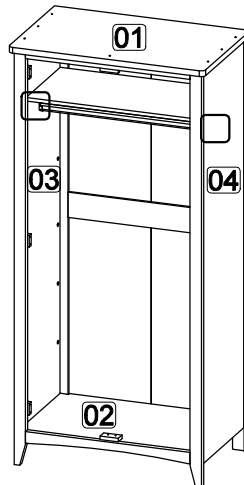
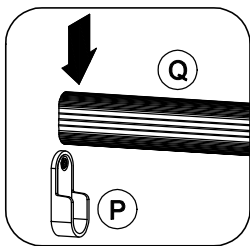

Step 19: Fix hardware O onto door panel (16) by using hardware E.

Fix hardware J onto door panel (16) by using hardware I.

DO NOT use any power tools as this may damage the frame and will invalidate any claim.

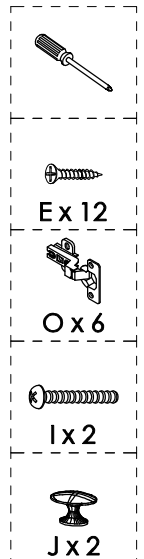
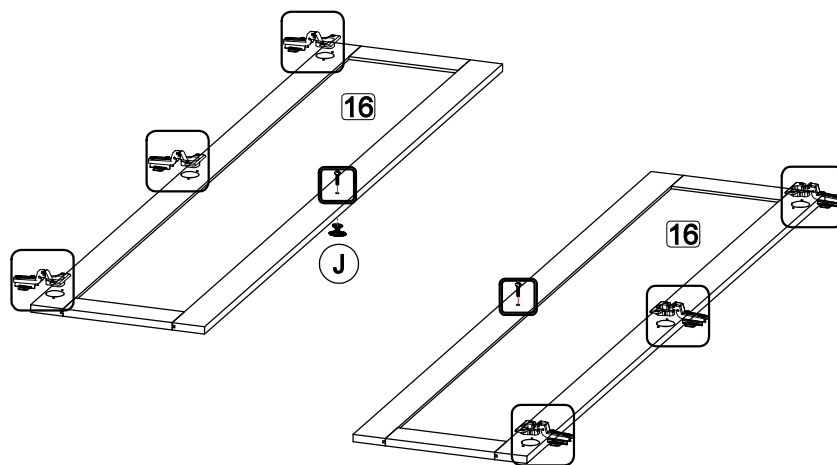
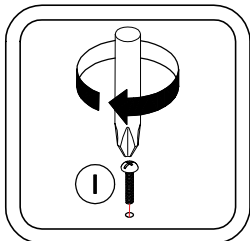
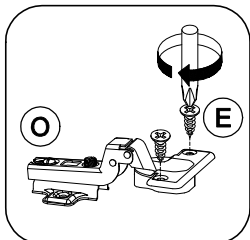

Birlea

Suppliers of inspiration

Step 20: Attach door panel (16) to hardware M using hardware E with a screwdriver (not provided).
DO NOT use any power tools as this may damage the frame and will invalidate any claim.

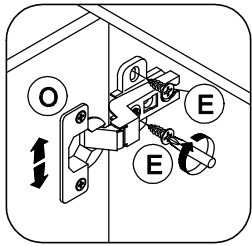

Vertical Adjustment

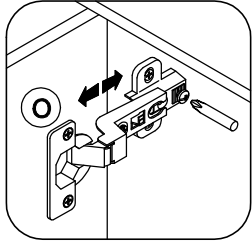

Horizontal Adjustment

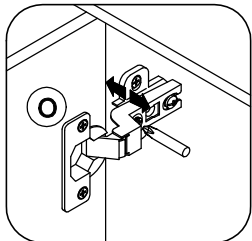

Depth Adjustment

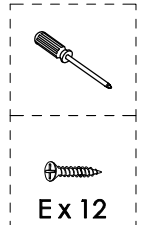
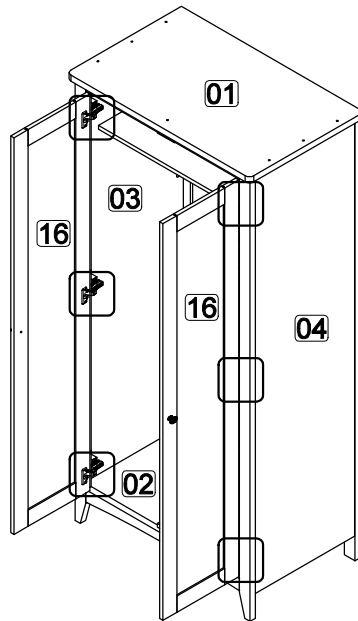

Step 21: To secure the item to the wall use hardware R, screw and wall plug using a screwdriver (not provided).
 Then attach hardware part R to the panel (1) using hardware E with a screwdriver (not provided).
DO NOT use any power tools as this may damage the frame and will invalidate any claim.

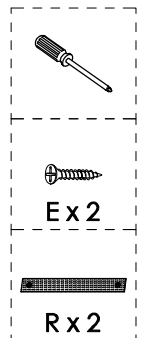
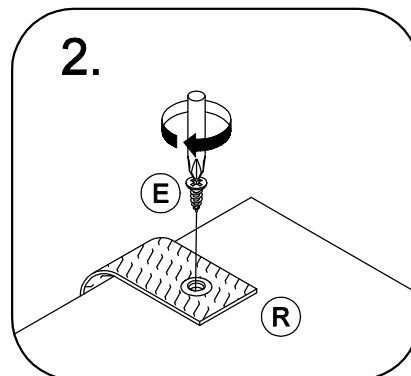
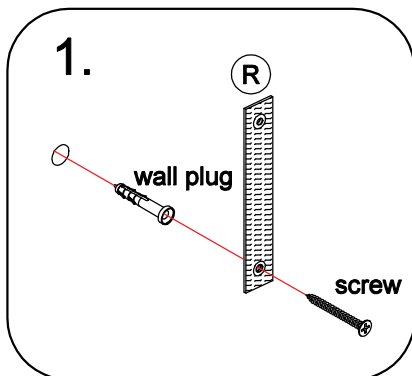

PLEASE NOTE that wall fixings are not supplied as different wall materials require different fixing devices. You must use fixings devices suitable for the type of wall you intend to mount product to. Ensure the head of any screw used has a diameter greater than the mounting hole and the fixing is safe and secure before use.

Birlea Furniture advise you use the hardware R (2 pcs) are provided to further enhance the safety of this product.

Additional Information:

- For complete product information, images and dimension diagrams please visit the website www.birlea.com
- If you have any issues with your item please contact the retailer directly you purchased it from who will be able to resolve any issues with Birlea.
- Why don't you send us photos of your assembled furniture to info@birlea.com to be shared in our #birleahome feature on instagram.

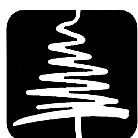

Birlea

Suppliers of inspiration