

TXTB3

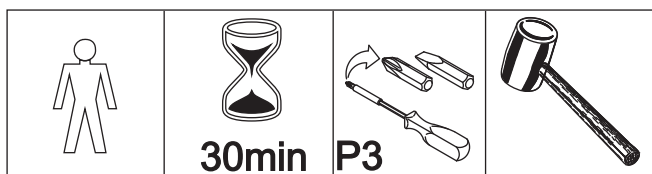

Thank you for choosing this furniture.

BEFORE YOU START ASSEMBLY please store the carton at room temperature for 48 hours or more so the contents can acclimatise.

PLEASE RETAIN ALL PACKING UNTIL YOU HAVE COMPLETED ASSEMBLY.

Information about your Pine furniture.

Our pine furniture ranges have been carefully crafted from solid wood and natural wood veneers. Each piece of pine has unique characteristics such as knots, variances in shading and graining. These are part of the natural character of the furniture itself.

Caring for your Pine furniture.

Extreme temperature can cause slight movements in the wood itself so please avoid placing your furniture close to radiators or other direct sources of heat. Humidity should also be avoided.

Please avoid exposing your furniture to continued bright sunlight as it can affect the colour.

Any fluid spills should be removed as quickly as possible.

Always lift your furniture when moving as dragging may cause damage to your furniture or flooring.

After care.

Wipe the surfaces with a dry cloth and an occasional use of a normal household furniture polish. For the models with drawers, we also recommend you use household spray polish occasionally on drawer grooves and runners as this will aid use. Please do not use detergents or chemicals on your furniture.

PARTS LIST

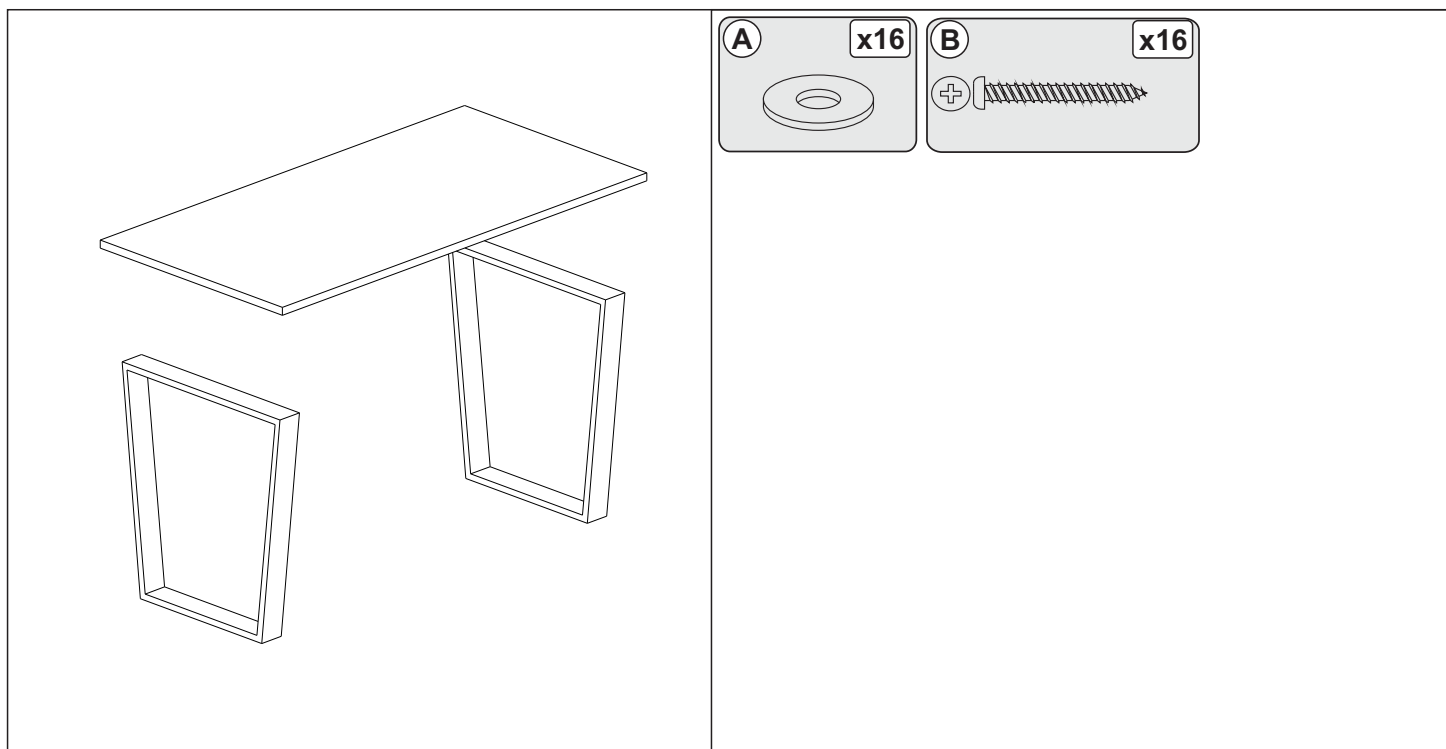

BEFORE YOU START ASSEMBLY

Please check that you have all the correct parts and fittings as detailed on the assembly instructions.

FOR DAMAGED/REPLACEMENT PARTS

Please visit

www.coreproducts.co.uk/parts

Batch
Number

2020-0100

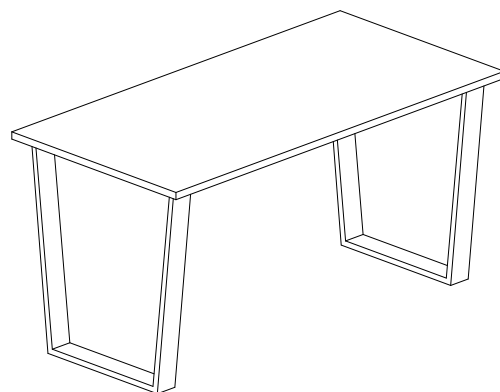

**PLEASE RETAIN THIS LEAFLET ALONG WITH YOUR DELIVERY
NOTE/RECEIPT FOR FUTURE REFERENCE**

