

ASSEMBLY INSTRUCTIONS

STRATUS OTTOMAN 4' BED

IMPORTANT: READ THESE INSTRUCTIONS CAREFULLY BEFORE ATTEMPTING TO ASSEMBLE OR USE YOUR OTTOMAN BED FRAME.

PLEASE KEEP THESE INSTRUCTIONS FOR FUTURE REFERENCE

HEALTH & SAFETY:

DO NOT jump on this bed frame
DO NOT use this bed frame if any parts are missing, damaged or worn
DO NOT use this bed frame unless all fixings are tightly secured
Always use on a level, even surface
Please keep small parts out of reach of children.

WARNING: Take care when assembling the base, assemble the ottoman as close to its final position. The Ottoman has a powerful mechanism and after assembly should only be opened when the mattress is in place.

WARNING: IF THIS BED FRAME IS ON A LAMINATED FLOOR YOU MUST PLACE SOME PROTECTION UNDER ALL LEGS TO STOP THE BED FRAME FROM MOVING. IF THIS IS NOT ADHERED TO THERE IS NO GUARANTEE IF THE BED FRAME COLLAPSES





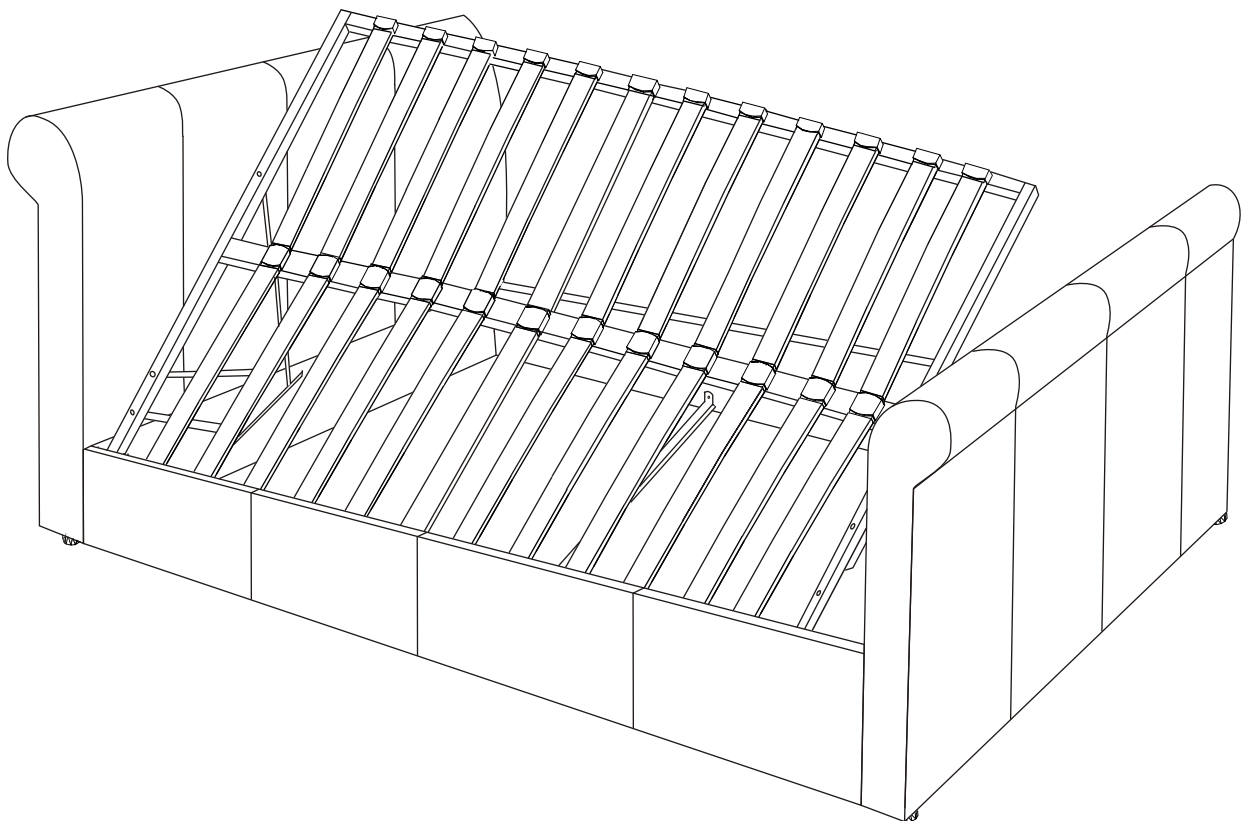









CARE & MAINTENANCE:

Periodically check all screws & fixings to ensure they are tightly secured
DO NOT push the bed frame as this will damage the legs.
Always lift the bed with 2 people whenever you need to change the bed frames position
Keep any sharp objects away from the bed frame



PARTS LIST

HARDWARE LIST

No	Item	Box	Qty	No	Item	Box	Qty
1	Headboard	1	1	A	M5 Allen Key 	1	1
2	Footboard	1	1	B	Bolts (M8x30mm) 	1	8
3	Side Rails	2	2	C	Spring Washer (M8) 	1	14
4	Cross Bar	1	1	D	Flat Washer (M8x22mm) 	1	14
5	Centre Support Bar	2	1	E	Nuts (M8x14mm) 	1	16
6	Legs	1	4	F	Spanner (M14) 	1	1
7	Slats	1	26	G	Bolts (M6x16mm) 	1	2
8	Support Leg	1	1	H	Bolts (M8x45mm) 	1	18
9	Pull Strap	1	1	I	Bolts (M8x65mm) 	1	4
10	Woven Fabric	1	1	J	Bolts (M8x16mm) 	1	4
11	Front Frame Rail	1	1	K	Single Slat Caps 	1	26
12	Back Frame Rail	1	1	L	Centre Slat Caps 	1	13
13	Left Frame Rail	2	1	M	Hydraulic part 	2	2
14	Right Frame Rail	2	1	N	Batten 	1	2
15	Cross Support Bar	1	2	O	M4 Allen Key 	1	1





Step 1

To fix the legs(6) to the headboard(1)and footboard(2).

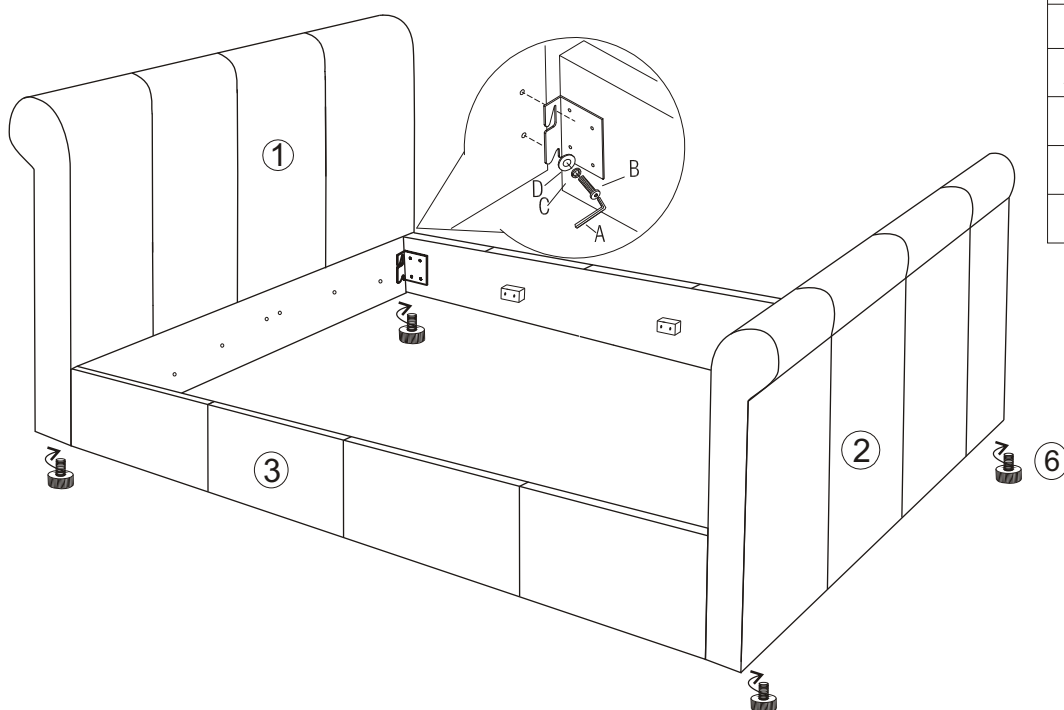
To fix the side rails(3) to the headboard(1) and footboard(2) you will need to use hardware parts (B), (C), (D) with the M5 allen key(A).

**DO NOT USE ANY POWER TOOLS AS THIS MAY DAMAGE THE BED FRAME AND WILL INVALIDATE ANY CLAIMS.
DO NOT FULL TIGHTEN AT THIS STAGE.**



1	Headboard x 1	
2	Footboard x 1	
3	Side rails x 2	
6	Legs x 4	
A	M5 Allen Key	
B	Bolts (M8x30mm) x 8	
C	Spring washer x 8	
D	Flat washer x 8	

MAKE CERTAIN THE BED IS SQUARE AS SHOWN.

Note: THEN tighten all bolts 100% using allen key

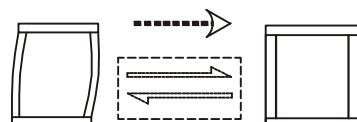









Step 2

To attach the hydraulic part(M) and batten(N) to the headboard(1),footboard(2) you will need to use hardware parts (H) and (C) and (D) with the M5 allen key(A).

To fix the cross bar(4) to the side rails(3)you will need to use hardware parts (G) with (O)

DO NOT USE ANY POWER TOOLS AS THIS MAY DAMAGE THE BED FRAME AND WILL INVALIDATE ANY CLAIMS.

1	Headboard x 1	
2	Footboard x 1	
3	Side rails x 2	
4	Cross Bar x 1	
A	M5 Allen Key	
C	Spring Washer x 6	
D	Flat Washer x 6	
G	Bolts (M6x16mm) x 2	
H	Bolts (M8x45mm) x 6	
M	Hydraulic part x 2	
N	Batten x 2	
O	M4 Allen Key x 1	

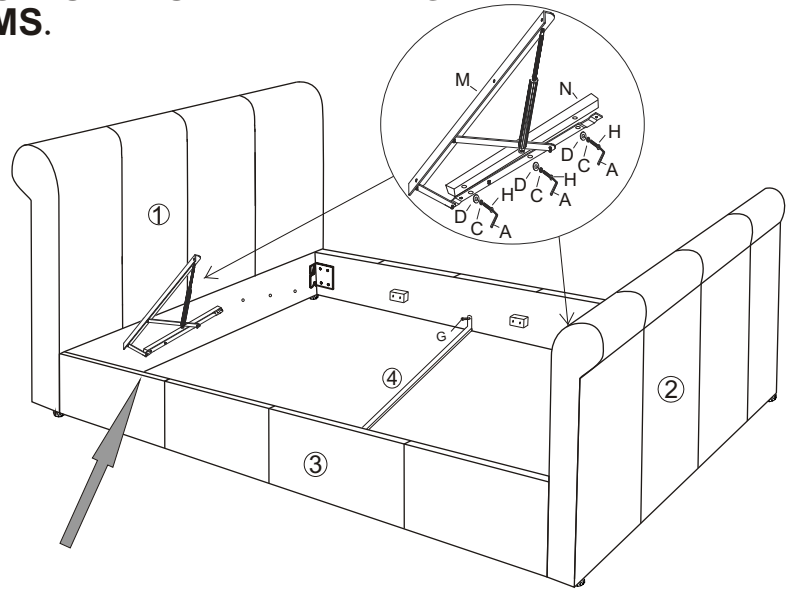

Do not try to press down the gas lift hinge now. It is hard because of the resistance of gas lift struts. Please go to next step to assemble the metal frame.





Step 3

To attach the front frame rail(11)and back frame rail (12) to the left frame rail (13) and right frame rail(14), you will need hardware parts (J) with the M5 allen key(A).

To attach the centre support bar(5) to the front frame rail(11)and back frame rail(12), you will need hardware parts (H) and (E) with the M5 allen key(A) and the spanner(F).

To attach the support leg (8) to the centre support bar(5),you will need hardware parts (H) and (E) with the M5 allen key(A) and the spanner(F).

DO NOT USE ANY POWER TOOLS AS THIS MAY DAMAGE THE BED FRAME AND WILL INVALIDATE ANY CLAIMS.



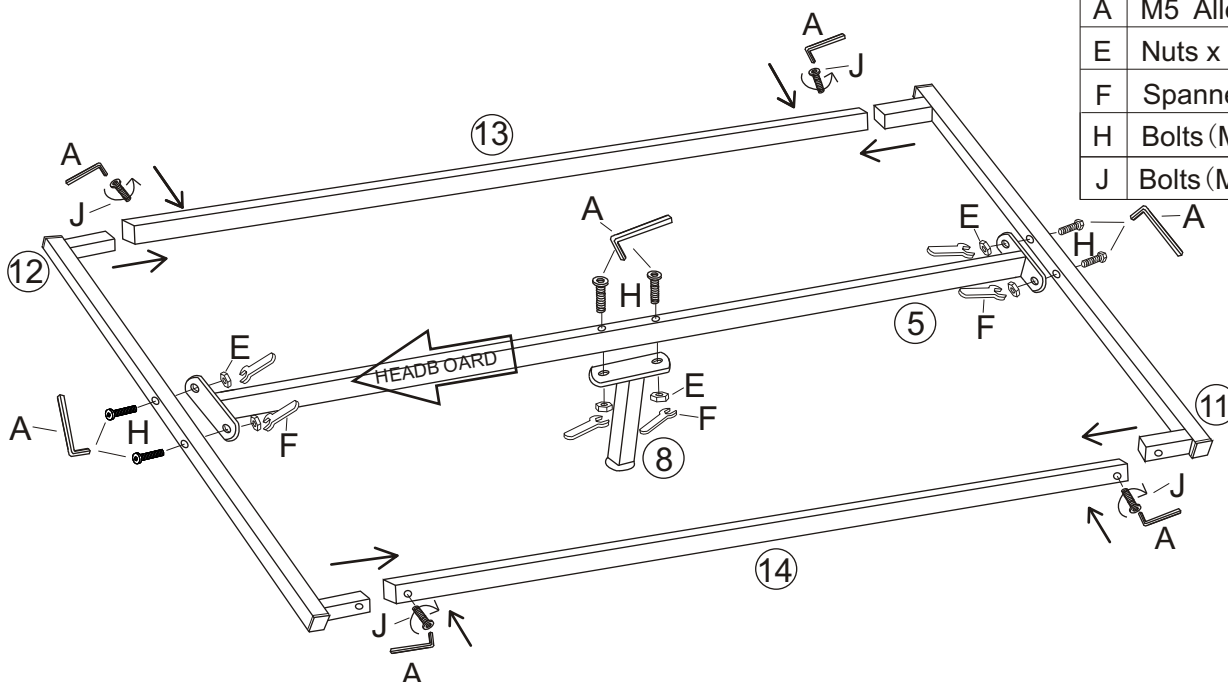

5	Centre Support Bar x 1	
8	Support Leg x 1	
11	Front Frame Rail x 1	
12	Back Frame Rail x 1	
13	Left Frame Rail x 1	
14	Right Frame Rail x 1	
A	M5 Allen Key x1	
E	Nuts x 6	
F	Spanner x 1	
H	Bolts (M8x45mm) x 6	
J	Bolts (M8x16mm) x 4	



Step 4

To attach the metal frame(11/12/13/14) to the hydraulic parts(M), you will need to use hardware parts (H)、(E) with the M5 allen key(A) and the M14 spanner(F). To attach the cross support bar(15) to the left frame rail(13) and the right frame rail(14),you will need, you will need to use hardware parts (I)、(E) with the M5 allen key(A) and the M14 spanner(F).

DO NOT USE ANY POWER TOOLS AS THIS MAY DAMAGE THE BED FRAME AND WILL INVALIDATE ANY CLAIMS.

15	Cross Support Bar x2	
A	M5 Allen Key	
E	Nuts x 10	
F	Spanner	
H	Bolts (M8x45mm) x 6	
I	Bolts (M8x65mm) x 4	

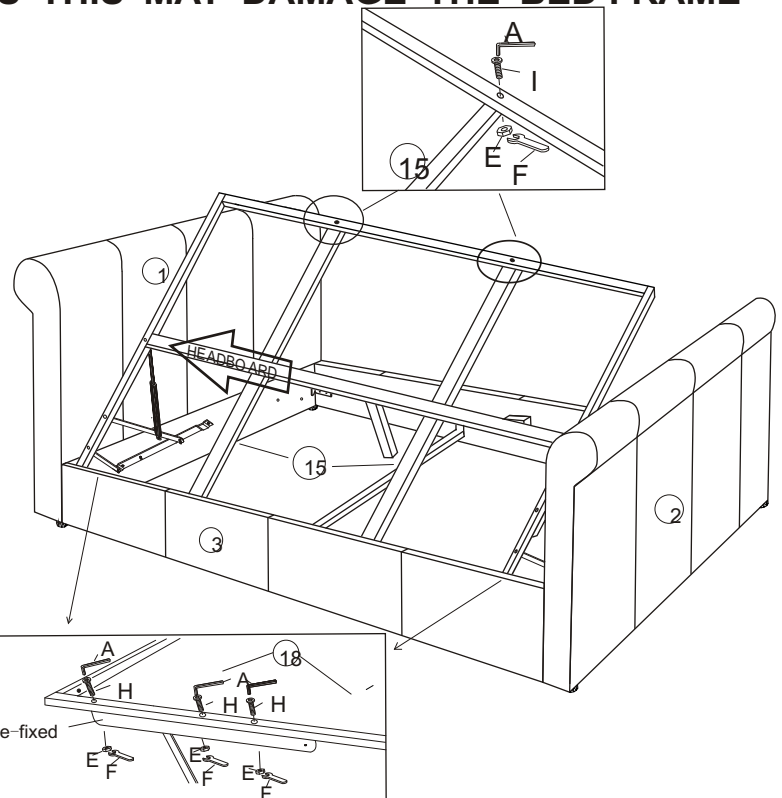

Step 5

To assemble the slats(7) place a single plastic caps(K) onto each end of every slat then need push the centre slat caps(L) into the metal frame.

To attach the pull strap(9) to the left or right frame rail (13/14) you will place the pull strap(9) beneath the metal frame and then pull the strap on the inner side of the frame through the strap on the outer side of the frame to form a knot.

Tilt the bedframe on to its side and attach the fabric base(10.)

DO NOT USE ANY POWER TOOLS AS THIS MAY DAMAGE THE BED FRAME AND WILL INVALIDATE ANY CLAIMS.

7	Slats x 26
9	Pull Strap x 1
10	Woven Fabric x1
K	Single Slat Caps x 26
L	Centre Slat Caps x13

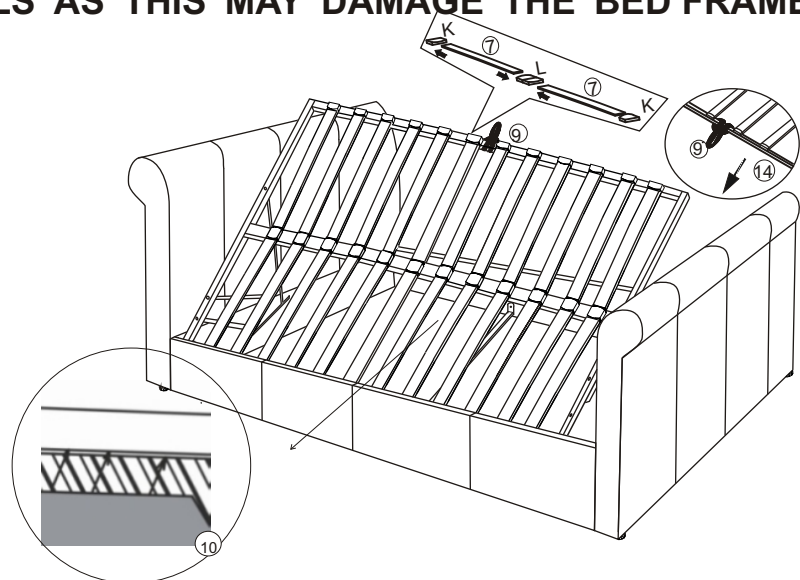

Additional information :

- For complete product information , images and dimension diagrams please visit the website www.birlea.com
- If you have any issues with your item please contact the retailer directly you purchased it from who will be able to resolve any issues with Birlea.
- Why don't you send us photos of your assembled furniture to info@birlea.com to be shared in our #birleahome feature on instagram.