

51956

MONACO 4' HIGH END BED

ASSEMBLY INSTRUCTIONS

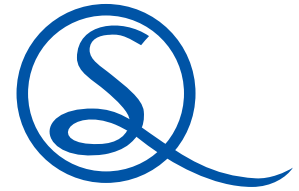
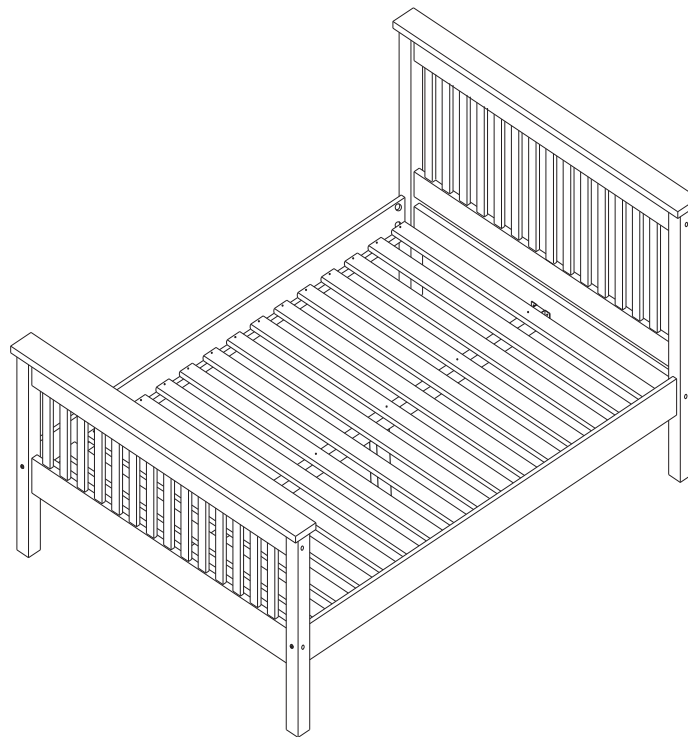

IMPORTANT FOR DOMESTIC USE ONLY

PLEASE READ BEFORE YOU CONTINUE FURTHER

CARE AND MAINTENANCE

- After unpacking this product please keep the original packaging in case it needs to be returned for any reason.
- Please ensure all fittings and parts are present before commencing with assembly.
- We recommend that you lay a blanket or sheet on the floor to avoid damage to both your floor and the product.
- We strongly recommend that you keep children away from your work area.
- Assemble this product as close to its final position as possible.
- Never drag or push products as this could cause damage to the joints making it inferior.
- Do not drag or push items across your furniture as this may cause the surface to scratch.
- Do not place this product next to a radiator or in direct sunlight.
- Wood is a natural product and may expand if subjected to damp and may shrink or crack if subjected to heat. Therefore it is recommended that room temperature is maintained, with no sudden temperature fluctuations.
- Make sure any spillage is wiped off immediately.
- Do not place hot or chilled items directly on to the surface, use a place mat or marking will occur.
- For general cleaning use a soft cotton or micro fibre cloth, and do not use detergents of any kind.
- Do not place on a wet or damp floor as staining may occur to your floor.
- From time to time it may be necessary to tighten fittings, regular inspections should be carried out.

The **RED** colour indicates the **left** component

RED

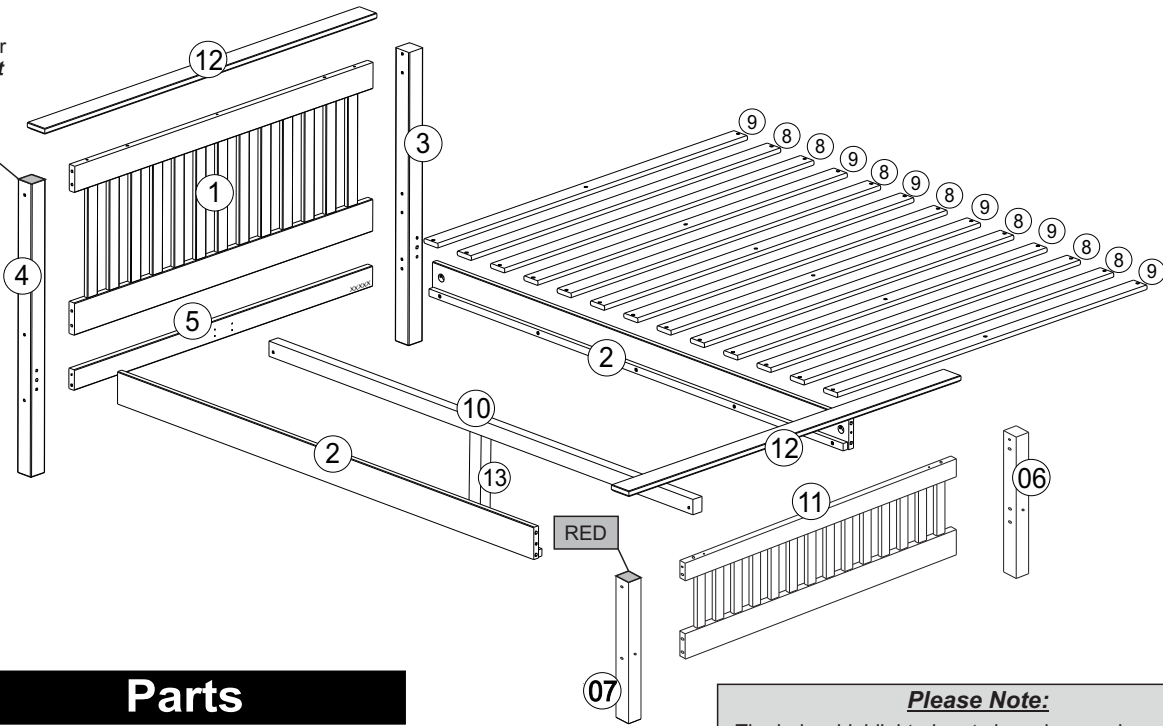

Parts

Please Note:
The below highlighted parts have been colour coded to help identify them during assembly.

1	Headboard panel	01
2	Siderail	02
3	Headboard right post	01
4	Headboard left post (red)	01
5	Headboard crossbeam	01
6	Footboard right post	01
7	Footboard left post (red)	01

8	Slats (2 holes)	07
9	Slats (3 holes)	06
10	Centre Rail	01
11	Footboard panel	01
12	Top crossbeam	02
13	Centre Support Leg	01

!
*Use of power tools to assemble this product will invalidate any claim and could damage this product making it unsafe!!!
*Please assemble on a clean soft surface to avoid damage.

!
*Please check contents and read the instructions before commencing assembly.
*Assemble this product following the enclosed instructions carefully.
*Please take care to avoid damaging parts during assembly.

Fittings

A		22
B		04
C		04
D		10
E		32
F		01
G		02

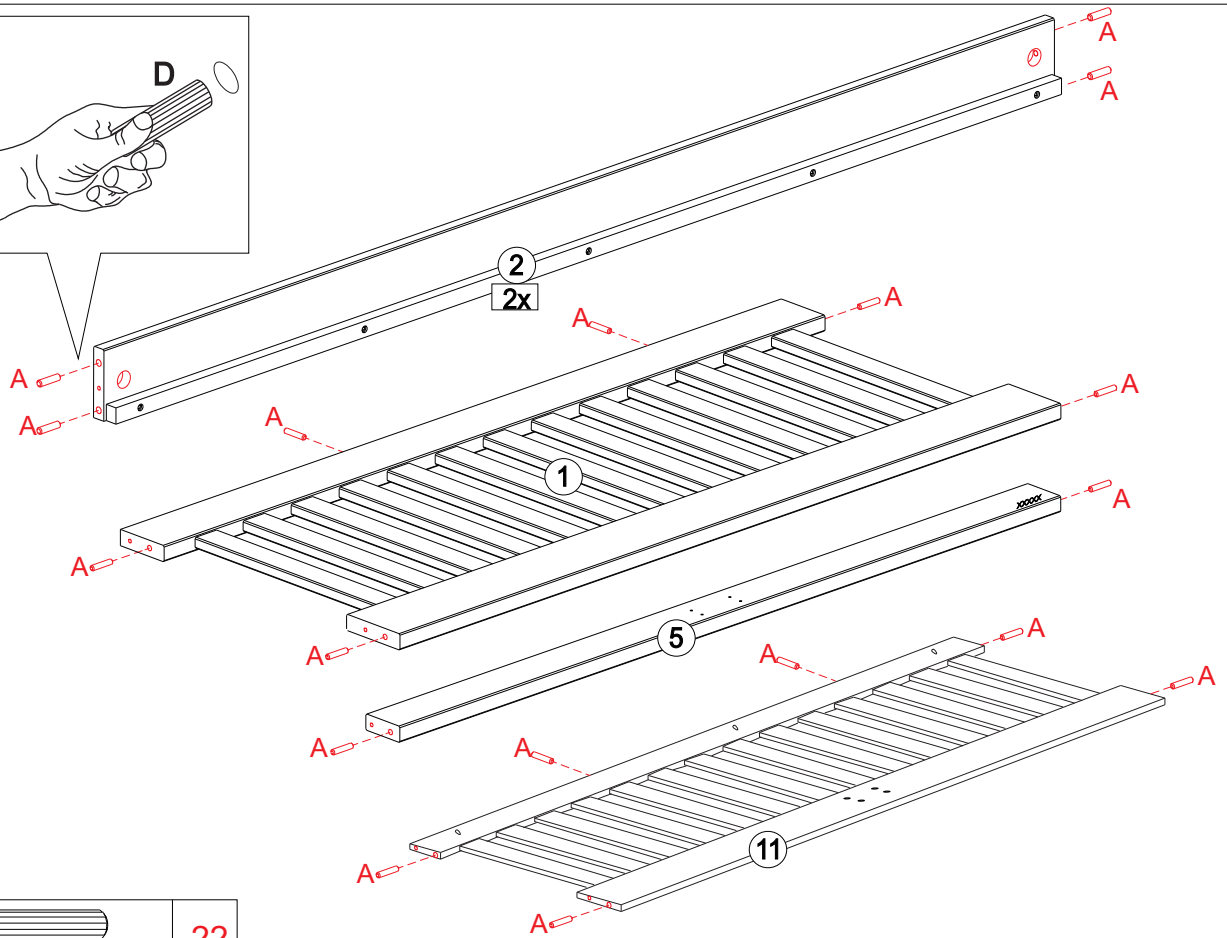
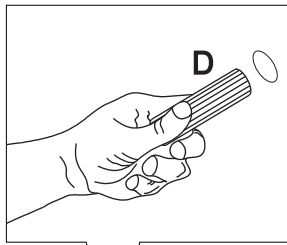

H		08
I		02
J		02
K		02
L		06
M		01

1



A		22
---	--	----

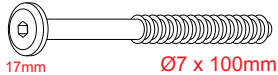

2

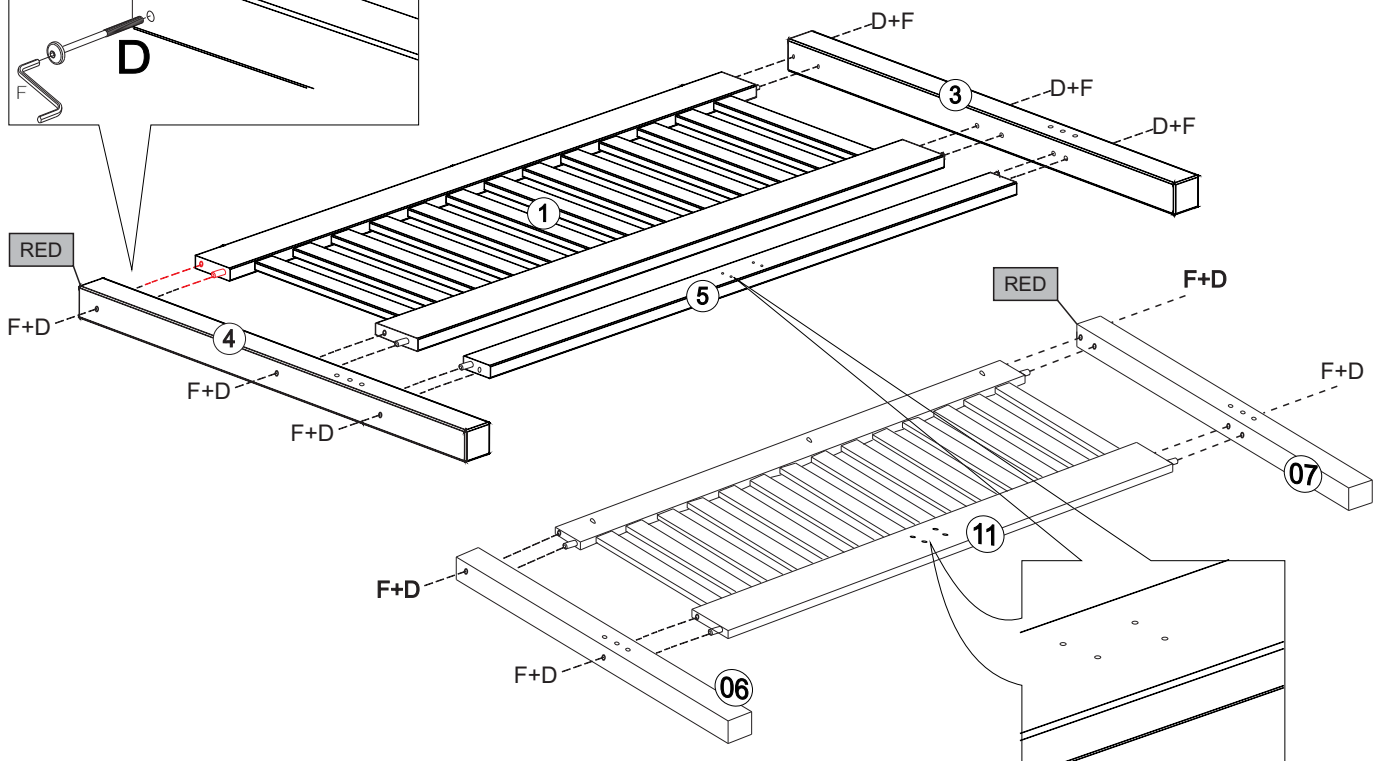
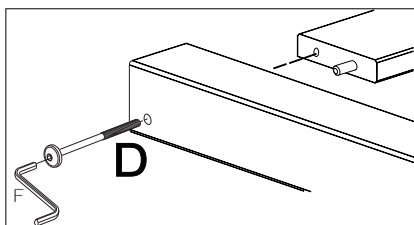
D		10
F		01



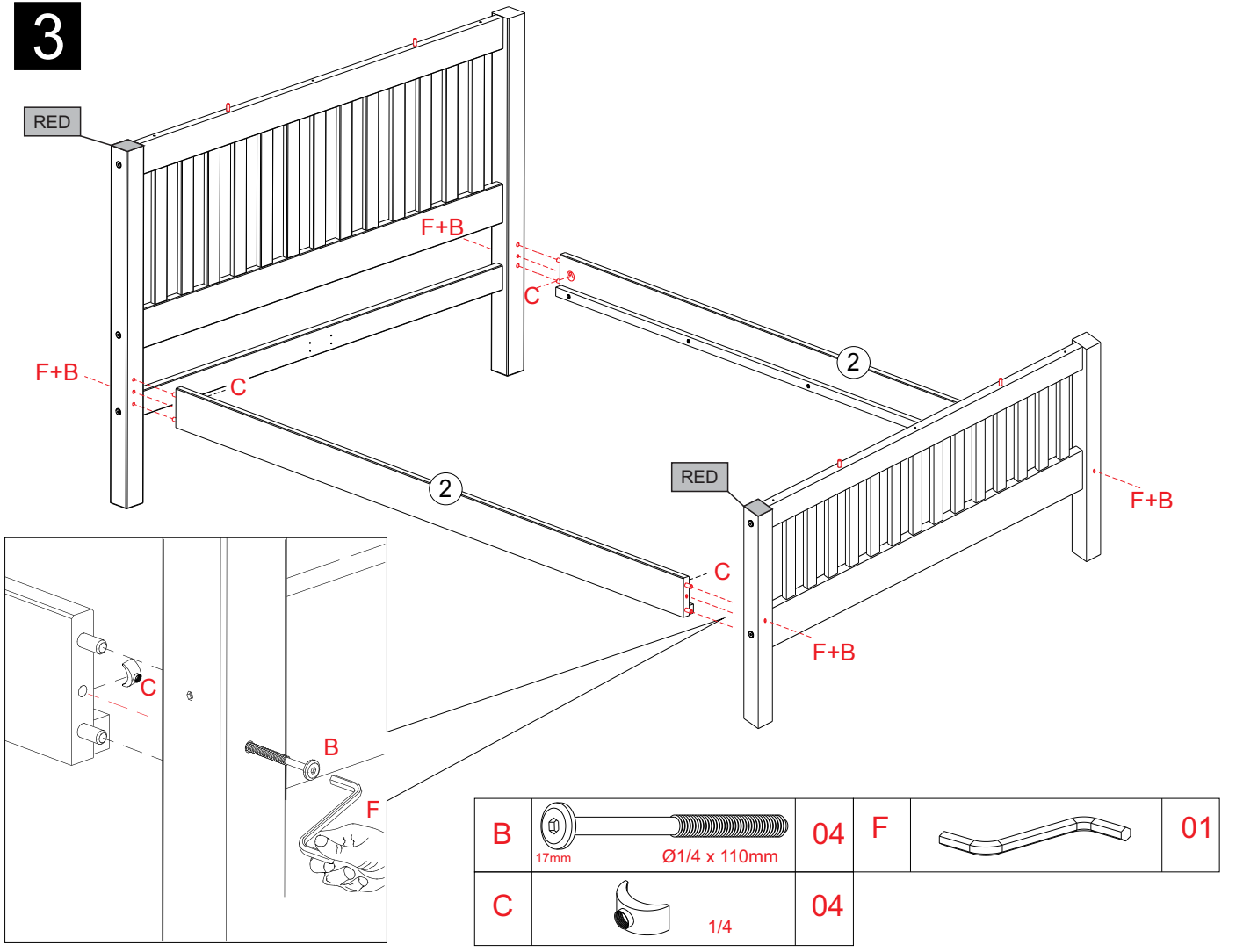

3



B		17mm	Ø1/4 x 110mm	04	F		01
C			1/4	04			

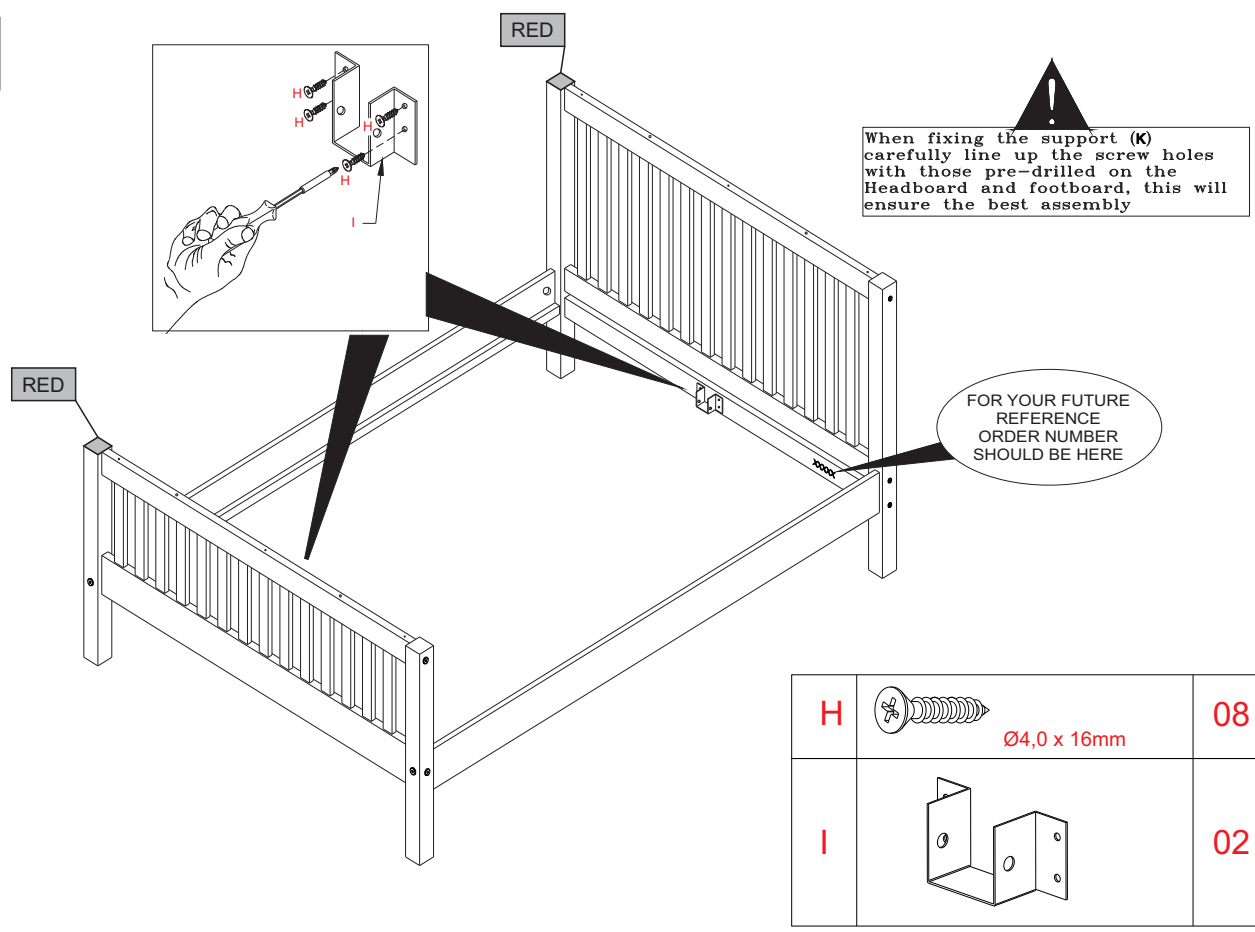

4

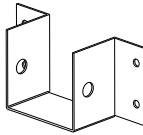

H			Ø4,0 x 16mm	08			
I							02

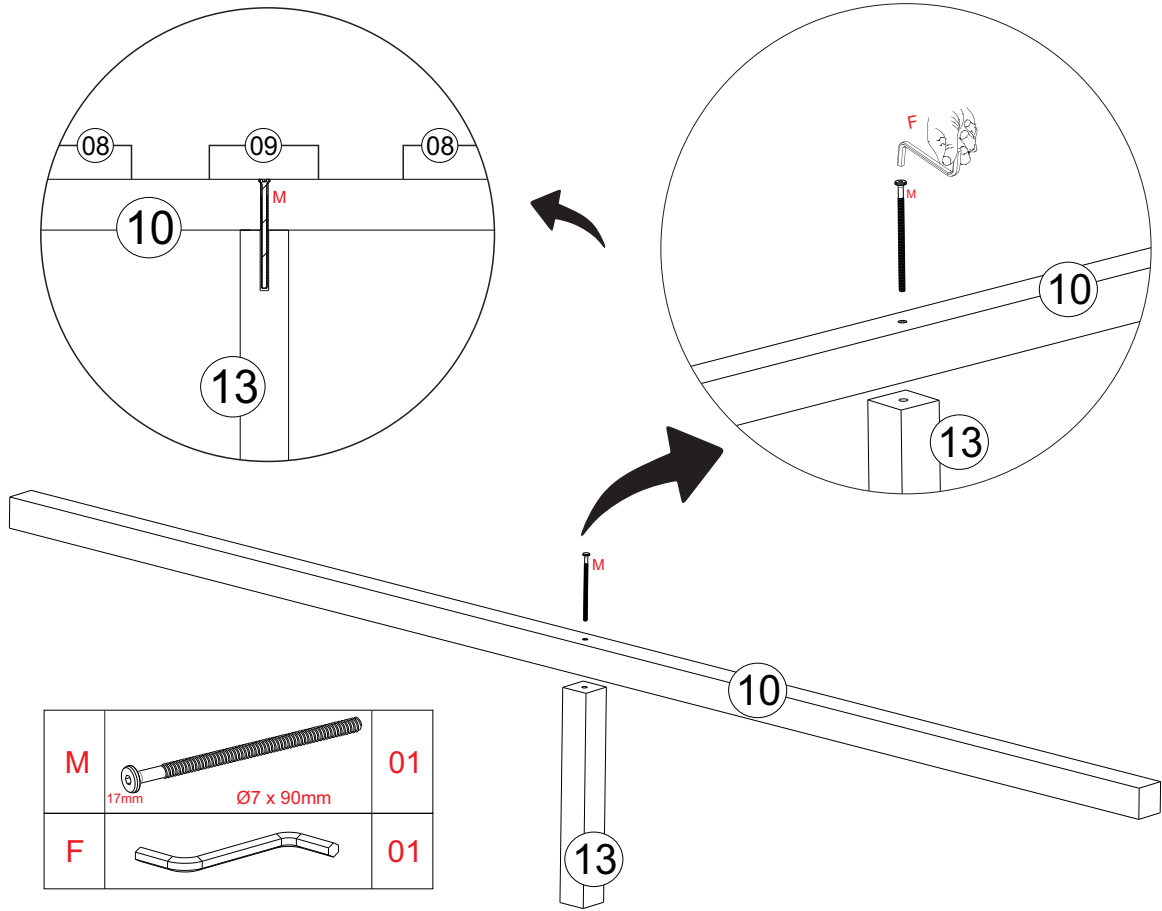
5





M		01
F		01

17mm Ø7 x 90mm

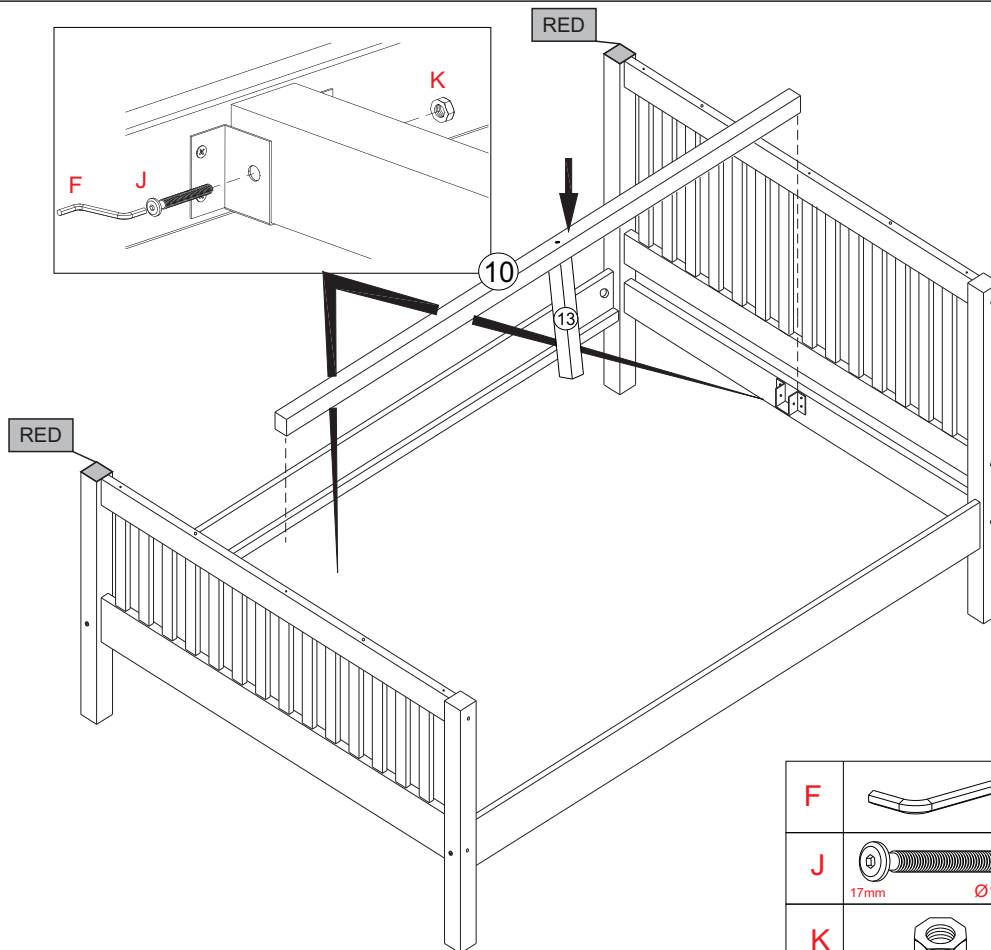
6



F		01
J		02
K		02

17mm Ø1/4 x 60mm 1/4



The use of power tools to assemble this product will invalidate any claim and may damage this product making it unsafe!!!

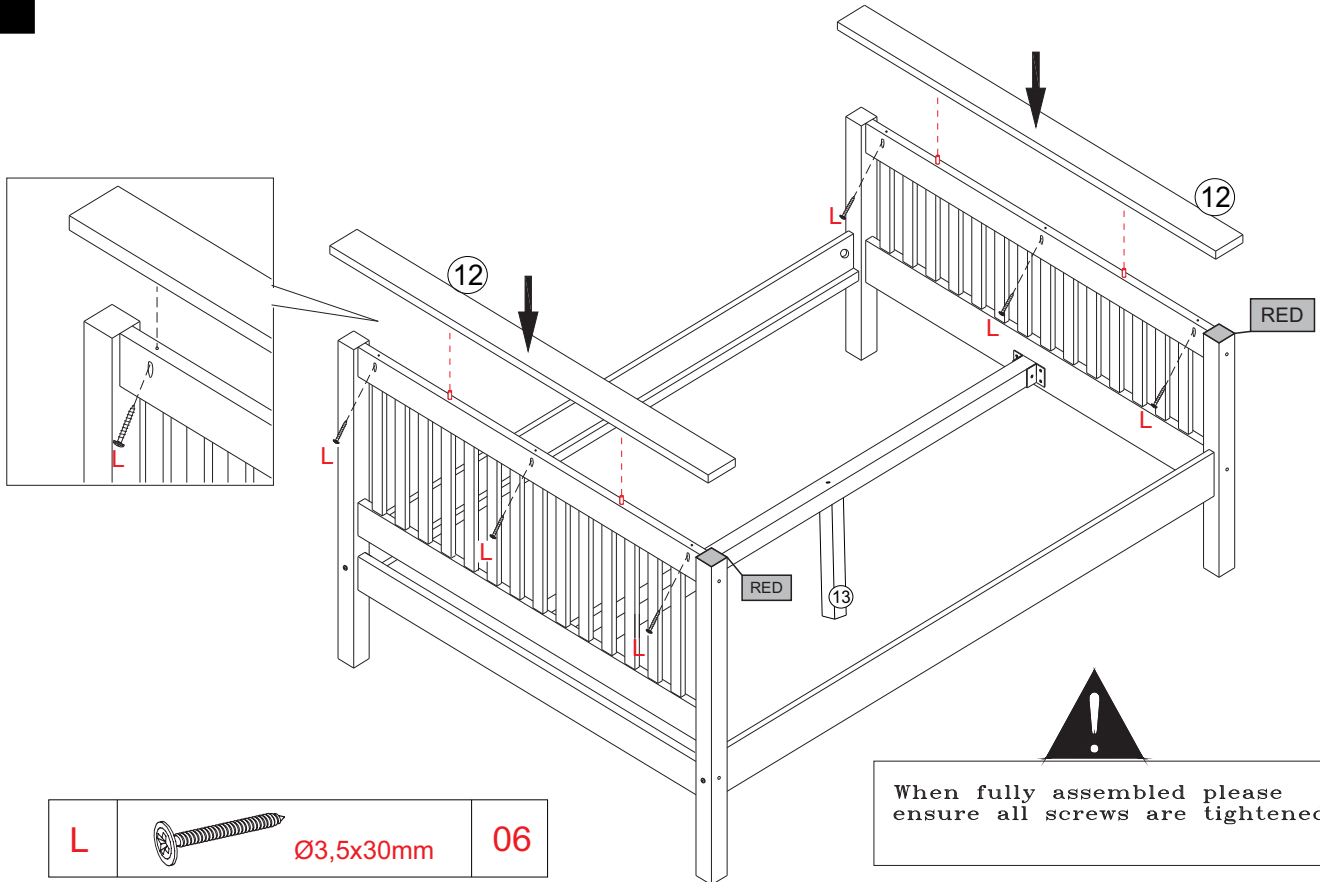

7

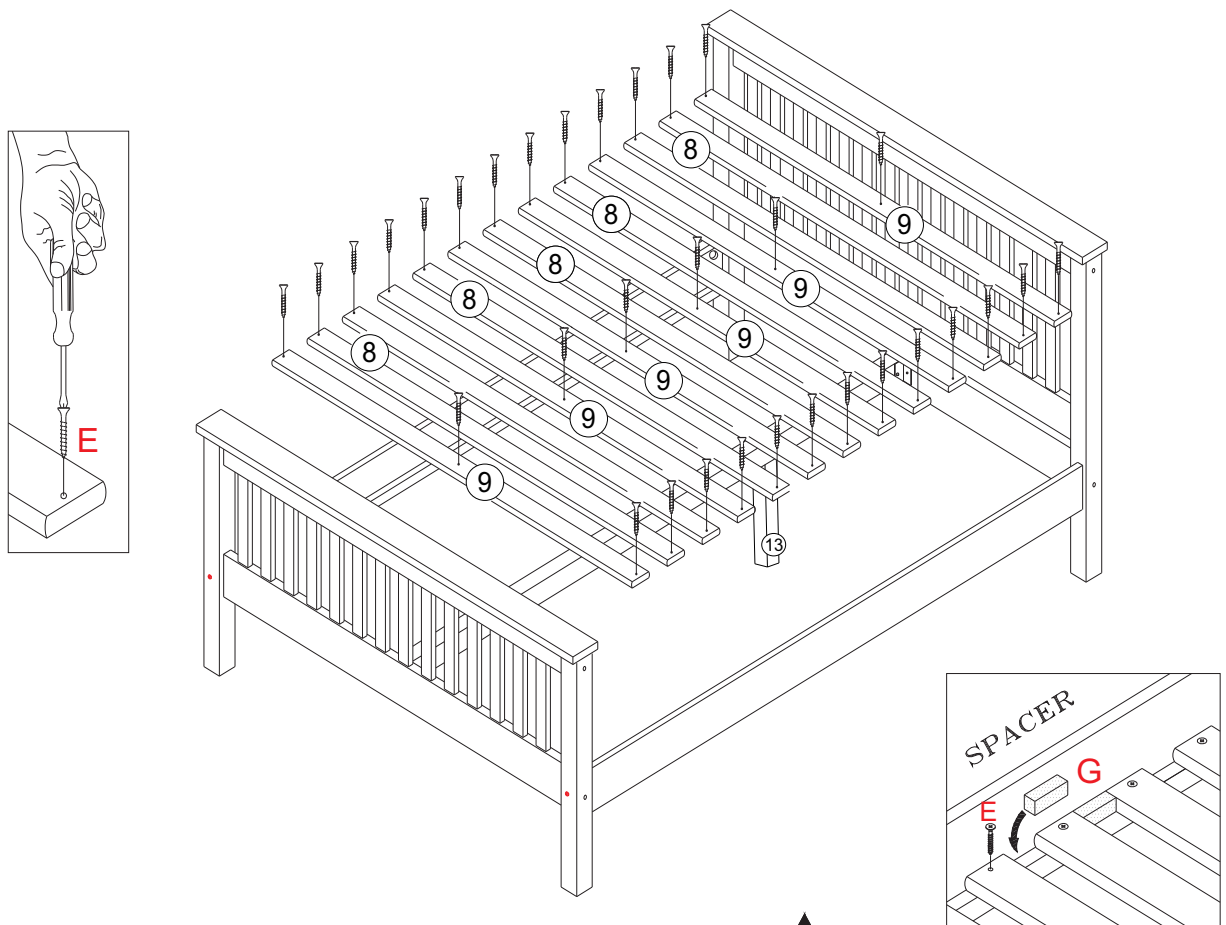

L	 Ø3,5x30mm	06
---	---	----

8

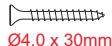

E	 Ø4,0 x 30mm	32
G	 SPACER	02

Please fix the first slats adjacent to the headboard and footboard and work towards the middle of the bed using the spacer (G) as shown to ensure the correct spacing. Fix all the slats to one siderail first then push the second siderail tight against the slats and fix.