

BLACK WOOD GRAIN LISBON 2 DOOR WARDROBE ASSEMBLY INSTRUCTIONS

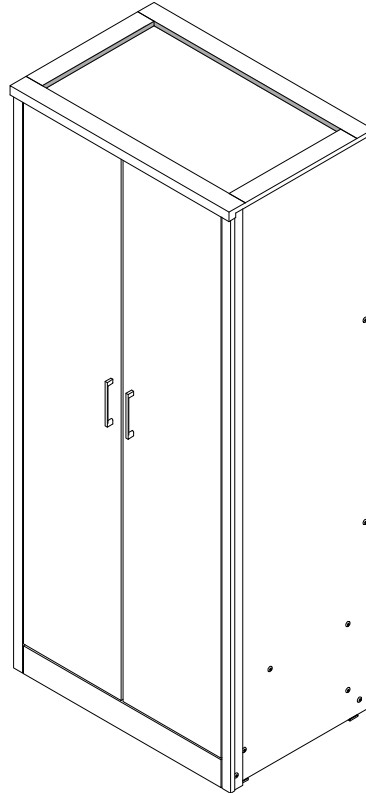
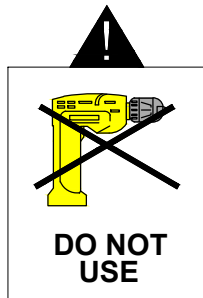

IMPORTANT

PLEASE READ BEFORE YOU CONTINUE FURTHER FOR DOMESTIC USE ONLY

THE PRODUCT YOU HAVE PURCHASED WILL GIVE YOU MANY YEARS OF SERVICE IF YOU FOLLOW THE GUIDELINES FOR ITS SAFE ASSEMBLY AND PERIODIC MAINTENANCE AND CLEANING.

ASSEMBLE ON A SOFT CLEAN SURFACE.

DO NOT USE ANY TOOLS OTHER THAN THOSE SHOWN.

ANY SPANNERS OR ALLEN KEYS REQUIRED ARE INCLUDED WITH THE FITTINGS KIT.

DO NOT FOR ANY REASON USE A POWER TOOL TO ASSEMBLE THIS PRODUCT. ITS USE WILL INVALIDATE ANY CLAIM YOU MAY HAVE AND COULD MAKE THIS PRODUCT UNSAFE.

DEPENDING ON THE AMOUNT OF USE THIS PRODUCT RECEIVES IT MAY BE NECESSARY TO TIGHTEN UP THE FIXINGS FROM TIME TO TIME. THIS IS COMPLETELY NORMAL FOR ANY FLAT PACK FURNITURE. DO NOT OVERTIGHTEN FIXING.

FOR CLEANING, YOU MAY USE A DAMP CLOTH (NOT WET) DO NOT USE POLISH, DETERGENT OR CHEMICAL CLEANERS.



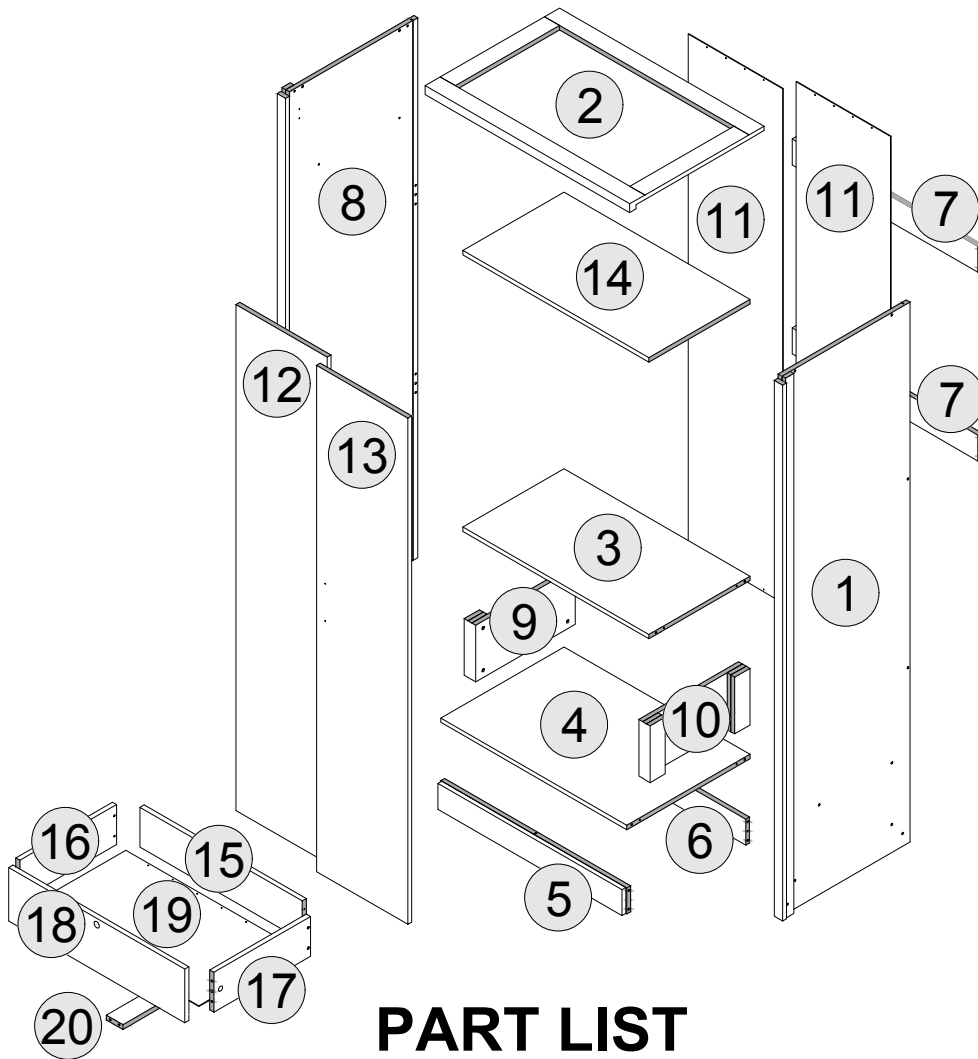









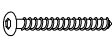

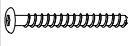
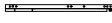









THE SURFACE OF THIS ITEM IS NOT HEAT RESISTANT. ALWAYS USE A PLACE MAT UNDER HOT OR COLD ITEMS TO PREVENT MARKING.

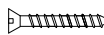

PART LIST

Part Number	Part Code	Part Description	Quantity	Carton
1	S100-101-057-EU2-01	Right Side Panel	1	1/3
2	S100-101-057-EU2-02	Top Panel	1	2/3
3	S100-101-057-EU2-03	Centre Shelf	1	2/3
4	S100-101-057-EU2-04	Base Panel	1	2/3
5	S100-101-057-EU2-05	Base Front Apron	1	2/3
6	S100-101-057-EU2-06	Base Back Apron	1	2/3
7	S100-101-057-EU2-07	Back Crossbars	2	2/3
8	S100-101-057-EU2-08	Left Side Panel	1	1/3
9	S100-101-057-EU2-09	Inner Side Frame 1	1	2/3
10	S100-101-057-EU2-10	Inner Side Frame 2	1	2/3
11	S100-101-057-EU2-11	Back Panel	2	3/3
12	S100-101-057-EU2-12	Door Panel - Left	1	3/3
13	S100-101-057-EU2-13	Door Panel - Right	1	3/3
14	S100-101-057-EU2-14	Shelf Panel	1	2/3
15	S100-101-057-EU2-15	Drawer Back	1	2/3
16	S100-101-057-EU2-16	Drawer Side - Left	1	2/3
17	S100-101-057-EU2-17	Drawer Side - Right	1	2/3
18	S100-101-057-EU2-18	Drawer Front	1	2/3
19	S100-101-057-EU2-19	Drawer Base	1	2/3
20	S100-101-057-EU2-20	Drawer Bottom Support Rail	1	2/3

HARDWARE LIST

A		DOWEL 6x30MM	36 PCS	N		HINGES 7/8	6 PCS
B		BOLT M6x50MM	18 PCS	O		DRAWER RUNNER A (L&R)	2 PCS
C		BOLT M7x60MM	2 PCS	P		DRAWER RUNNER B (L&R)	2 PCS
D		SCREW M3.5x16MM	23 PCS	Q		SCREW M4 X 30MM	2 PCS
E		TACK	22 PCS	R		HANDLE SCREW 19MM	4PCS
F		SCREW M4 X 38MM	4 PCS	S		ALLEN KEY	1 PC
G		HANDLE	2 PCS	T		SCREW M3.5x12MM	12 PCS
H		TAPPING SCREW M8 X 12MM	12 PCS	U		CAM BOLT+CAM NUT	2 SETS
I		HANGING RAIL SUPPORT	2 PCS	V		PLASTIC FOOT	4 PCS
J		HANGING RAIL	1 PC	W		LOCK	1 SET
K		PLASTIC H STRIP	1 PC	X		SCREW M4 X 50MM	8 PCS
L		SHELF SUPPORT	4 PCS	Y		ANTI - TIP STRAP	2 PCS
M		PVC STOPPER	1 PC	Z		SCREW M4 X 16MM	2 PCS

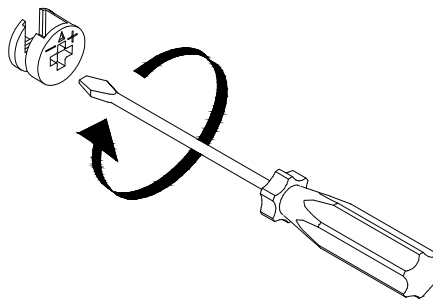

(SCREWDRIVER NOT PROVIDED)

USE A FLAT HEAD SCREWDRIVER TO TIGHTEN THE CAM NUTS. A QUARTER TURN CLOCKWISE IS ALL THAT IS NEEDED.

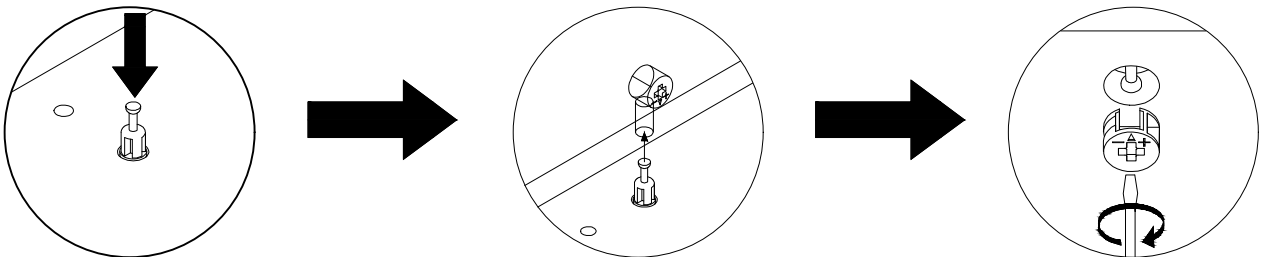

STEP 1 - PUSH CAM BOLT INTO INSERT

STEP 2 - ALIGN THE CAM BOLT WITH THE HOLE AND PUSH TOGETHER UNTIL FLUSH. (MAKE SURE THE ARROW OF THE CAM LOCK IS POINTING TOWARD ON THE EDGE OF THE PANEL.)



STEP 3 - THE HEAD OF THE BOLT GOES INTO THE WIDE MOUTH OF THE CAM LOCK. YOU THEN TURN THE LOCK SO THE NARROW PART CLOSES OVER THE BOLT.

STEP 1

PARTS REQUIRED

1 - RIGHT SIDE PANEL	x1
8 - LEFT SIDE PANEL	x1

HARDWARE REQUIRED

I		02
L		04
T		04

TOOLS REQUIRED

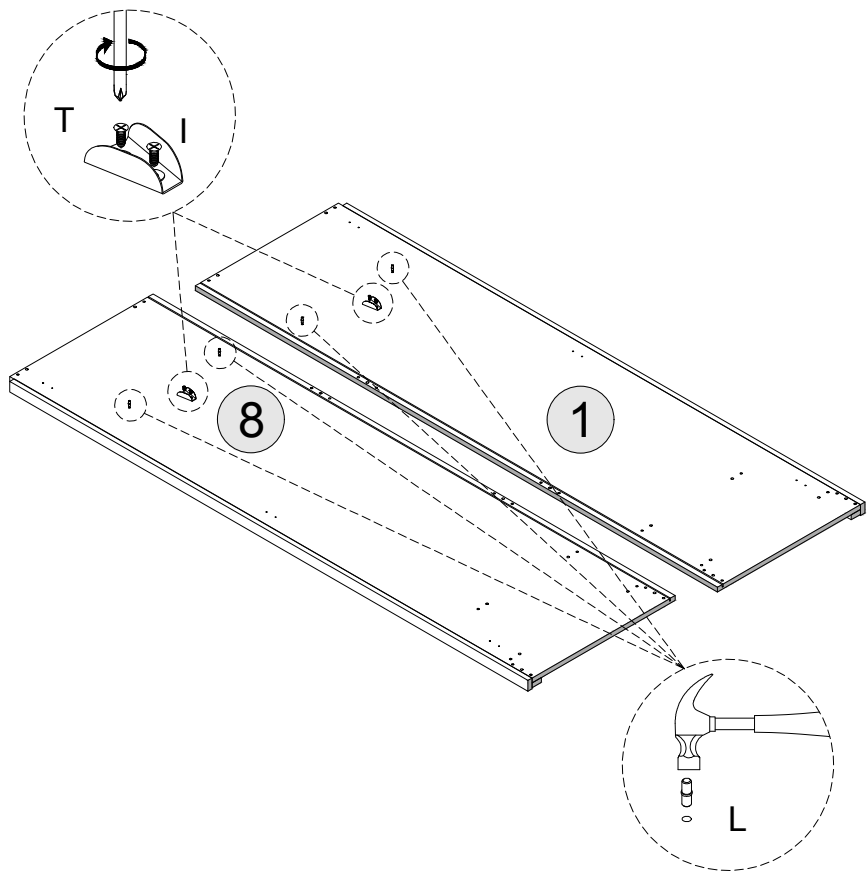
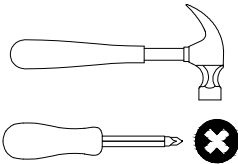

STEP 2

PARTS REQUIRED

3 - CENTRE SHELF	x1
4 - BASE PANEL	x1
7 - BACK CROSSBARS	x2

HARDWARE REQUIRED

A		16
---	---	----

TOOLS REQUIRED

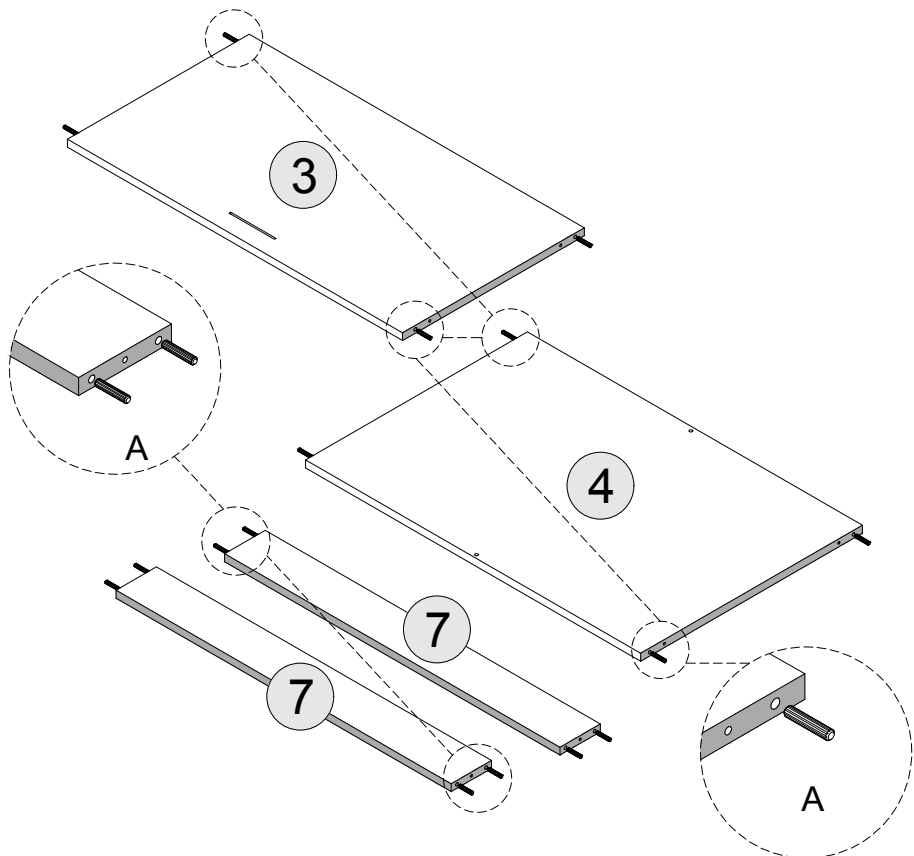



STEP 3

PARTS REQUIRED

2 - TOP PANEL	x1
5 - BASE FRONT APRON	x1
6 - BASE BACK APRON	x1

HARDWARE REQUIRED

A		14
D		01
M		01

TOOLS REQUIRED

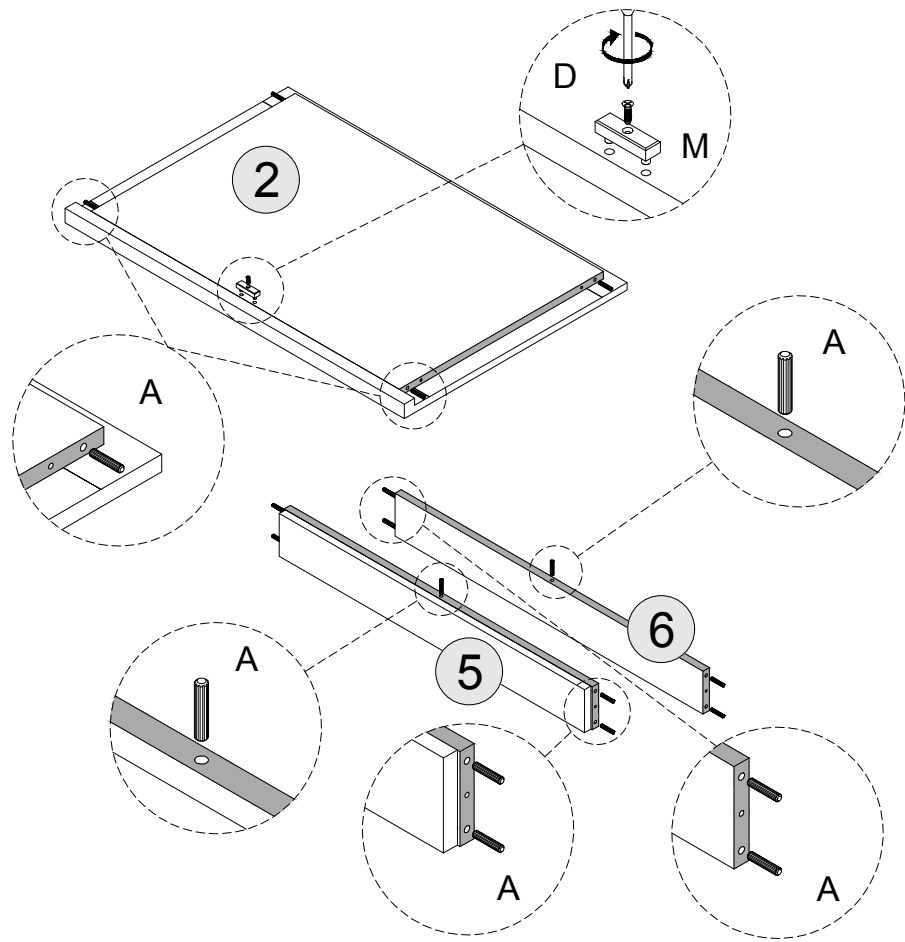
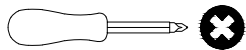



STEP 4

PARTS REQUIRED

9 - INNER SIDE FRAME 1	x1
10 - INNER SIDE FRAME 2	x1

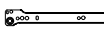
HARDWARE REQUIRED

O		02
T		08

TOOLS REQUIRED

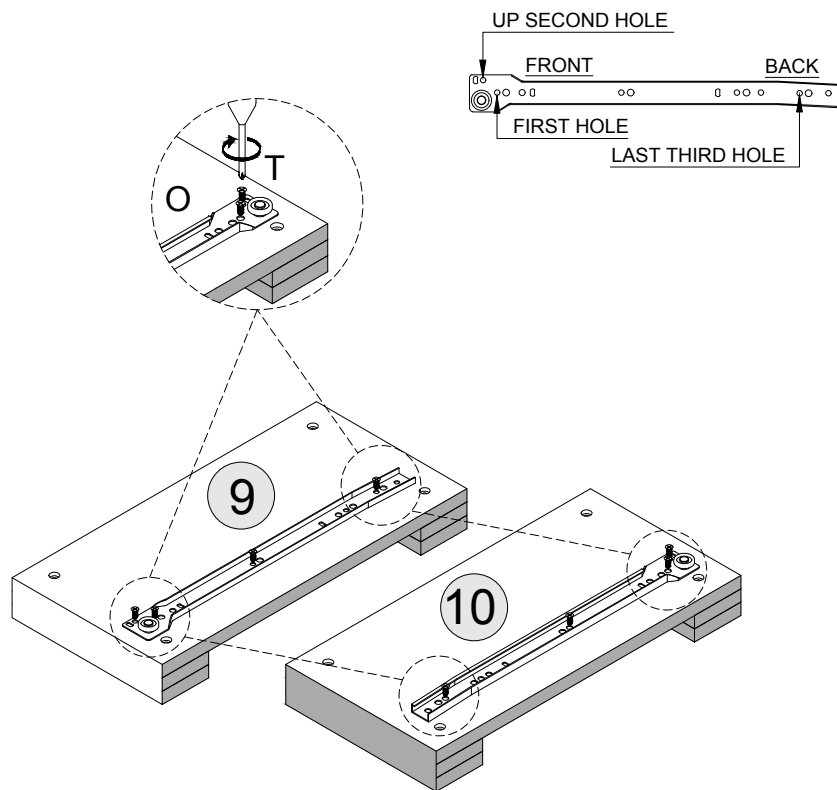
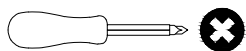

STEP 5

PARTS REQUIRED

1 - RIGHT SIDE PANEL	x1
2 - TOP PANEL	x1
3 - CENTRE SHELF	x1

HARDWARE REQUIRED

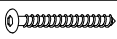
B		04
---	---	----

TOOLS REQUIRED

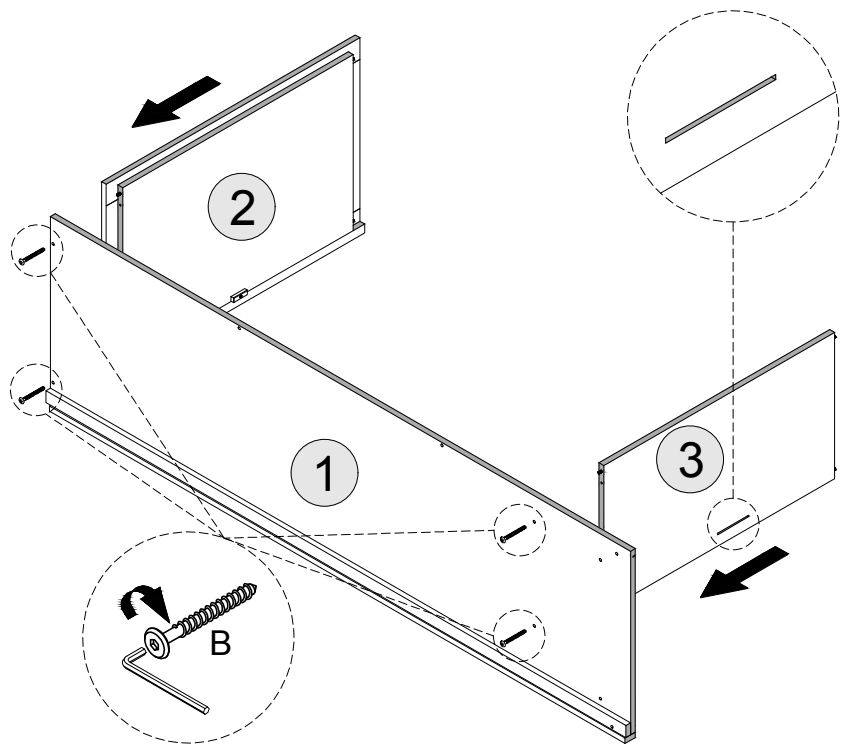

STEP 6

PARTS REQUIRED

4 - BASE PANEL	x1
5 - BASE FRONT APRON	x1
6 - BASE BACK APRON	x1

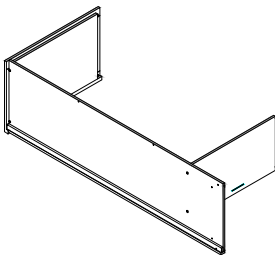

HARDWARE REQUIRED

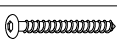
B		03
---	---	----

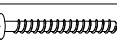
B		01
---	---	----

TOOLS REQUIRED

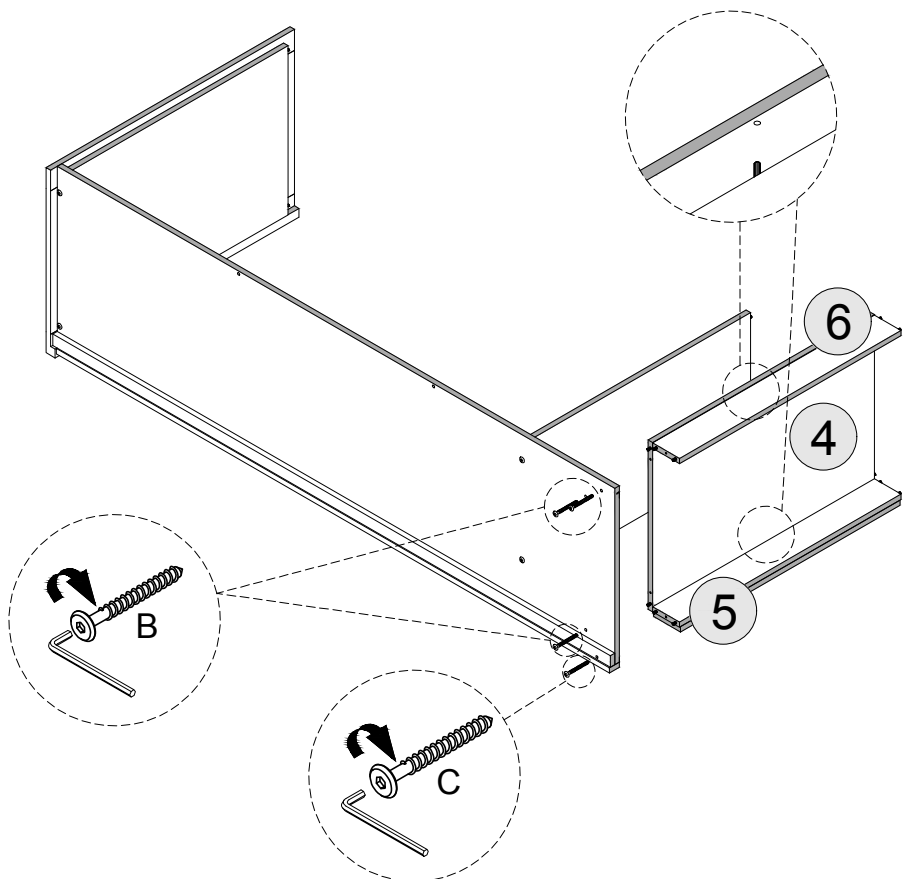

STEP 7

PARTS REQUIRED

7 - BACK CROSSBARS x2

8 - LEFT SIDE PANEL x1

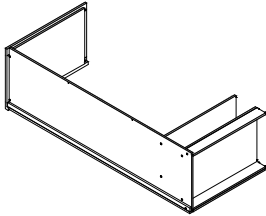

HARDWARE REQUIRED

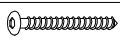
B  11

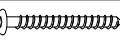
B  01

TOOLS REQUIRED

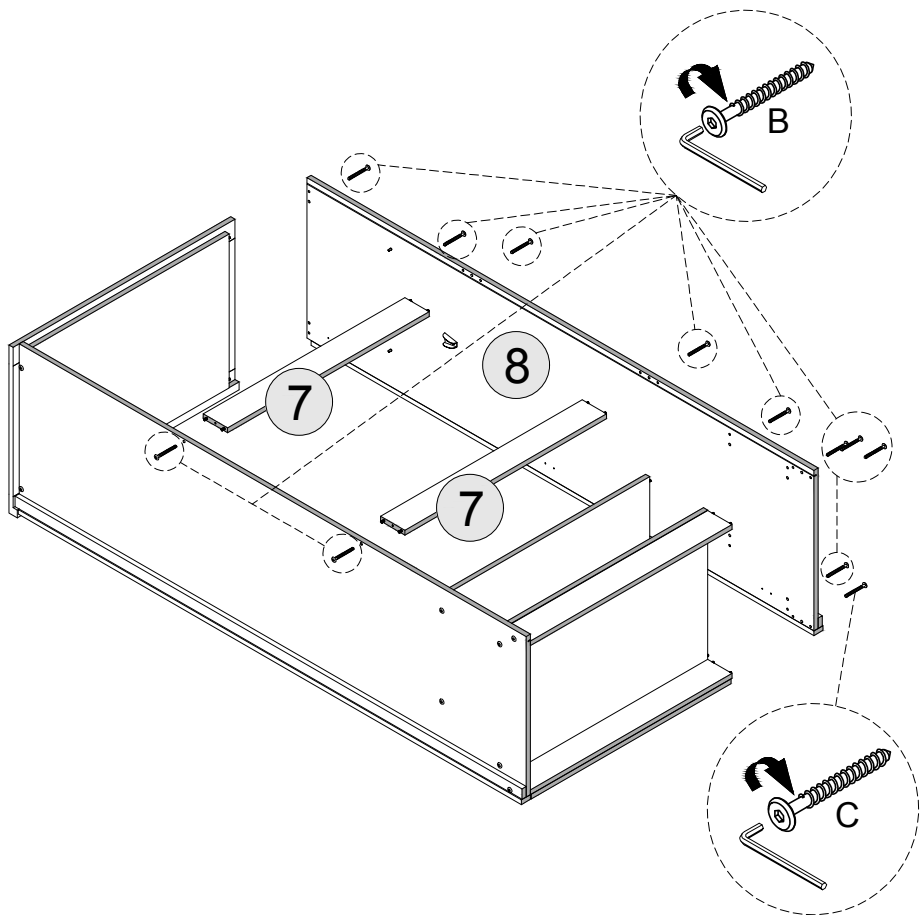
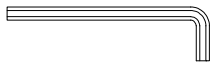

STEP 8

PARTS REQUIRED

9 - INNER SIDE FRAME 1 x1

10 - INNER SIDE FRAME 2 x1

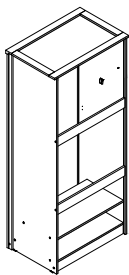

HARDWARE REQUIRED

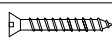
X  08

TOOLS REQUIRED

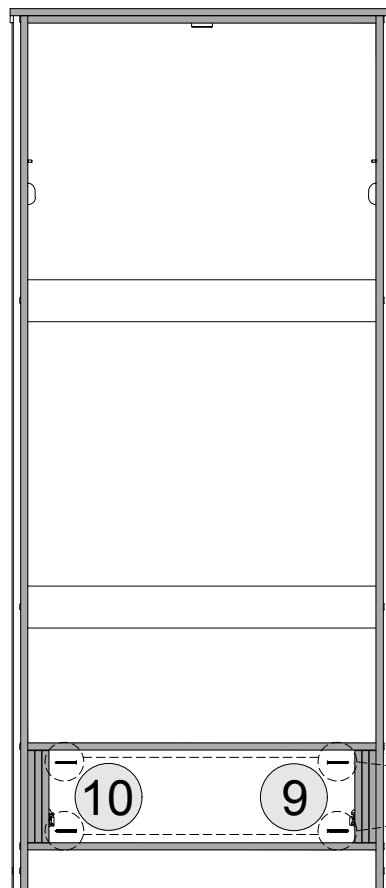
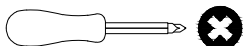

BACK SIDE VIEW

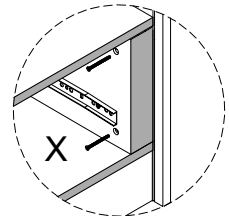

BACK SIDE VIEW

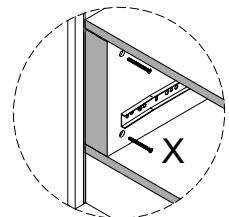

SIDE VIEW

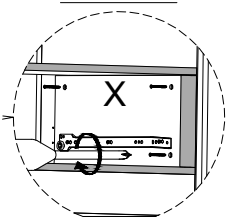



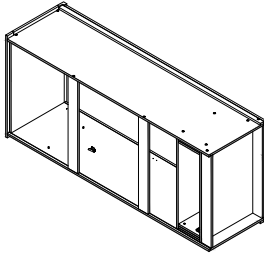

STEP 9

PARTS REQUIRED

11 - BACK PANEL x2



HARDWARE REQUIRED

- D  04
- E  16
- K  01
- V  04

TOOLS REQUIRED

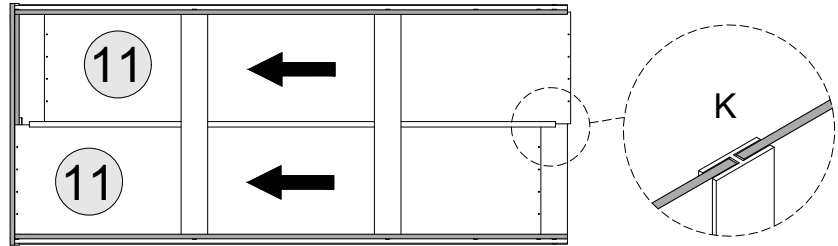
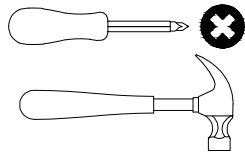

PLEASE INSERT THE BACK PANEL INTO THE UNIT

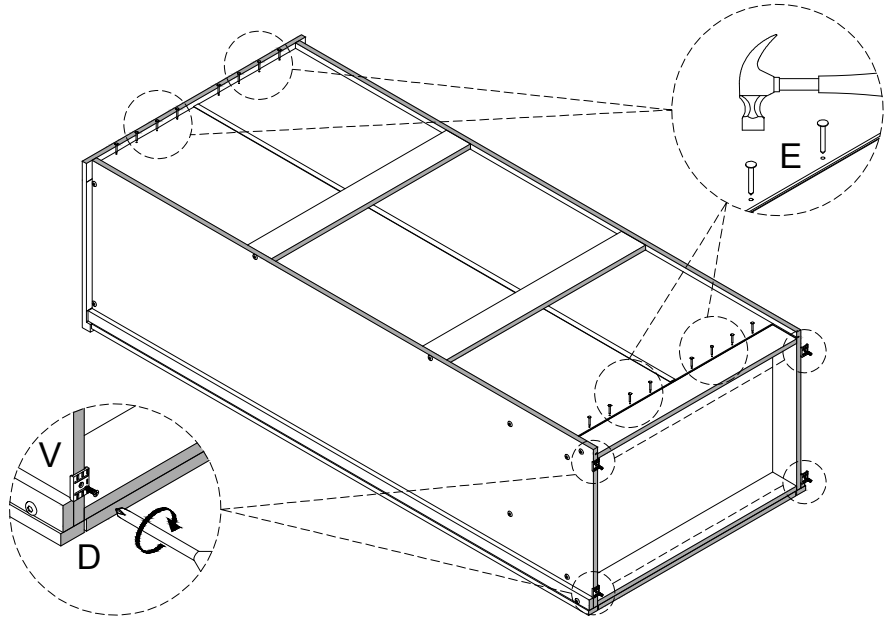





STEP 10

PARTS REQUIRED

12 - DOOR PANEL - LEFT x1

13 - DOOR PANEL - RIGHT x1

HARDWARE REQUIRED

- D  12
- G  02
- N  06
- R  04

TOOLS REQUIRED

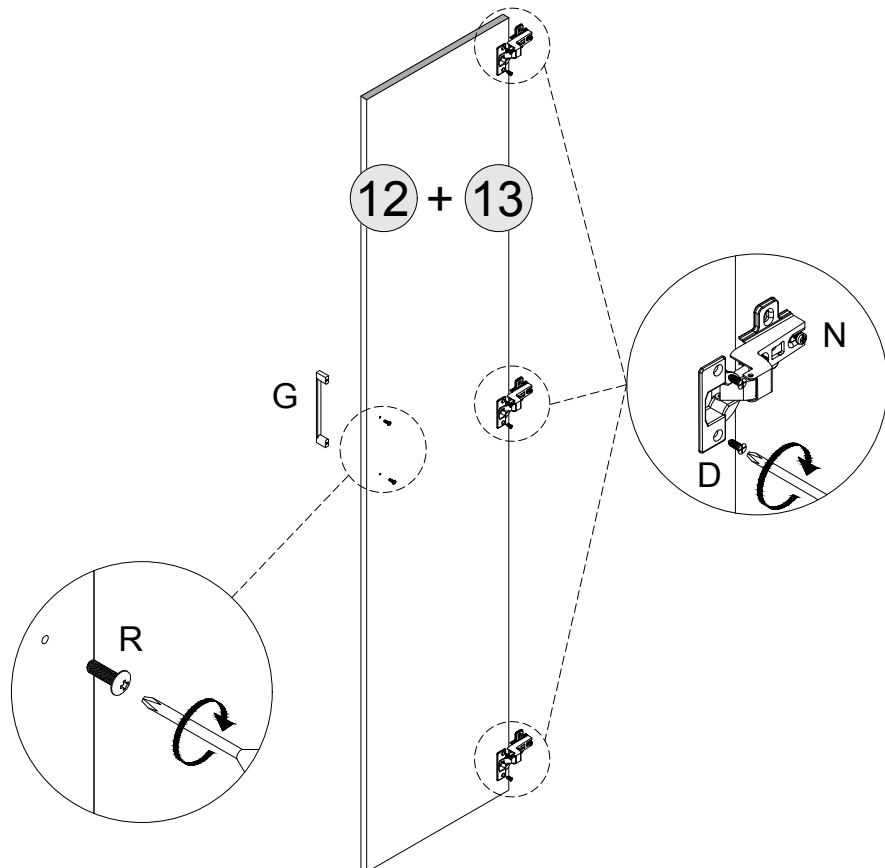
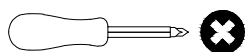

STEP 11

PARTS REQUIRED

12 - DOOR PANEL - LEFT x1

13 - DOOR PANEL - RIGHT x1

14 - SHELF PANEL x1

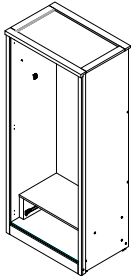

HARDWARE REQUIRED

H  12

J  01

TOOLS REQUIRED

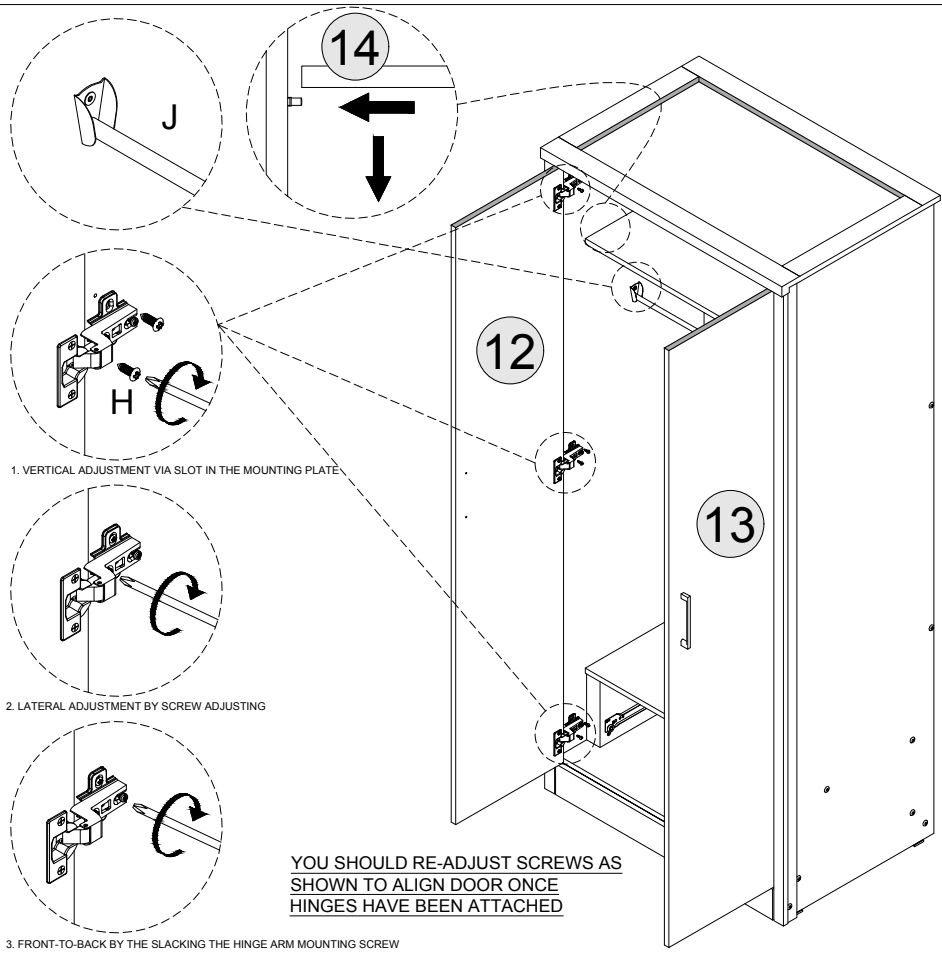
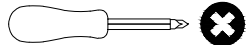

STEP 12

PART REQUIRED

15 - DRAWER BACK x1

16 - DRAWER SIDE - LEFT x1

17 - DRAWER SIDE - RIGHT x1

18 - DRAWER FRONT x1

HARDWARE REQUIRED

A  04

F  04

U  02

TOOLS REQUIRED

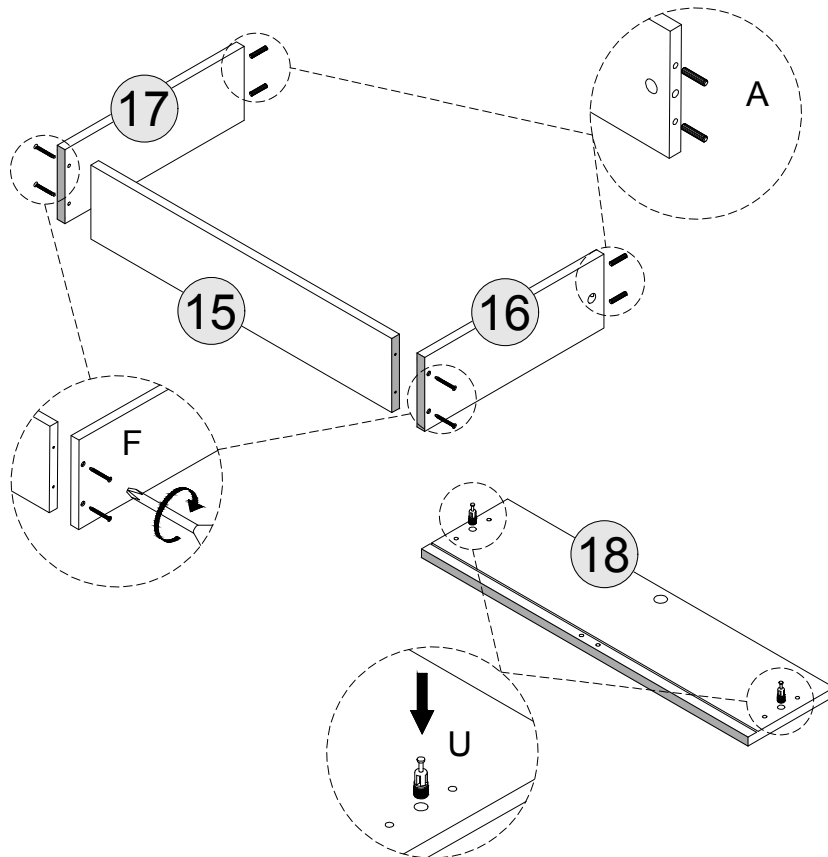
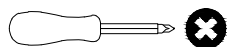

STEP 13

PARTS REQUIRED

19 - DRAWER BASE x1

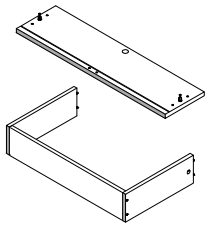

HARDWARE REQUIRED

- | | | |
|---|--|----|
| E | | 06 |
| U | | 02 |
| W | | 01 |

TOOLS REQUIRED

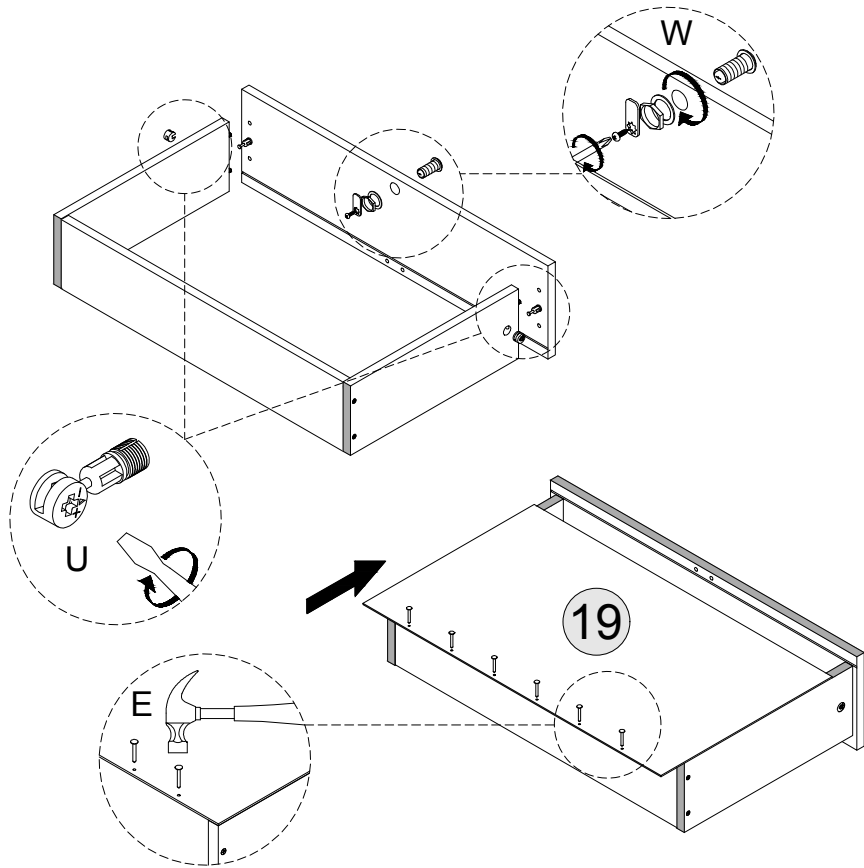
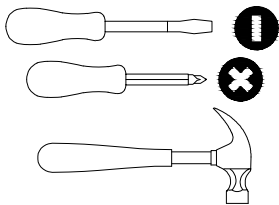

STEP 14

PART REQUIRED

20 - DRAWER BOTTOM SUPPORT RAIL X1

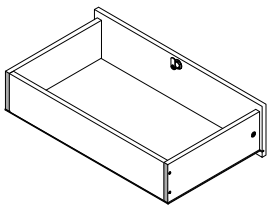

HARDWARE REQUIRED

- | | | |
|---|--|----|
| A | | 02 |
| D | | 06 |
| P | | 02 |
| Q | | 02 |

TOOLS REQUIRED

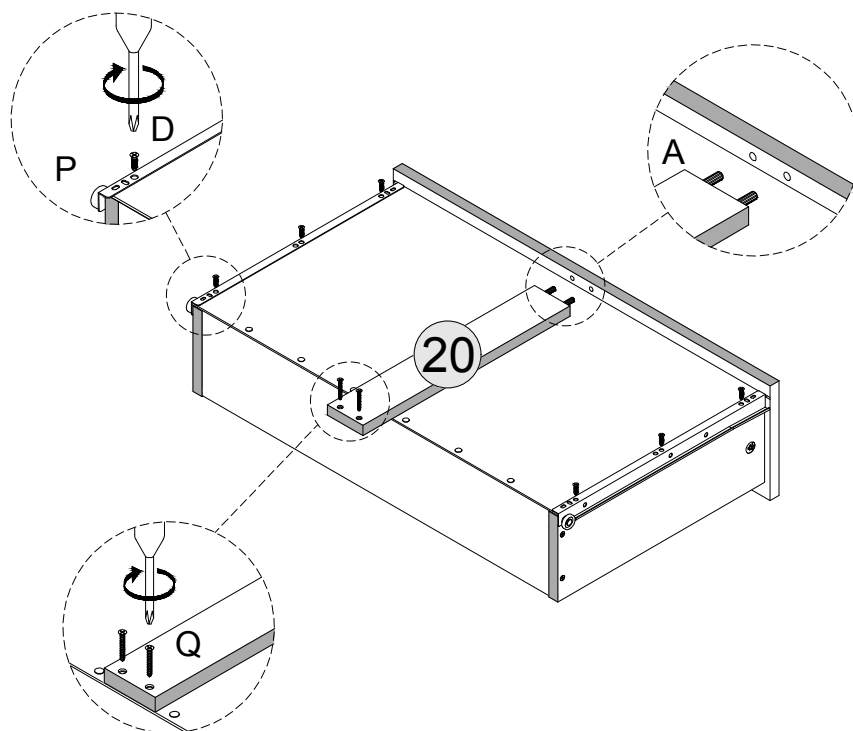
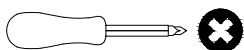

STEP 15

PARTS REQUIRED

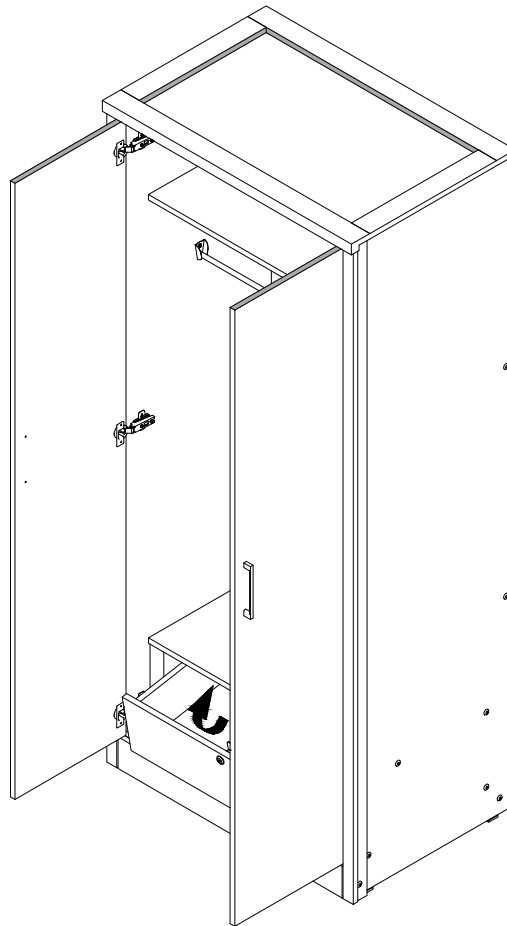
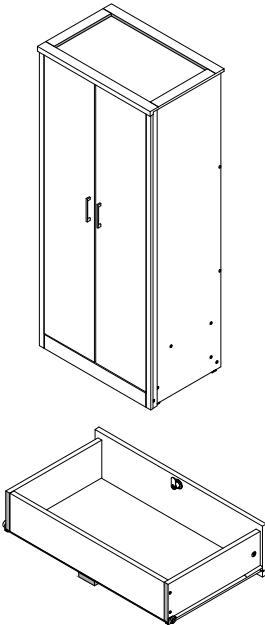

STEP 16

PART REQUIRED

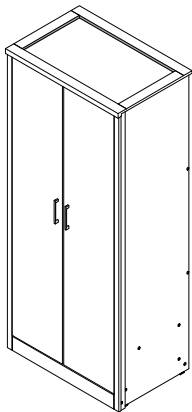

HARDWARE REQUIRED

Y		02
Z		02

TOOLS REQUIRED

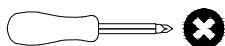

WARNING

Serious or fatal injuries can occur from furniture tipping over. To prevent the furniture from tipping over we recommend that it is permanently fixed to the wall.

Wall fixings are not supplied with this product as different wall materials require different types of fixing devices. Please make sure you use fixings suitable for the walls in your home.

