

Julian Bowen Limited

Shaker Bed LFE 135cm

Assembly Instructions

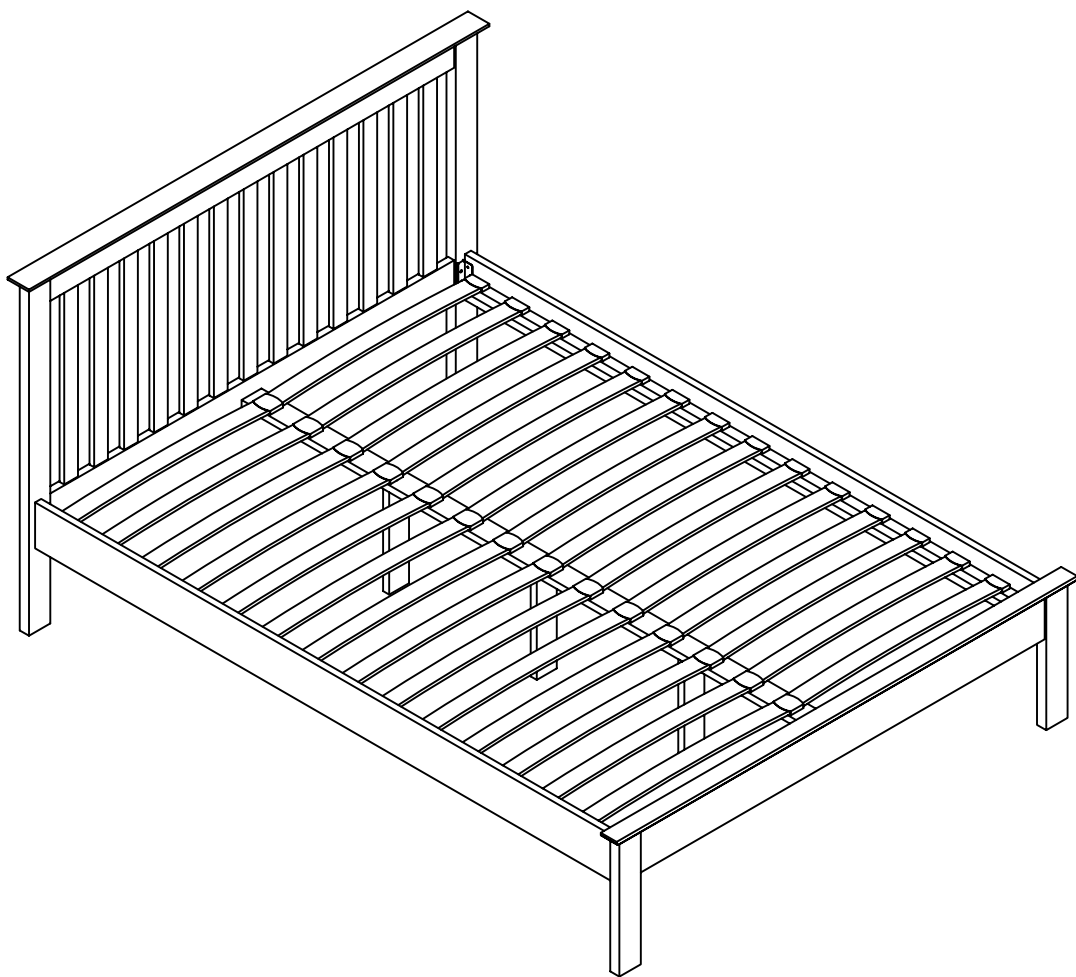

VERSION:160118

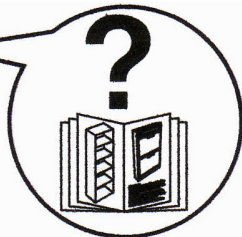
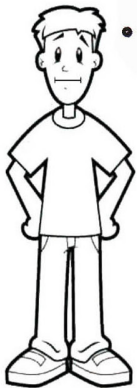
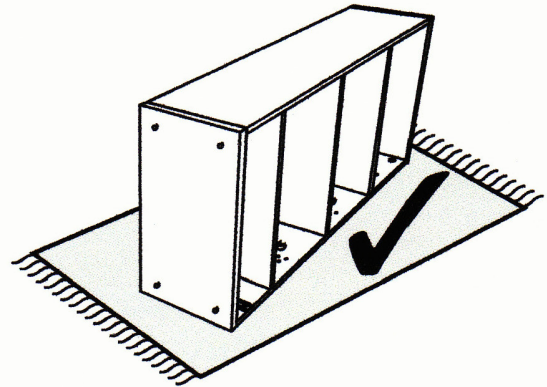
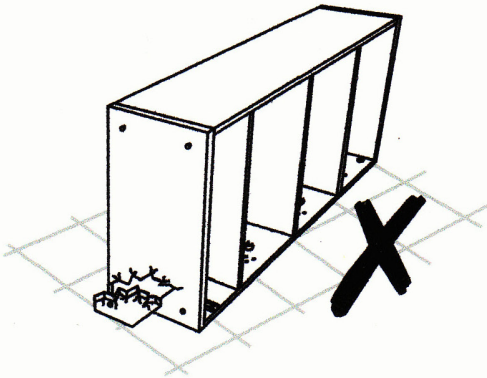
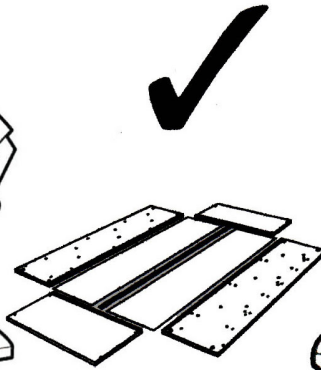
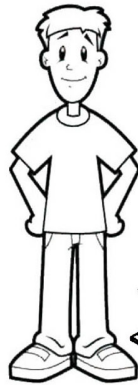
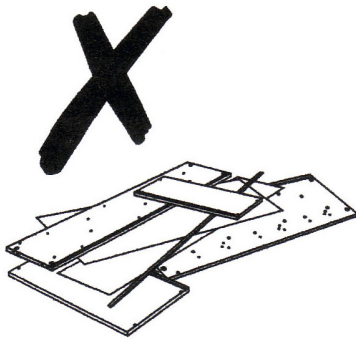
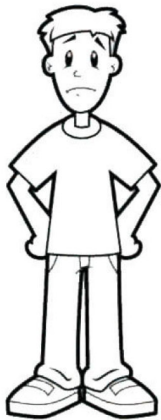
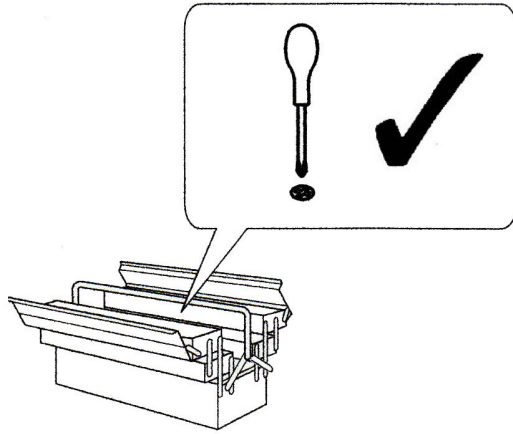

Julian Bowen Limited
(01623 727374)

HARDWARE

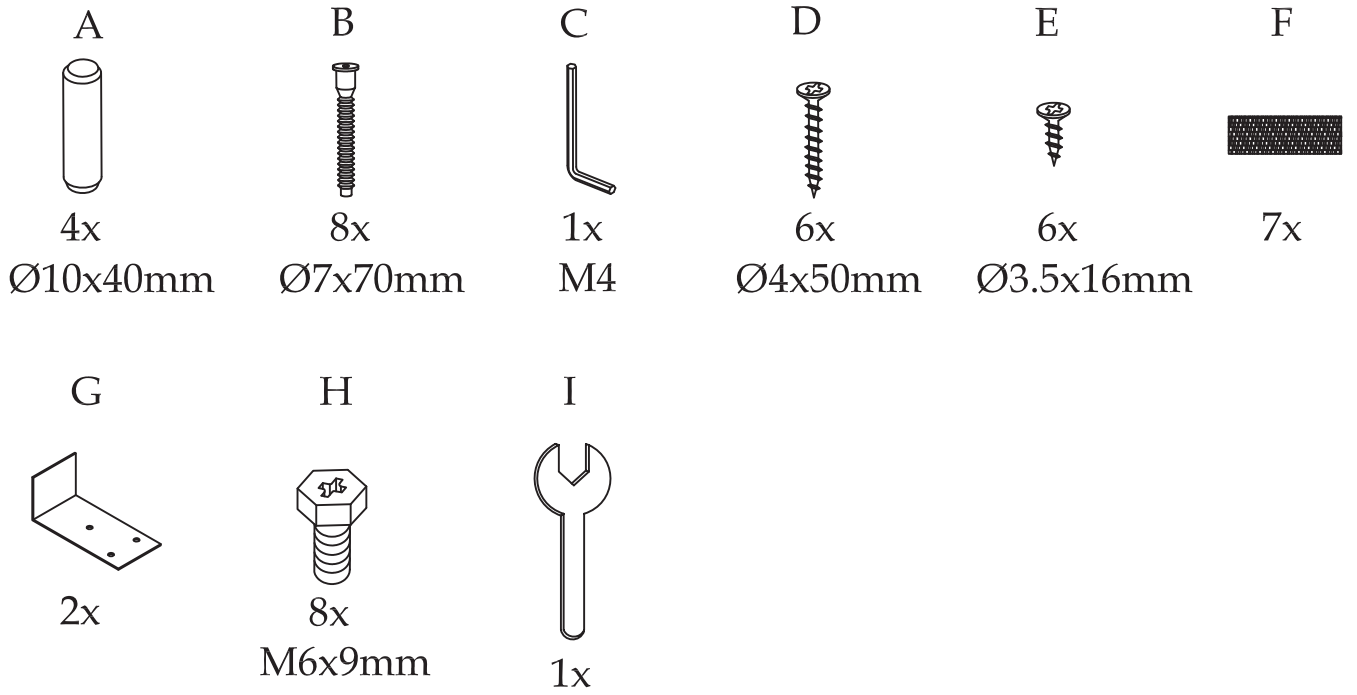

PARTS

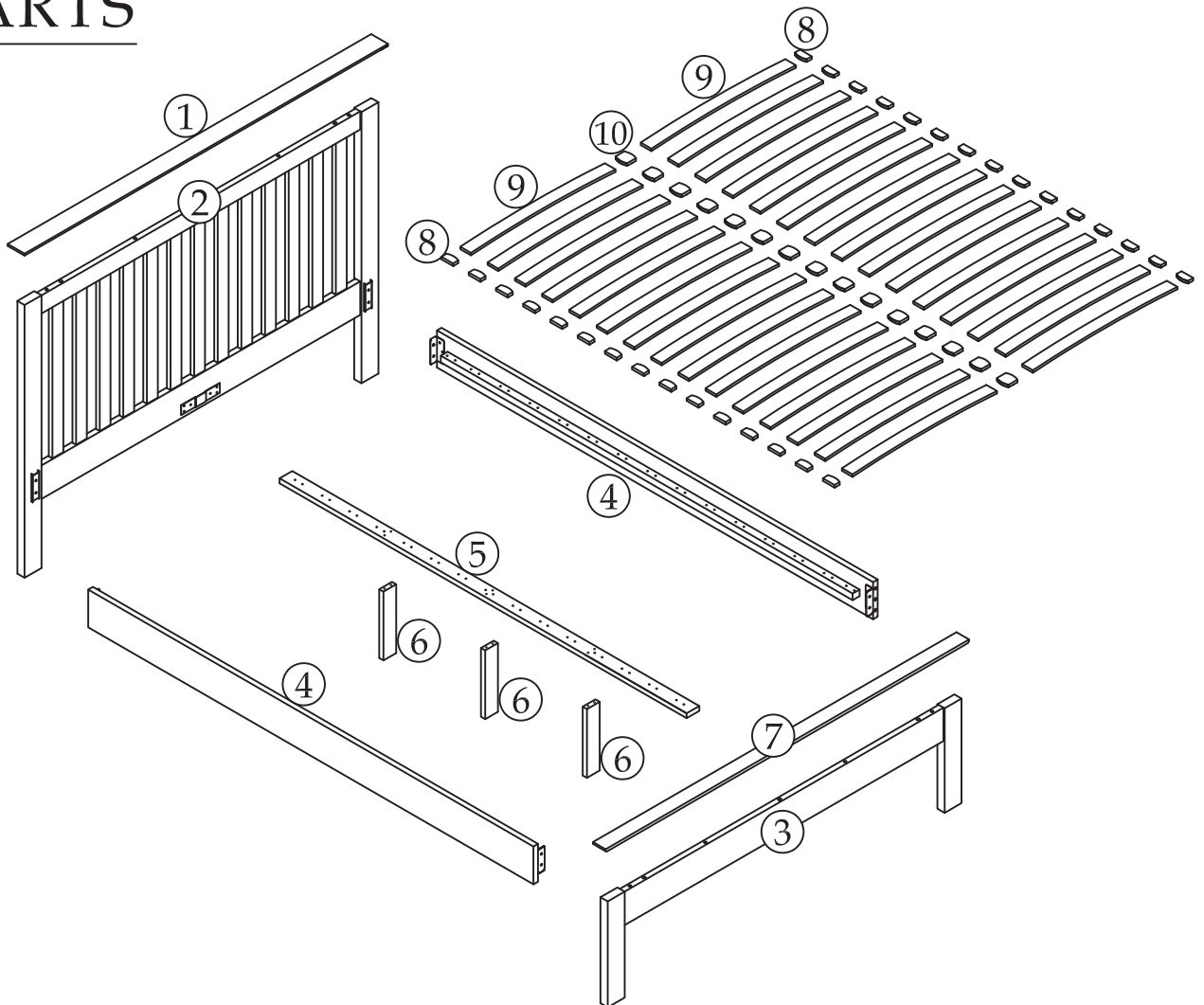

Safety Advice

Please take the time to carefully read through the whole of these instructions before you commence.

Keep these instructions for future reference.

Unpack, inspect and check off all of the contents.

Please dispose of all packaging safely.

Small component parts could choke a child if swallowed.

We strongly recommend that you keep children well away from the work area.

It would be sensible to lay a sheet or blanket on the floor where you intend to work to avoid scratching this product and to protect your floor.

This product is heavy. Take extreme care when lifting to avoid personal injury or damage to the product.

Assemble the product as close to its intended final position in the room as possible.



HANDY HINT: If you keep the hardware in a bowl during assembly you will be less likely to lose them.

1

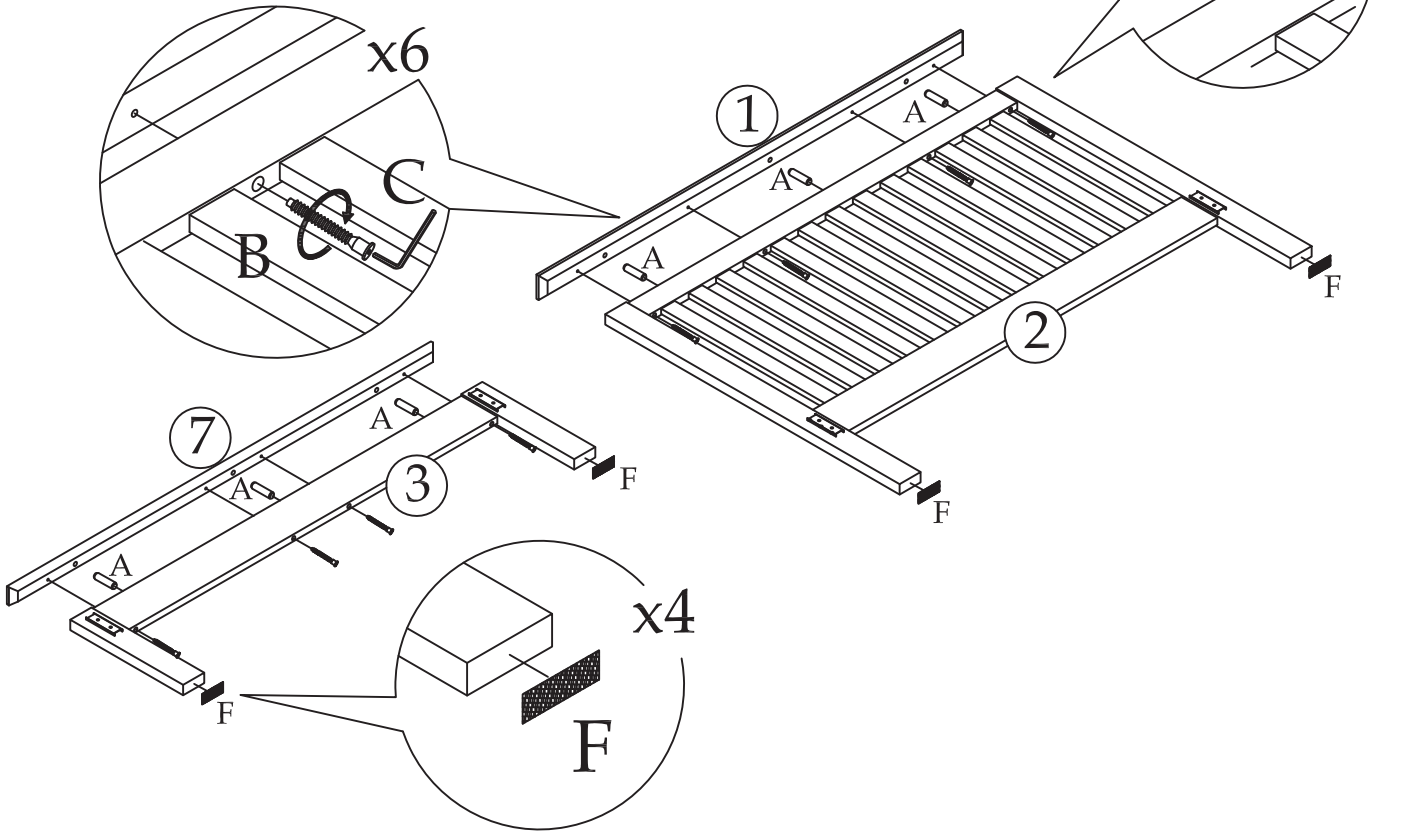
Ax6		Bx8		Cx1	
Fx4					



2

Hx8	
Ix1	

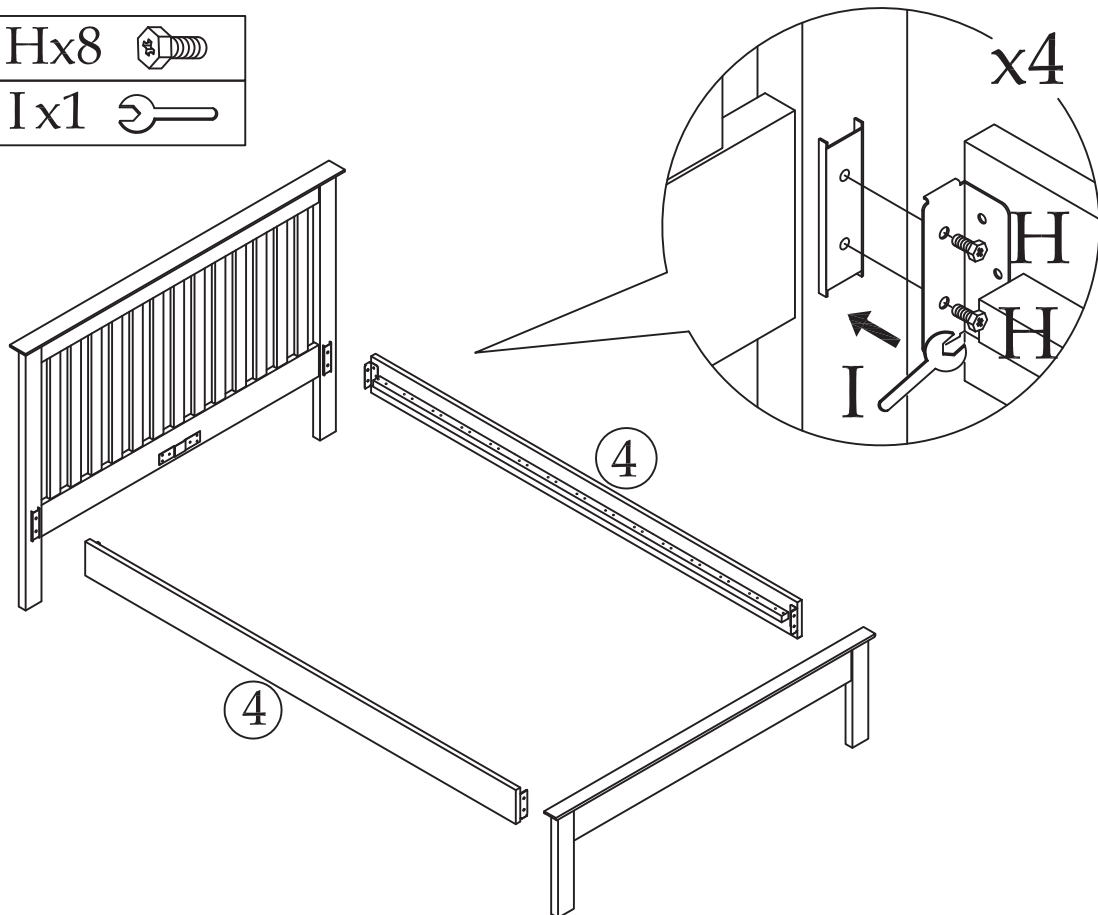

3

Ex6  Fx3  Gx2 

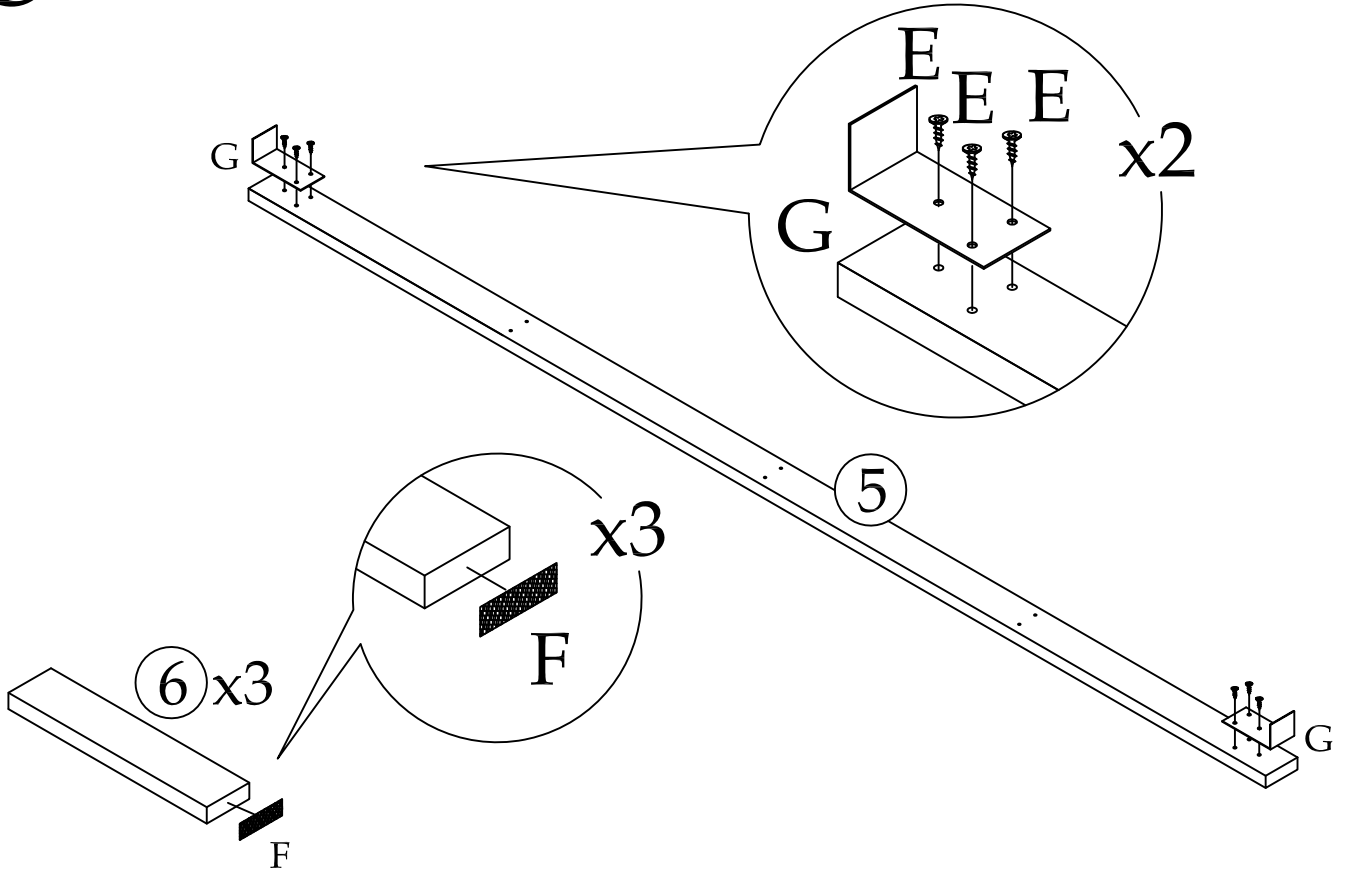

4

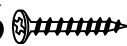
Dx6 

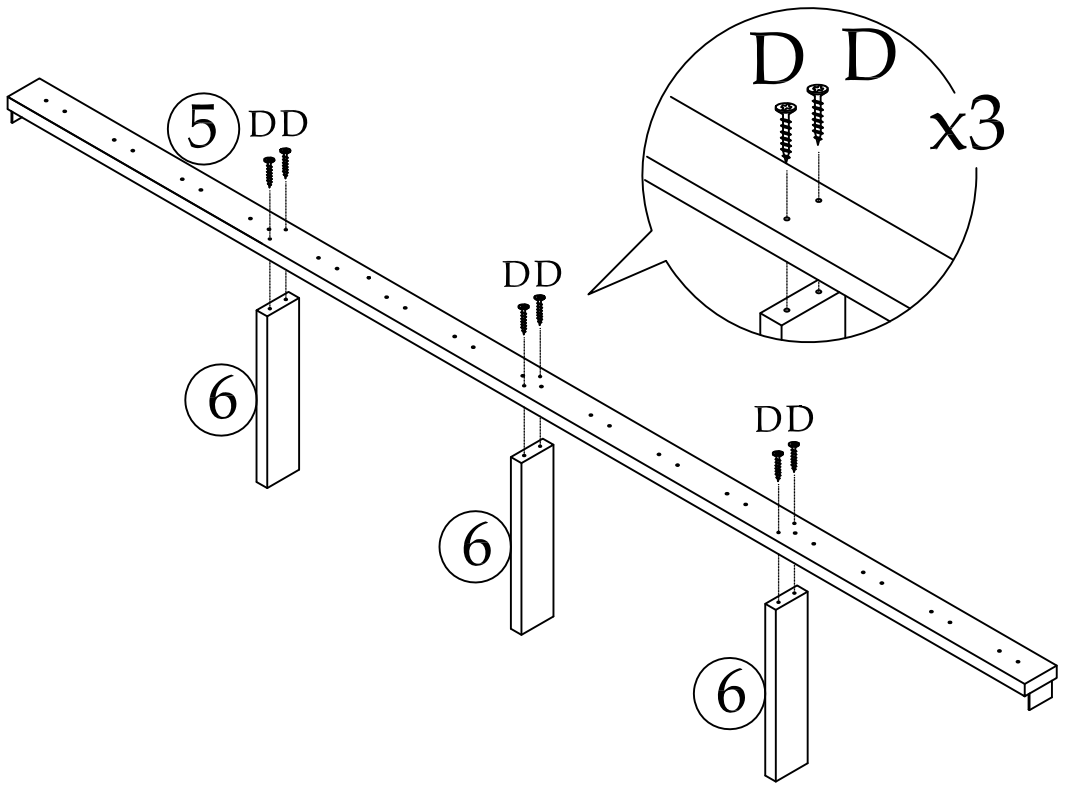

5

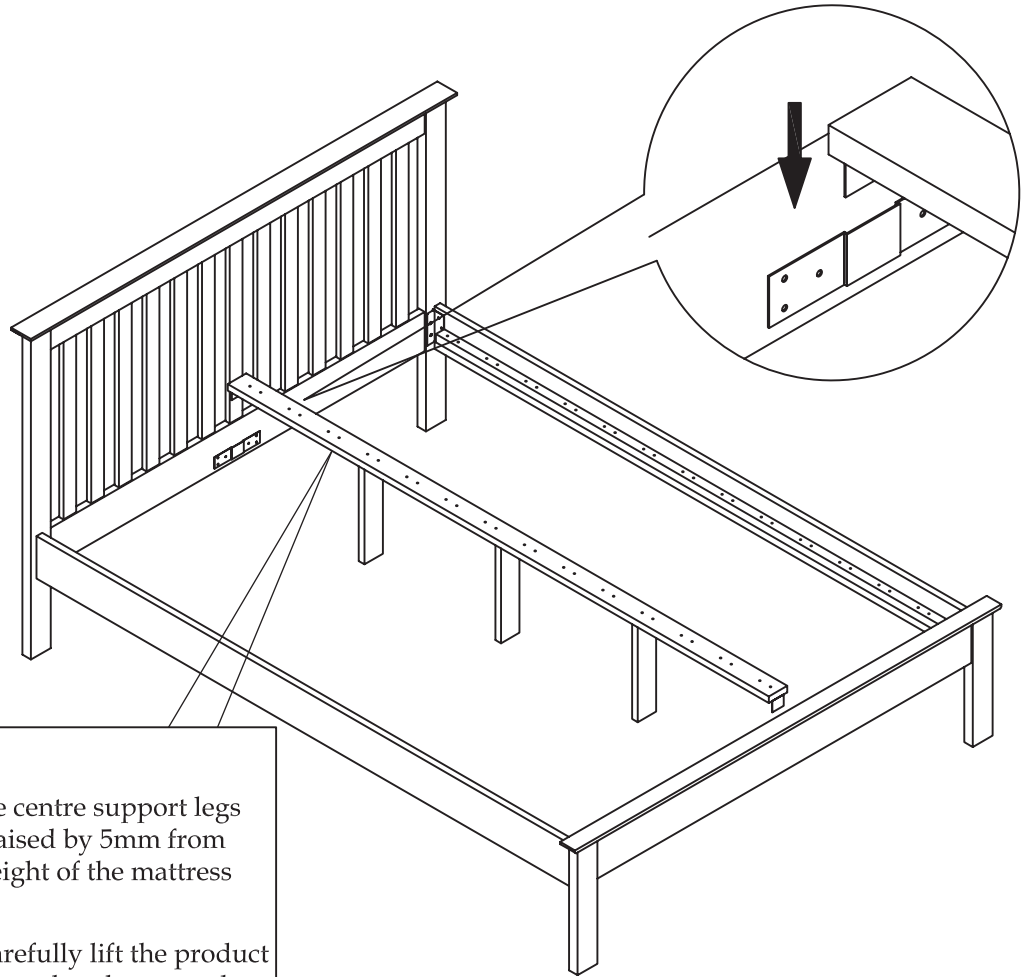

URGENT WARNING

When correctly adjusted the centre support legs on this product should be raised by 5mm from the floor with the added weight of the mattress and bedding.

If the bed is to be moved, carefully lift the product rather than dragging to ensure that the centre legs do not become twisted and buckle.

6

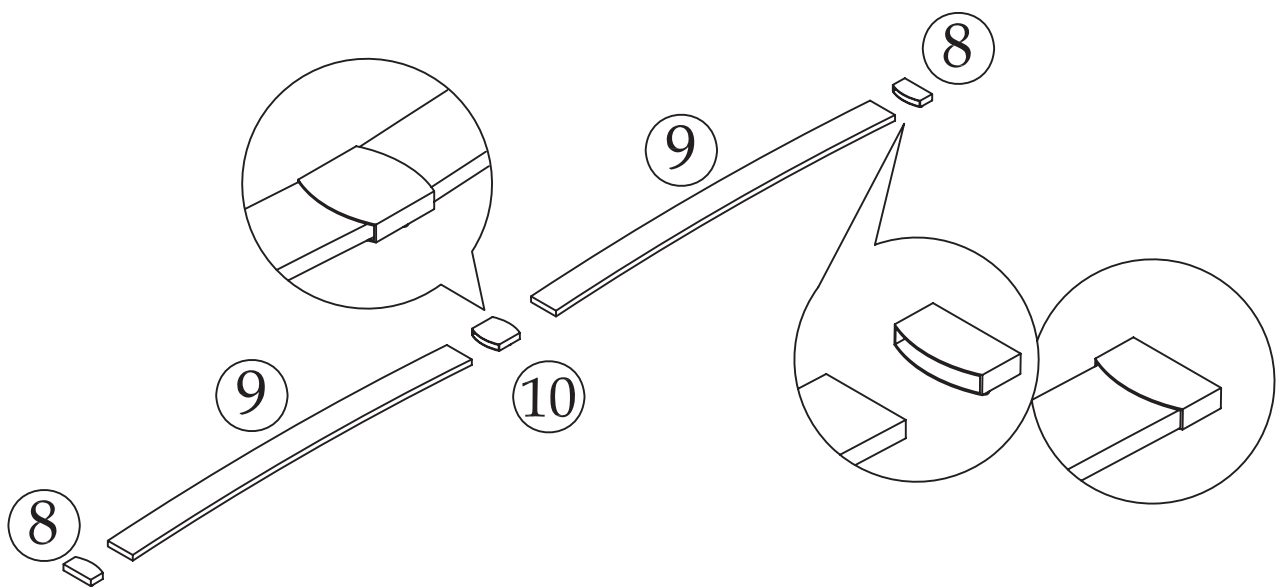

7

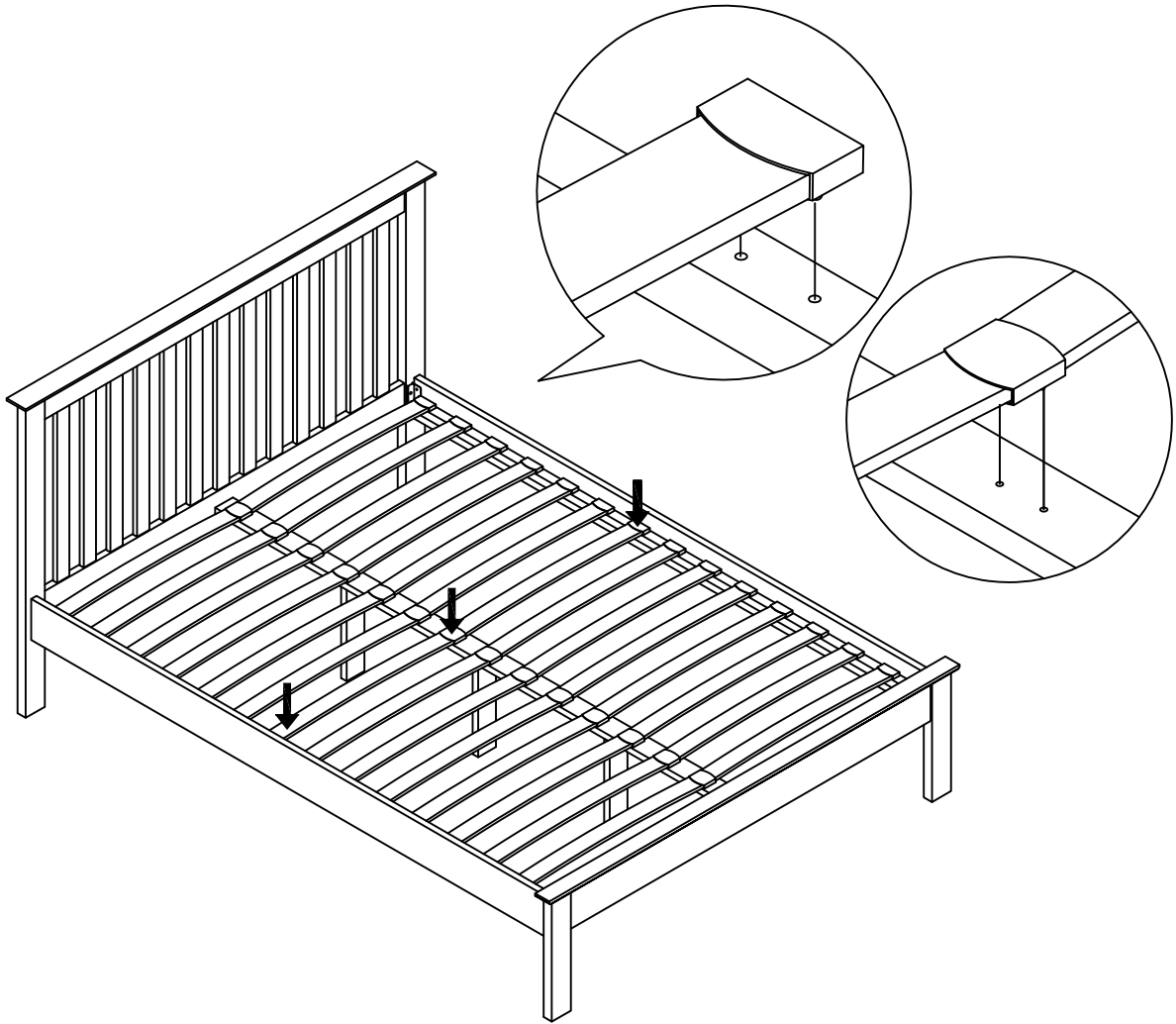

8

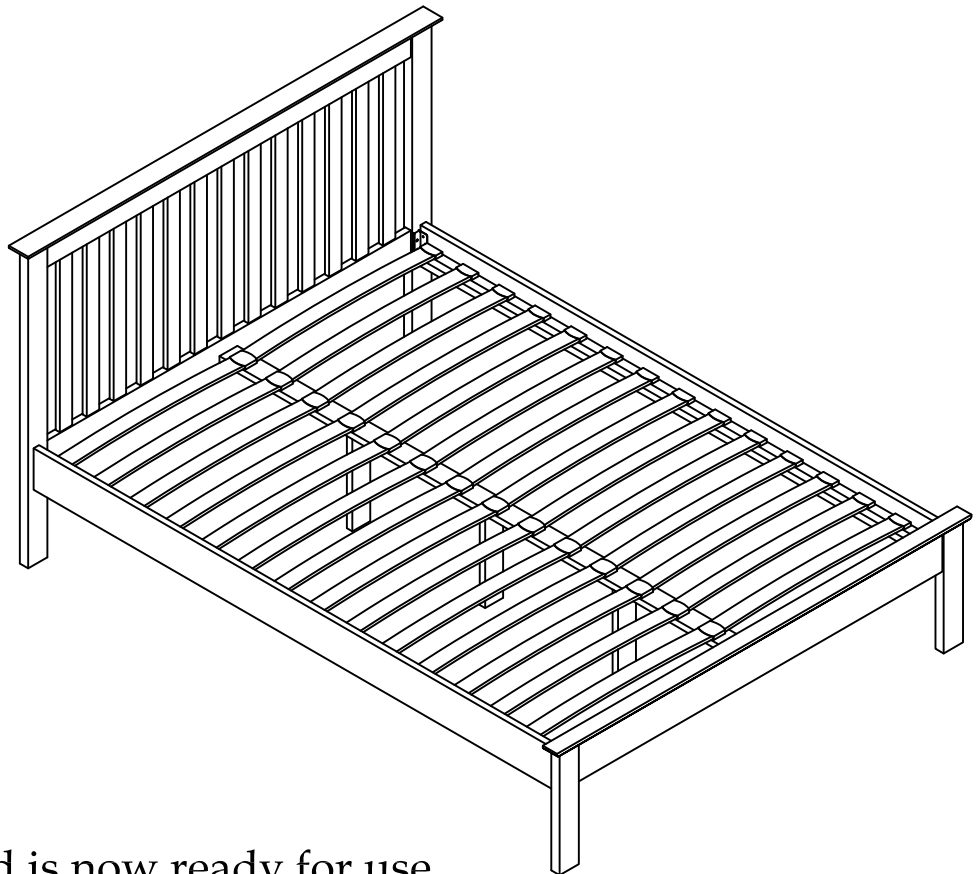

Your Shaker Bed is now ready for use.

General Care

Wipe clean with a slightly damp soft cloth.

Avoid the use of all household cleaners and abrasives.

When moving your furniture, carefully lift into place.

Never drag or push the pieces across the floor as this will cause damage to the joints and could result in failure to the product that will invalidate the warranty.

Recommendations

Periodical re-tightening of fixings.

Warning

This unit is heavy. Please use an assistant when lifting.

Notes

We've tried to make this piece of furniture as easy to assemble as possible. In the unlikely event that you have problems putting it together or have damaged or missing pieces, please contact our customer services on 01623 727374

Julian Bowen Limited

Bentinck House , Park Lane Business Park, Kirkby-in-Ashfield, Notts, NG17 9LE

www.julian-bowen.co.uk